

# Maxillofacial Surgery Instruments



**acme** surgical®

[www.acmesurgical.com](http://www.acmesurgical.com)



# SCALPEL HANDLES

- Ручки для скальпелей
- Manches de bistouris
- Skalpellgriffe

- Ручки для скальпелів
- Mangos de bisturi
- مشرط مقابض



33.1445  
Fig.3  
12.7cm 5"



33.1446  
Fig.3G  
12.7cm 5"



33.1447  
Fig.3L  
21cm 8 1/4"



33.1448  
Fig.7  
16.5cm 6 1/2"



33.1449  
Fig.4  
13.7cm 5 1/2"



33.1450  
Fig.4L  
21.8cm 8 1/2"



33.1451  
11 cm  
4 1/4"



33.1452  
11.5cm  
4 1/2"



33.1453  
12.7 cm  
5"



33.1454  
12.7 cm  
5"



33.1455  
13.3 cm  
5 1/4"



33.1456  
12 cm  
4 3/4"



33.1457  
Fig. 5



33.1458  
Fig. 5A



## SCALPEL HANDLES

- Ручки для скальпелей
- Manches de bistouris
- Skalpellgriffe

- Ручки для скальпелів
- Mangos de bisturi
- مشرط مقابض



**33.1459**  
Orientable blade  
Scalpel handle 16 cm

Регульоване лезо  
Ручний скальпель



Scalpel blade remover



**33.1460**  
16.5 cm  
Kit of scalpel blade remover  
and orientable blade scalpel  
handle  
Набір із знімача леза  
скальпелів та ручний  
скальпель з регульованим  
лезом Знімач леза  
скальпеля



**33.1461**  
13.5 cm



**33.1462**  
Fig. 4



**33.1463**  
Fig. 7



# NEEDLE HOLDERS

- Иглодержатели
- Porte-aiguilles
- Nadelhalter

- Голкотримачі
- Porta-agujas
- أصحاب إبرة

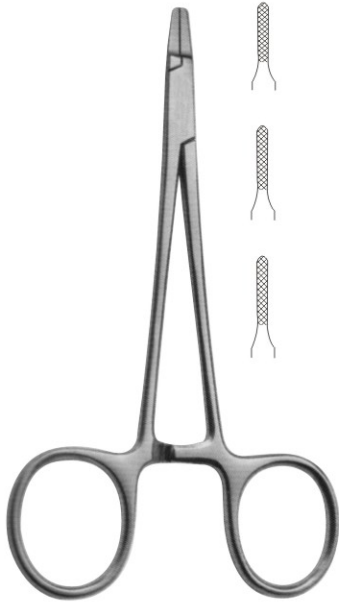

**Castroviejo**  
 33.1464 130mm  
 33.1465 150mm  
 33.1466 180mm



**Halsey**  
 33.1467 130mm



**Baumgartner**  
 33.1468 130mm



**Derf**  
 33.1469 120mm



**Delicate**  
 33.1470 150mm



**Adson**  
 33.1471 170mm



**Mayo-Hegar**  
 33.1472 130mm  
 33.1473 160mm  
 33.1474 180mm  
 33.1475 200mm



**Crile Wood**  
 33.1476 150mm



# NEEDLE HOLDERS

- Иглодержатели
- Porte-aiguilles
- Nadelhalter

- Голкотримачи
- Porta-agujas
- أصحاب إبرة



**Eiselsberg Mathieu**  
33.1477 190mm



**Mathieu**  
33.1478 140mm  
33.1479 170mm  
33.1480 200mm  
33.1481 240mm



**Mathieu**  
33.1482 140mm  
33.1483 170mm



**Boynton**  
33.1484 120mm



**Eiselsberg Mathieu**  
33.1485 190mm



**Mathieu**  
33.1486 140mm  
33.1487 170mm  
33.1488 200mm  
33.1489 240mm



**Mathieu**  
33.1490 140mm  
33.1491 170mm



**Boynton**  
33.1492 120mm



# NEEDLE HOLDERS

- Иглодержатели
- Porte-aiguilles
- Nadelhalter

- Голкотримачи
- Porta-agujas
- أصحاب إبرة

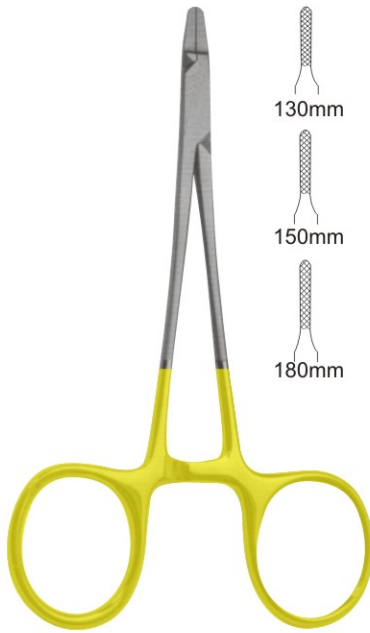

130mm  
150mm  
180mm

**Crile-Ryde**  
33.1493 130mm  
33.1494 150mm  
33.1495 180mm



**Halsey**  
33.1496 130mm



**Baumgartner**  
33.1497 130mm



**Derf**  
33.1498 120mm



**Delicate**  
33.1499 150mm



**Mayo Hegar**  
33.1500 130mm  
33.1501 160mm  
33.1502 180mm  
33.1503 200mm



**Crile Wood**  
33.1504 150mm  
Straight



**Crile Wood**  
33.1505 150mm  
Curved



# NEEDLE HOLDERS

- Иглодержатели
- Porte-aiguilles
- Nadelhalter

- Голкотримачі
- Porta-agujas
- أصحاب إبرة

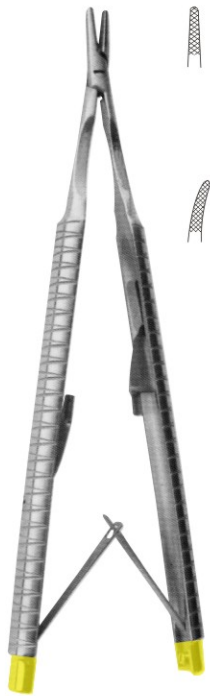

**Castroviejo-Barraquer**  
 33.1506 160mm Straight  
 33.1507 160mm Curved



**Castroviejo**  
 33.1508 140mm  
 33.1509 180mm Straight  
 33.1510 140mm  
 33.1511 180mm Curved



**Castroviejo**  
 33.1512 140mm Angular



**Olsen Hegar**  
 33.1513 140mm  
 Needle Holder  
 with scissors



**Gillies**  
 33.1514 160mm  
 Needle Holder  
 with scissors

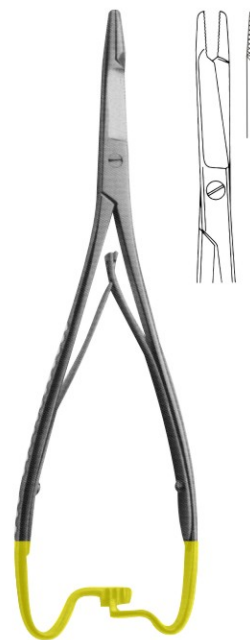

**Mathieu Olsen**  
 33.1515 170mm  
 Needle holder  
 with scissors



# NEEDLE HOLDERS

- Иглодержатели
- Porte-aiguilles
- Nadelhalter

- Голкотримачи
- Porta-agujas
- أصحاب إبرة

For 5-0 to 7-0 Sutures    For 5-0 to 7-0 Sutures



**Castroviejo Scissors**  
33.1516 15cm Str.  
Titanium



**Castroviejo Scissors**  
33.1517 15cm Cvd.  
Titanium



**Castroviejo Needle Holders**  
33.1518 16cm Str.  
Titanium



**Castroviejo Needle Holders**  
33.1519 16cm Cvd.  
Titanium



**Castroviejo Needle Holders T.C**  
33.1520 14cm Str.



**Castroviejo Needle Holders T.C**  
33.1521 14cm Cvd.

For 5-0 to 7-0 Sutures

For 5-0 to 7-0 Sutures

For 5-0 to 7-0 Sutures

For 5-0 to 7-0 Sutures

For 5-0 to 7-0 Sutures



**Castroviejo Needle Holders T.C**  
33.1522 16cm Str.



**Castroviejo Needle Holders T.C**  
33.1523 16cm Cvd.



**Castroviejo Needle Holders T.C**  
33.1524 18cm Str.



**Castroviejo Needle Holders T.C**  
33.1525 18cm Cvd.



**Castroviejo Needle Holders T.C**  
33.1526 14cm fine



# SURGICAL SCISSORS

- Хирургические ножницы
- Chirurgische Schere
- Ciseaux chirurgicaux

- Хирургічні ножиці
- Tijeras quirúrgicas
- مقص جراحي

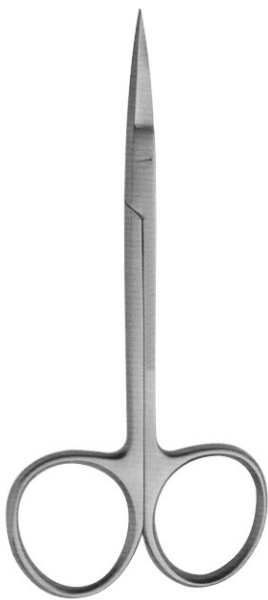

**Iris**  
33.1527 115mm  
Straight

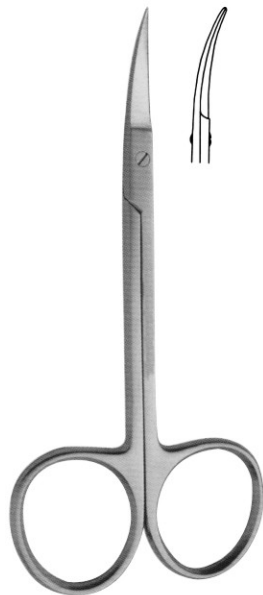

**Iris**  
33.1528 115mm  
Curved

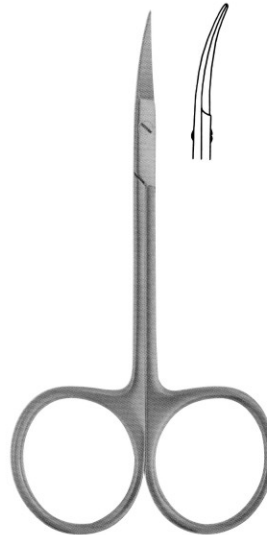

**Micro Iris**  
33.1529 90mm  
Curved

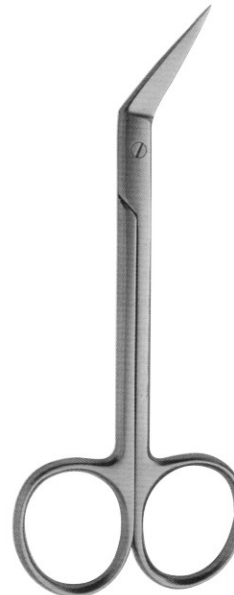

**Iris**  
33.1530 115mm  
Angular



**Iris**  
33.1531 115mm  
Curved

## SURGICAL SCISSORS, SAW EDGE

SAW EDGE

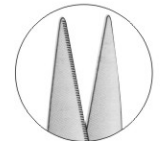

**Goldman-Fox**  
33.1532 130mm  
Saw edge,  
Straight



**Goldman-Fox**  
33.1533 130mm  
Saw edge,  
Curved

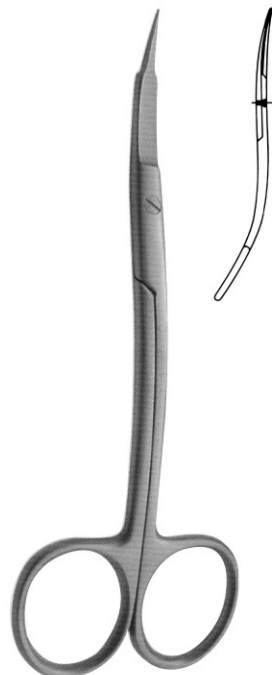

**Goldman-Fox**  
33.1534 130mm  
Saw edge,  
Double Curved

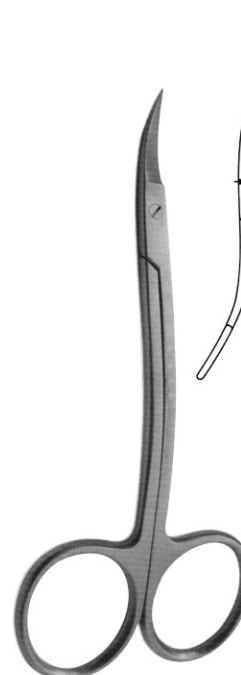

**La Grange**  
33.1535 115mm  
Saw edge,  
Double Curved

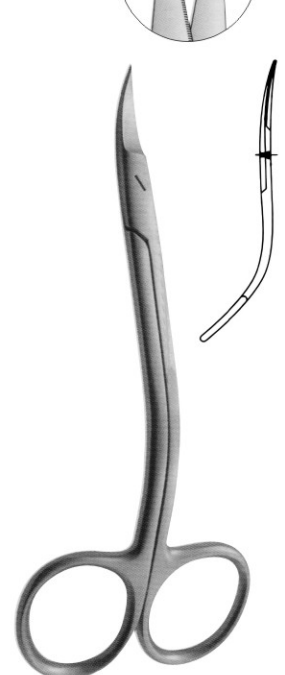

**Neumann**  
33.1536 120mm  
Saw edge,  
Double Curved



- Хирургические ножницы
- Chirurgische Schere
- Ciseaux chirurgicaux

- Хірургічні ножиці
- Tijeras quirúrgicas
- مقص جراحي

### DISSECTING SCISSORS



**Kilner (Ragnell)**  
33.1537 120mm  
Straight

**Kilner (Ragnell)**  
33.1538 120mm  
Curved

**Joseph**  
33.1539 140mm  
Straight

**Joseph**  
33.1540 140mm  
Curved

**Kelly**  
33.1541 160mm  
Straight

**Kelly**  
33.1542 160mm  
Curved

### SUTURE SCISSORS

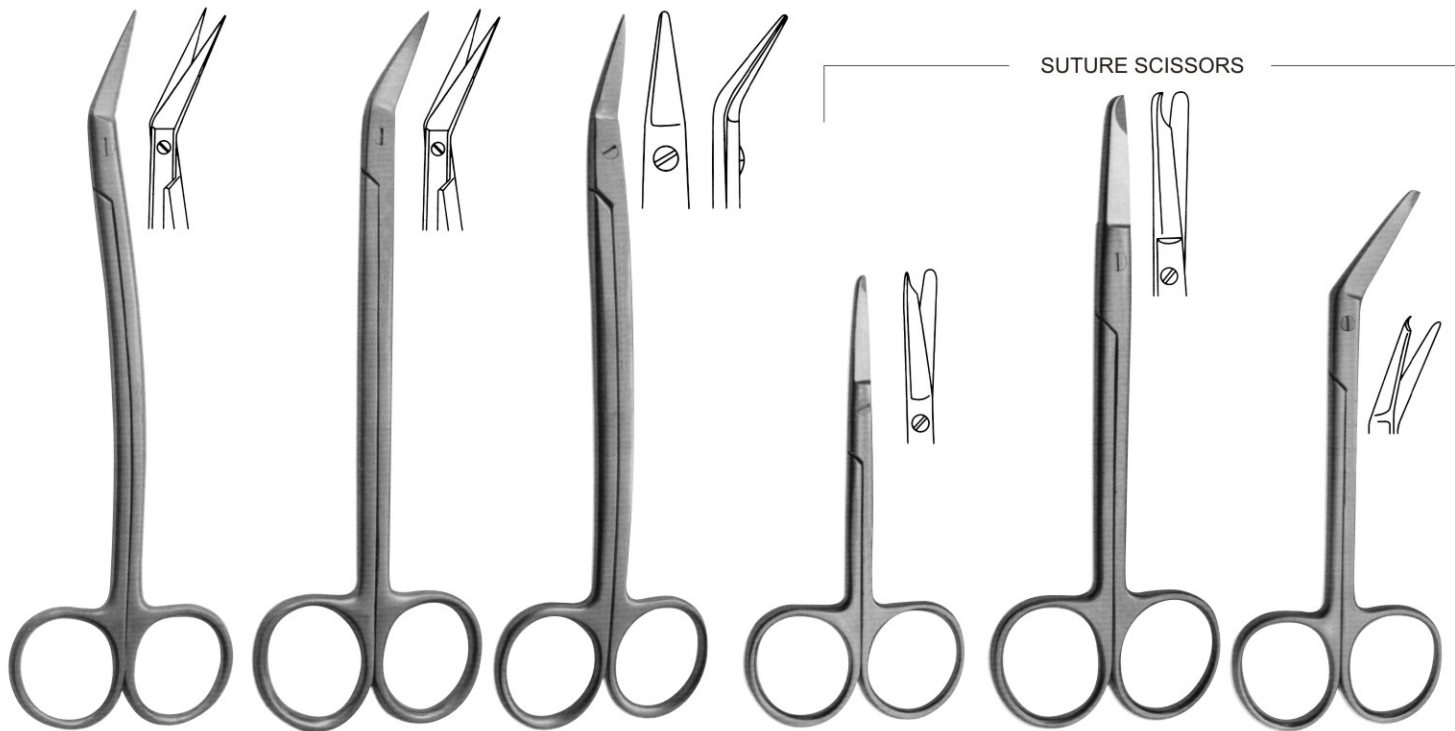

**Locklin**  
33.1543 160mm  
Saw edge  
angular

**Locklin**  
33.1544 160mm  
33.1545 120mm  
Saw edge  
angular

**Dean**  
33.1546 170mm  
Saw edge  
angular

**Spencer**  
33.1547 90mm

**Spencer**  
33.1548 130mm

**Spencer**  
33.1549 115mm



# SURGICAL SCISSORS

- Хирургические ножницы
- Ciseaux chirurgicaux
- Chirurgische Schere

- Хірургічні ножиці
- Tijeras quirúrgicas
- مقص جراحي



33.1550 Straight  
33.1551 Curved  
11.5 cm



Spencer Scissors  
33.1552 Straight  
33.1553 Curved  
11 cm

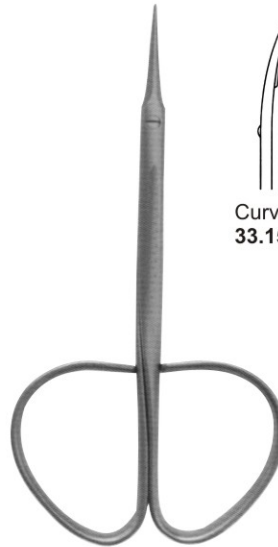

Straight  
33.1554 95mm

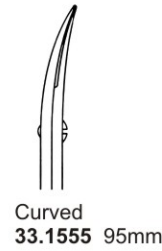

Curved  
33.1555 95mm

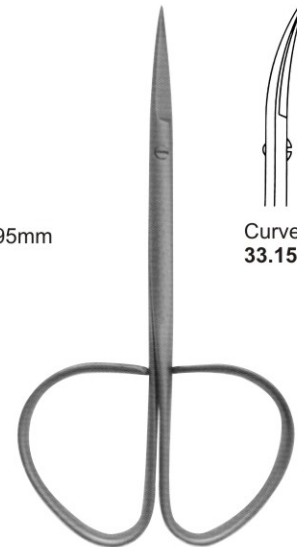

Straight  
33.1556 100mm

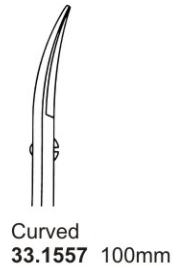

Curved  
33.1557 100mm

## SURGICAL SCISSORS, SQUARE RING

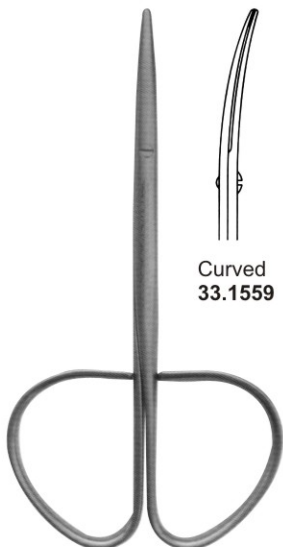

Straight  
33.1558 100mm

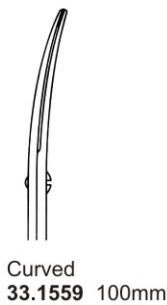

Curved  
33.1559 100mm

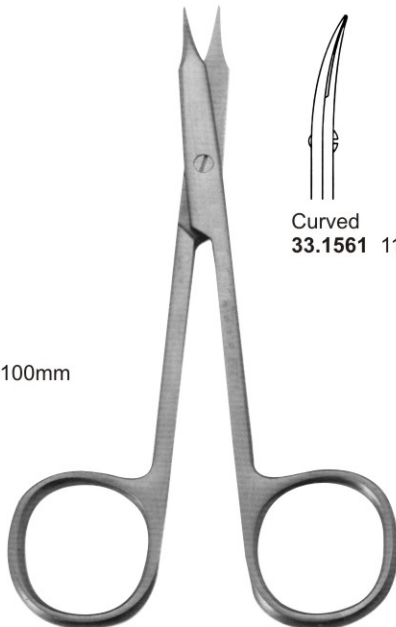

Straight  
33.1560 115mm

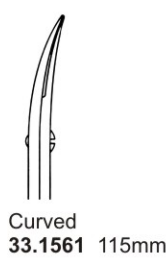

Curved  
33.1561 115mm

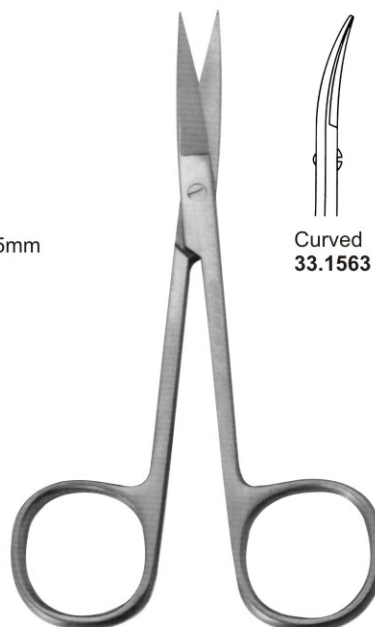

Straight  
33.1562 120mm

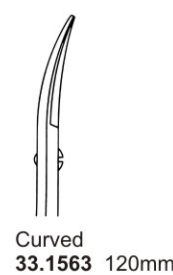

Curved  
33.1563 120mm

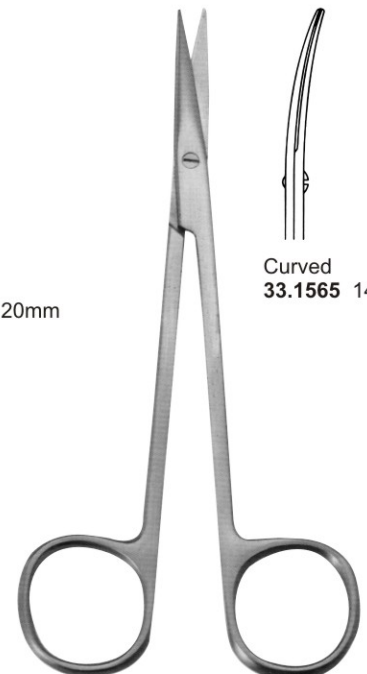

Straight  
33.1564 140mm

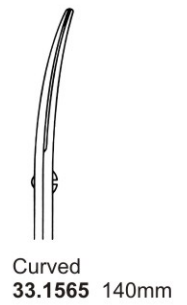

Curved  
33.1565 140mm



# SURGICAL SCISSORS, SPRING ACTION

- Хирургические ножницы, под действием пружины
- Ciseaux chirurgicaux, Printemps action
- Chirurgische Schere, Frühling Aktion

- Хірургічні ножиці, під дією пружини
- Tijeras quirúrgicas, Acción Primavera
- مقص جراحي، الربيع العمل



**Noyes**  
33.1566 110mm  
Straight



**Noyes**  
33.1567 110mm  
Curved



**Noyes**  
33.1568 110mm  
Angular



**Castroviejo**  
33.1569 150mm  
Curved



**33.1570** 155mm  
Straight



**33.1571** 155mm  
Straight



**33.1572** 155mm  
Curved



**33.1573** 150mm  
Straight



**33.1574** 150mm  
Curved



# SURGICAL SCISSORS, CARBIDE INSERTS

- Хирургические ножницы, твердосплавные пластины
- Ciseaux chirurgicaux, Inserts au carbure
- Chirurgische Schere, Schneidplatten

- Хирургічні ножиці, твердосплавні пластини
- Tijeras quirúrgicas, Inserciones de carburo
- مقص جراحی، کربید إدراجات



**Iris**  
33.1575 115mm  
Straight

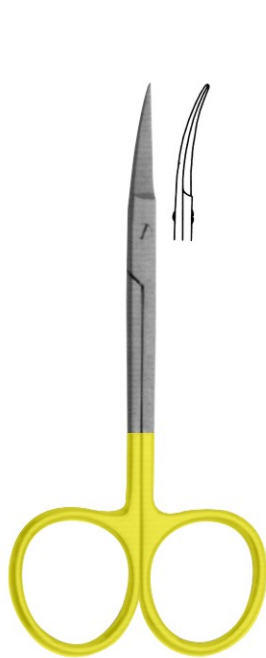

**Iris**  
33.1576 115mm  
Curved



**Goldman Fox**  
33.1577 130mm  
Saw edge,  
Straight



**Goldman Fox**  
33.1578 130mm  
Saw edge,  
curved

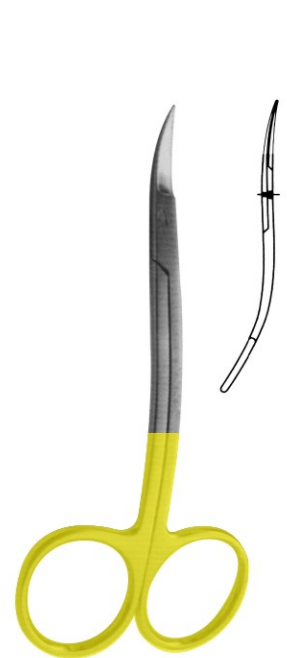

**La Grange**  
33.1579 115mm  
Saw edge,  
Double curved



**Mayo**  
33.1580 140mm  
33.1581 170mm  
33.1582 230mm  
Straight

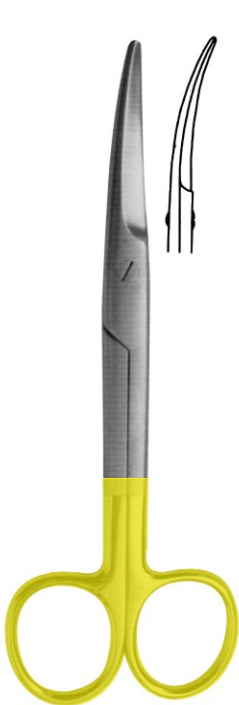

**Mayo**  
33.1583 140mm  
33.1584 170mm  
33.1585 230mm  
Curved

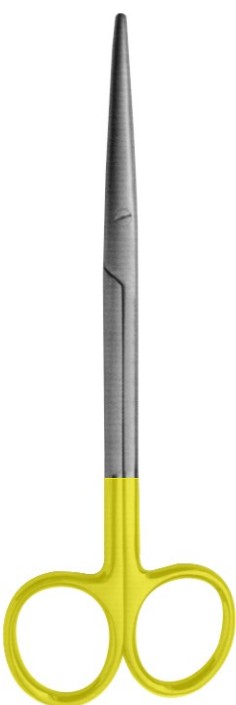

**Metzenbaum**  
33.1586 145mm  
33.1587 180mm  
33.1588 200mm  
Straight

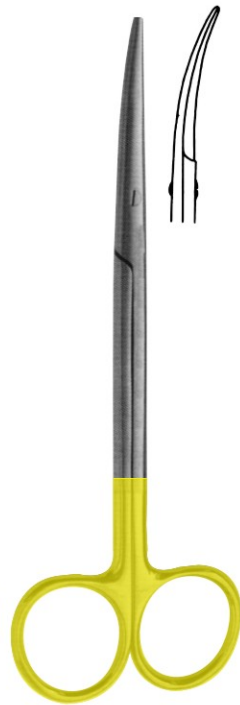

**Metzenbaum**  
33.1589 145mm  
33.1590 180mm  
33.1591 200mm  
Curved

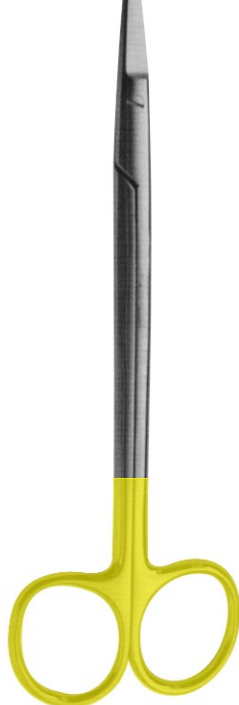

**Kelly**  
33.1592 160mm  
Straight

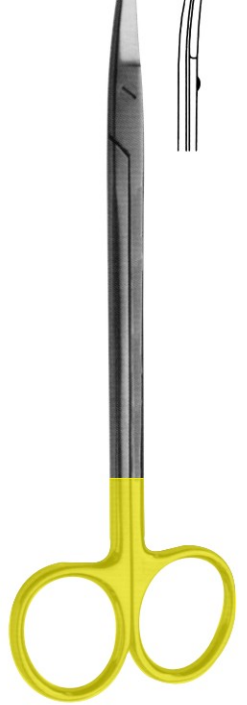

**Kelly**  
33.1593 160mm  
Curved



## SURGICAL SCISSORS, SUPERIOR CUT

- Хирургические ножницы, Улучшенный Cut
- Ciseaux chirurgicaux, Cut Supérieur
- Chirurgische Schere, Superior Cut
- Хірургічні ножиці, Покращений Cut
- Tijeras quirúrgicas, Corte Superior
- مقص جراحي، قص العليا



**Iris**  
33.1594 115mm  
Straight



**Iris**  
33.1595 115mm  
Curved

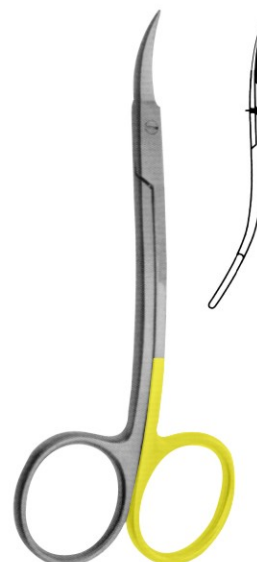

**La Grange**  
33.1596 115mm  
Double  
Curved



**Goldman Fox**  
33.1597 130mm  
Straight



**Goldman Fox**  
33.1598 130mm  
Curved

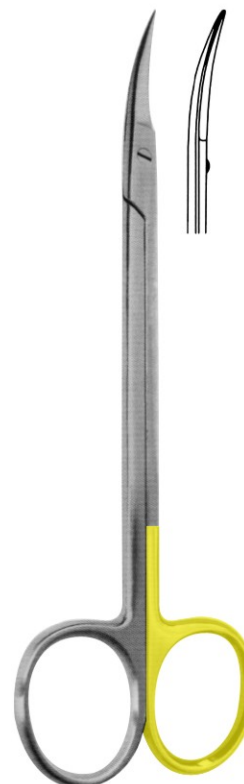

**Kelly**  
33.1599 160mm  
Curved



# SURGICAL SCISSORS

- Хирургические ножницы
- Ciseaux chirurgicaux
- Chirurgische Schere

- Хірургічні ножиці
- Tijeras quirúrgicas
- مقص جراحي

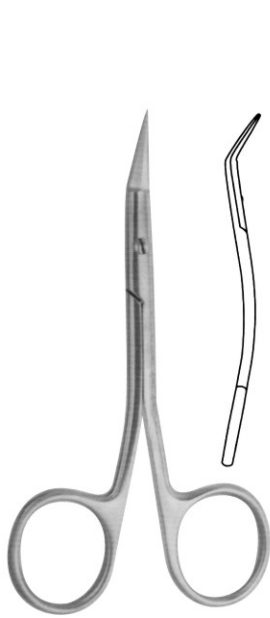

Zed  
33.1600 110mm  
Saw edge

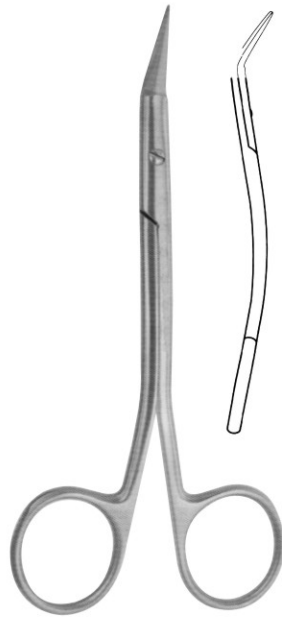

Zed  
33.1601 135mm  
Saw edge

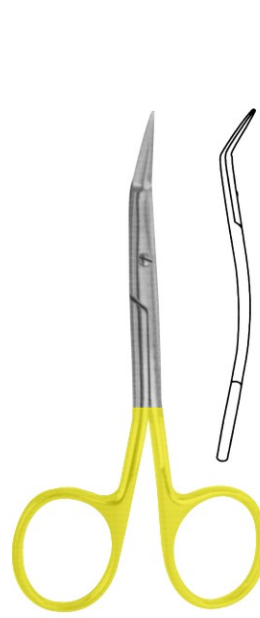

Zed  
33.1602 110mm  
Saw edge

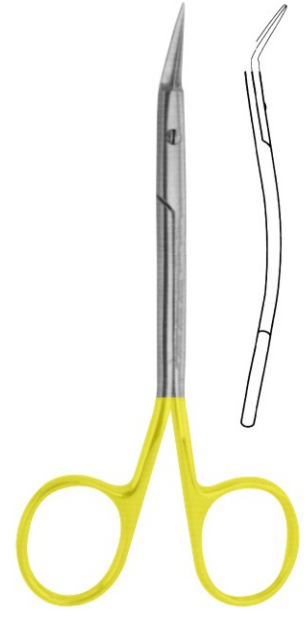

Zed  
33.1603 135mm  
Saw edge

## SURGICAL SCISSORS, TITANIUM

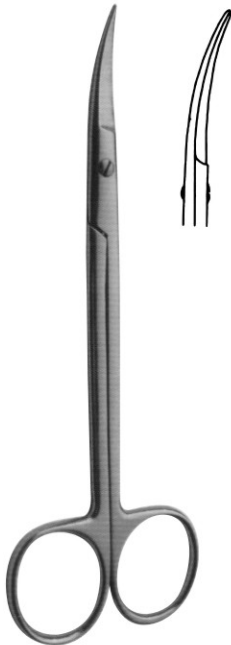

Kelly (Titanium)  
33.1604 160mm  
Curved

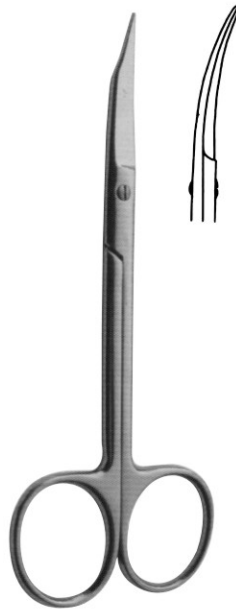

Goldman Fox (Titanium)  
33.1605 130mm  
Curved



(Titanium)  
33.1606 180mm  
Straight



(Titanium)  
33.1607 180mm  
Curved



# UNIVERSAL, CROWN, BANDAGE SCISSORS

- Универсальные, корона, бинты ножницы
- Universal, Couronne, Bandage Ciseaux
- Universal, Crown, Verbandschere
- Універсальні, корона, бинти ножиці
- Universal, Corona, vendaje Tijeras
- العالمي، ولي العهد، ضمادة المقص

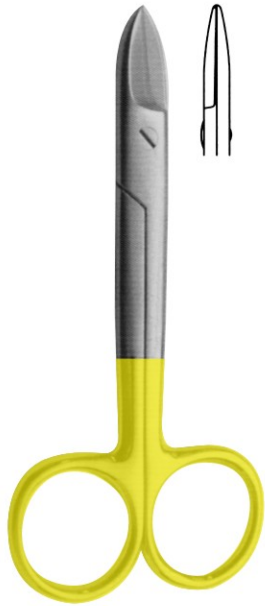

**Beebee**  
33.1608 110mm  
Saw edge,  
Straight

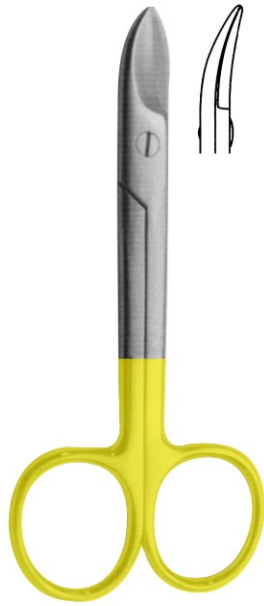

**Beebee**  
33.1609 110mm  
Saw edge,  
Curved



**Beebee**  
33.1610 110mm  
Saw edge,  
Straight



**Beebee**  
33.1611 110mm  
Saw edge,  
Curved



**High Performance**  
33.1612 110mm



**High Performance**  
33.1613 90mm

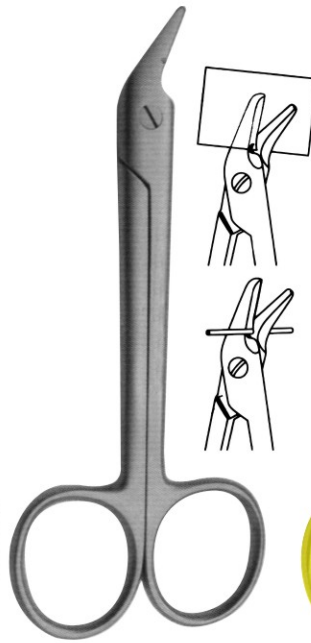

**Universal**  
33.1614 120mm  
Saw edge



**Universal**  
33.1615 120mm



**Bandage Scissors**  
Universal  
Autoclavable  
33.1616  
up to 143° C



# HAEMOSTATIC FORCEPS & TOWEL CLAMPS

- Зажимы артериальные, зажимы для салфеток
- Pincers hemostaticques, Pincers a compresses
- Arterienklemmen, Tuyschklemmen

- Затискачі артеріальні, затискачі для серветок
- Pinzas hemostaticas, Pincers para compresas
- الملقط هایموستاتیک المشابک منشفة



**33.1617**  
Kelly  
14 cm Curved  
Зігнутий



**33.1618**  
Kelly  
14 cm Straight  
Прямий



**33.1619**  
Halstead-Mosquito  
12 cm Straight  
Прямий



**33.1620**  
Halstead-Mosquito  
12 cm Curved  
Зігнутий



**33.1621**  
Micro Masquito  
Fig. 1  
10 cm



**33.1621**  
Straight  
Прямий

**33.1622**  
Curved  
Зігнутий



**33.1623**  
Micro Masquito 1x2  
Fig. 1  
10 cm



**33.1624**  
Curved  
Зігнутий



**33.1625**  
Hartmann  
Fig. 1  
10 cm



**33.1625**  
Straight  
Прямий



**33.1626**  
Curved  
Зігнутий



**33.1627** Fig. 1, 8 cm  
**33.1628** Fig. 2, 11 cm  
**33.1629** Fig. 3, 13 cm  
**33.1630** Fig. 4, 15 cm



**33.1631**  
Schaedel  
09 cm



**33.1632**  
Jones  
09 cm



## DRESSING FORCEPS & TONGUE FORCEPS

- Переодевание щипцы щипцы и язык
- Habiller Pince et Langue Pince
- Kornzangen & Zungenzange
- Перевдягання щипці щипці і мову
- Vestir Pinzas y Lengua Fórceps
- خلع الملابس الملقط والملقط اللسان

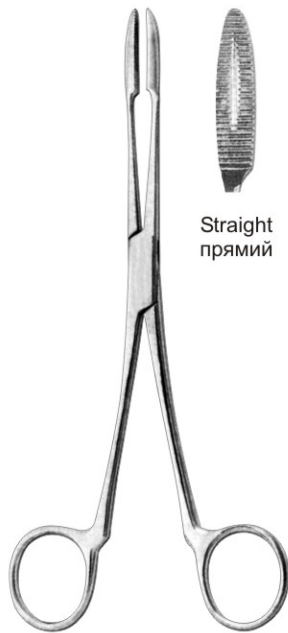

Straight  
прямий

**33.1633**  
Gross-Maier  
20 cm



Curved  
зігнутий

**33.1634**  
Gross-Maier  
20 cm



Straight  
прямий

**33.1635**  
Gross-Maier  
25 cm



Curved  
зігнутий

**33.1636**  
Gross-Maier  
25 cm



**Jacket Grip  
Crown Plier**  
**33.1637** 13.5 cm Str.  
**33.1637A** 13.5 cm Cvd.



**Keramo Grip Plier**  
**33.1638** 14.5 cm Str.  
**33.1638A** 14.5 cm Cvd.



**MAGILL FORCEPS**  
**MAGILL ЩИПЦІ**  
**33.1639**  
Child - Для дітей  
7-1/2", 19cm  
**33.1640**  
Adult - Для дорослих  
9 3/4", 25cm



**YOUNG TONGUE SEIZING FORCEPS**  
**YOUNG ЩИПЦІ ДЛЯ ЗАХОПЛЕННЯ ЯЗИКА**  
**33.1641** With Rubber Jaws, 3 гумовими лещатами  
6-1/4", 16cm  
**33.1642** Replacement Tips, Змінні наконечники 2/set,



- Ранорасширители
- Ecarteurs
- Wundhaken

- Ранорозширювачі
- Separadores
- الكامشات

Lip Retractors  
Розширювач для губ

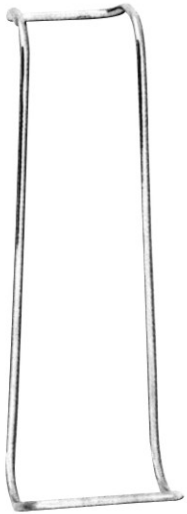

**33.1643**  
Columbia  
14.5 cm



**33.1644**  
Sternberg  
14 cm  
Double Ended  
Двосторонній

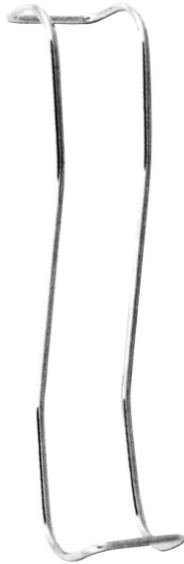

**33.1645**  
Sternberg  
16 cm



**33.1646**  
Sternberg  
14 cm  
Single Ended  
Односторонній



**33.1647**  
Oringer Medium  
Oringer Середній  
11x8 cm

Tongue Depressor



**33.1648**  
14.5 cm



**33.1649**  
14.5 cm



**33.1650**  
Buchwald  
17 cm



**33.1651**  
Brünings  
19 cm



# RETRACTORS - MOUTH GAGS

- Роторасширители
- Ecarteurs - Ouvre-bouches
- Vestibulumabhalter / Mundspanner

- Роторозширювачі
- Separadores - Abre-bocas
- الكامشات-الكمامات الفم



**33.1652**  
Fig. 1  
weitlaner  
10.5cm  
13.5cm



**33.1653**  
Fig. 2  
weitlaner  
10.5cm  
13.5cm



**33.1654**  
Stainless Steel  
Double  
Ended Cheek  
Retractors  
Нержавіюча сталь  
Двосторонні  
розширювачі щік



**33.1655**  
Stainless Steel  
Single  
Ended Cheek  
Retractors  
Нержавіюча сталь  
Односторонні  
розширювачі щік



Weitlander  
**33.1656** 11cm  
**33.1657** 13cm  
**33.1658** 15cm



**33.1662**  
Denhard  
12 cm



**33.1663**  
Roser-König  
16 cm



**33.1664**  
Roser-König  
19 cm



Jennings  
**33.1659** 11cm  
**33.1660** 13cm  
**33.1661** 15cm



## RETRACTORS - MOUTH GAGS

- Роторасширители
- Ecarteurs - Ouvre-bouches
- Vestibulumabhalter / Mundspanner
- Роторозширювачі
- Separadores - Abre-bocas
- الكامشات-الكمامات الفم



**33.1665**  
Mouth Gag Molt  
11 cm for (Children)  
Роторозширювач Molt  
11 см для (Дітей)



**33.1666**  
Mouth Gag Molt  
14 cm for (Adults)  
Роторозширювач Molt  
14 см для (Дорослих)

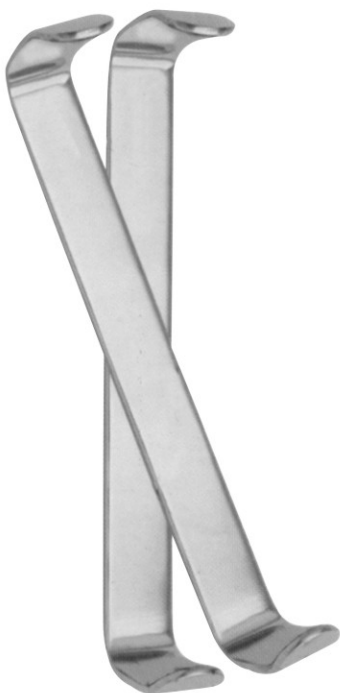

**33.1667**  
Farabeuf  
(120 X 12mm)  
Set of 2 pices)  
Набір з 2 інструментів



**33.1668**  
Minnesota university  
140 mm  
Minnesota university



**33.1669**  
Retractor Seldin  
Ранорозширювач Seldin



**33.1670**  
FELDMAN  
RETRACTOR  
5-1/2", 14cm  
РАНОРОЗШИРЮВАЧ



- Ранорасширители
- Ecarteurs
- Wundhaken

- Ранорозширювачі
- Separadores
- الكامشات



33.1671  
Sharp  
Гострий



33.1672  
Sharp  
Гострий



33.1673  
Blunt  
Тупий



33.1674  
Blunt  
Тупий

16 cm  
Blunt  
Тупий



33.1675  
Sharp  
Гострий



33.1676  
Blunt  
Тупий

16 cm  
Flexible



33.1677  
Sharp  
Гострий



33.1678  
Blunt  
Тупий

Senn-Miller  
16 cm



33.1679

Gilles  
18 cm



33.1680



33.1681

Kilner  
15 cm

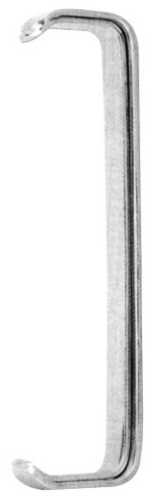

33.1682  
farabeuf  
13 cm



- Ранорасширители
- Ecarteurs
- Wundhaken

- Ранорозширювачі
- Separadores
- الكامشات



33.1683

33.1684

Williger  
13 cm  
Straight, sharp  
Прямий, гострий



33.1685

33.1686

Williger  
13 cm  
Left, sharp  
Наліво, гострий



33.1687

33.1688

Williger  
13 cm  
Right, sharp  
Направо, гострий



33.1689

33.1690

Williger  
13 cm  
Straight, Blunt  
Прямий, гострий

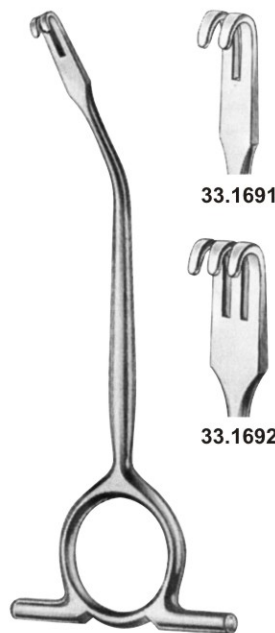

33.1691

33.1692

Williger  
13 cm  
Left, Blunt  
Наліво, гострий



33.1693

33.1694

Williger  
13 cm  
Right, Blunt  
Направо, гострий



- Ранорасширители
- Ecarteurs
- Wundhaken

- Ранорозширювачі
- Separadores
- الكامشات



33.1695  
55x11 mm



33.1697  
55x11 mm

Ramus retractors  
for nasal spine  
Ранорозширювачі  
нижньощелепової гілки  
кістки для носового остюка



33.1699  
33x20 mm  
21 cm

33.1696  
Kocher  
40x11 mm  
21 cm

33.1698  
Kocher  
40x11 mm  
21 cm



33.1700  
35x11 mm  
21 cm

Ramus retractors  
for nasal spine  
Ранорозширювачі  
нижньощелепової  
гілки кістки для  
носового остюка



33.1701  
21.5 mm  
20x14 mm



33.1702  
22 mm  
20x22 mm



33.1703  
23.5 mm  
26x30 mm





- Ранорасширители
- Ecarteurs
- Wundhaken

- Ранорозширювачі
- Separadores
- الكامشات



**33.1704**  
20 mm



**33.1705**  
Langenbeck  
21 cm

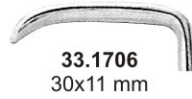

**33.1706**  
30x11 mm

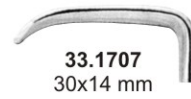

**33.1707**  
30x14 mm

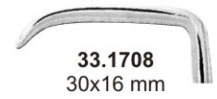

**33.1708**  
30x16 mm

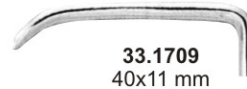

**33.1709**  
40x11 mm

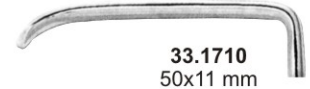

**33.1710**  
50x11 mm



**33.1711**  
Langenbeck  
21 cm

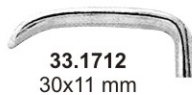

**33.1712**  
30x11 mm

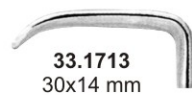

**33.1713**  
30x14 mm

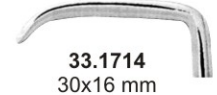

**33.1714**  
30x16 mm

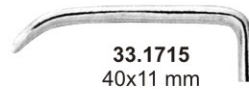

**33.1715**  
40x11 mm

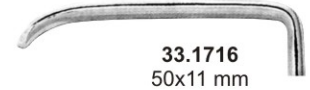

**33.1716**  
50x11 mm



# COPPER RING REMOVING, TELESCOPE CROWN PLIERS

- Медное кольцо Снятие, телескоп Корона Клещи
- Anneau Cuivre Retrait, Télescope Couronne Pinces
- Copper Ring entfernen, Teleskop Crown Zangen
- Мідне кільце Зняття, телескоп Корона Кліщі
- Cobre Anillo Quitar, Telescopio Corona Alicates
- حزام النحاس إزالة، تلسكوب ولي كماشة



33.1717  
Furrer  
16 mm  
Straight  
Прямий



33.1718  
Furrer  
16 mm  
Curved  
Зігнутий



33.1719  
Bohm  
11.5 cm

a 3.3  
b 4  
c 2.3  
d 3.0mm

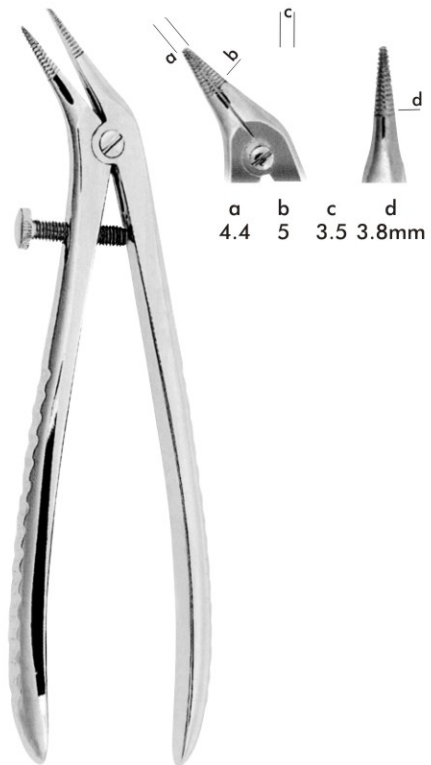

33.1720  
Bohm  
14.5 cm

a 4.4  
b 5  
c 3.5  
d 3.8mm



## CROWN INSTRUMENTS

- Корона инструменти
- Actes de la Couronne
- Krone Instrumente

- корона інструменти
- Instrumentos de la Corona
- الآلات ولي العهد



33.1721  
Fig. Рис. 0  
Universal  
Універсальний



33.1722  
Fig. Рис. 1



33.1723  
Fig.Рис. 2



33.1724  
Crown Spreaders  
Розширювач коронок  
Fig. Рис. 3

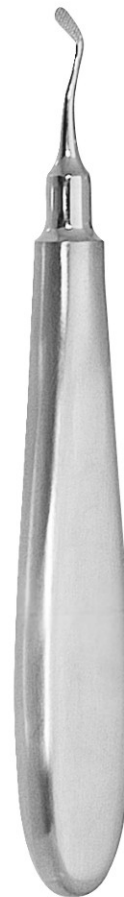

33.1725  
Mershon  
14 cm  
Band Pusher  
Інструмент для просовування  
назубного кільця



## CROWN REMOVERS

- Корона для удале
- Couronne décarants
- Kronenentferner

- корона для видалили
- Corona Removedores
- تاج المزيلات



**A**  
Crown Remover Automatic  
with to Tips  
33.1726



**B**  
Crown Remover Automatic  
with to Tips  
33.1727



**C**  
Crown Remover Automatic  
with to Tips  
33.1728



**D**  
Crown Remover Automatic  
with to Tips  
33.1729



# CROWN REMOVERS

- Корона для удале
- Couronne décarants
- Kronenentferner

- корона для видалили
- Corona Removedores
- تاج المزيلات

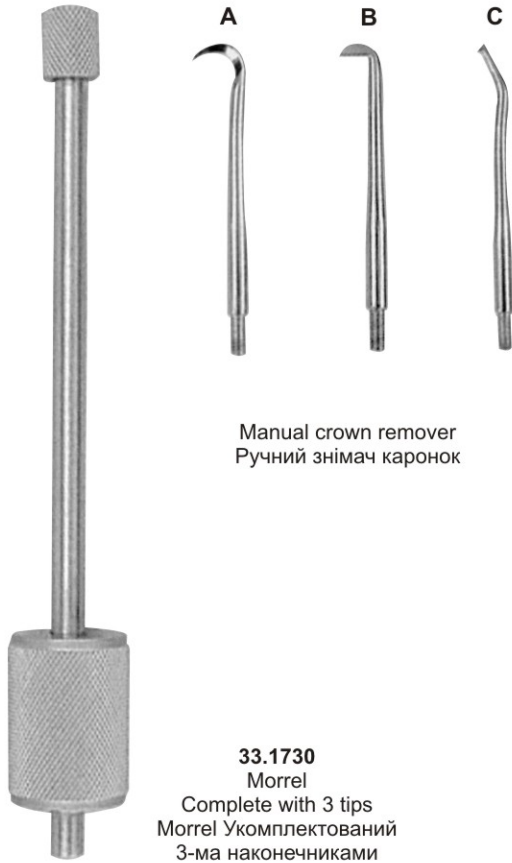

Manual crown remover  
Ручний знімач каронок

**33.1730**  
Morrel  
Complete with 3 tips  
Morrel Укомплектований  
3-ма наконечниками

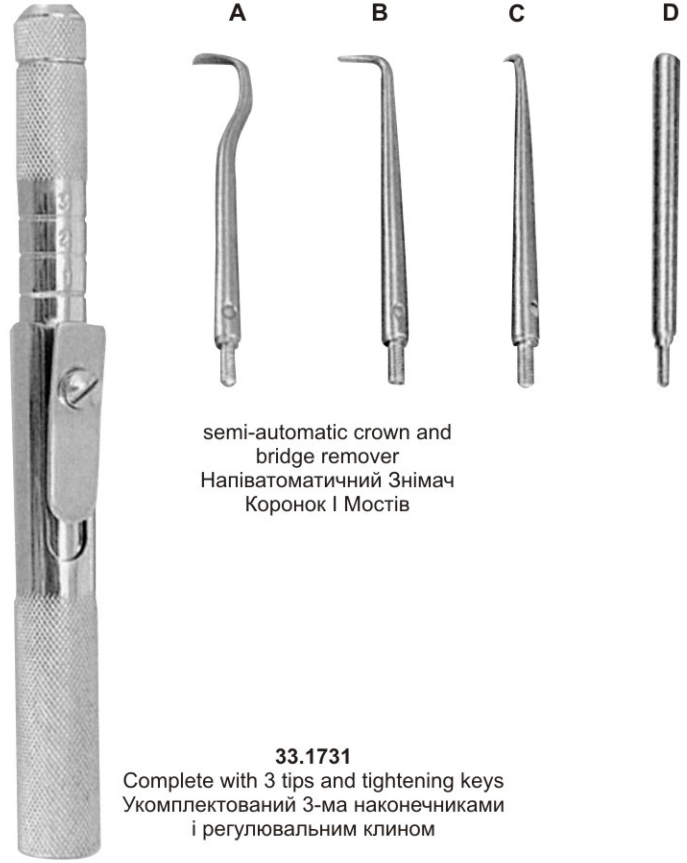

semi-automatic crown and  
bridge remover  
Напівавтоматичний Знімач  
Коронок і Мостів

**33.1731**  
Complete with 3 tips and tightening keys  
Укомплектований 3-ма наконечниками  
і регулювальним клином

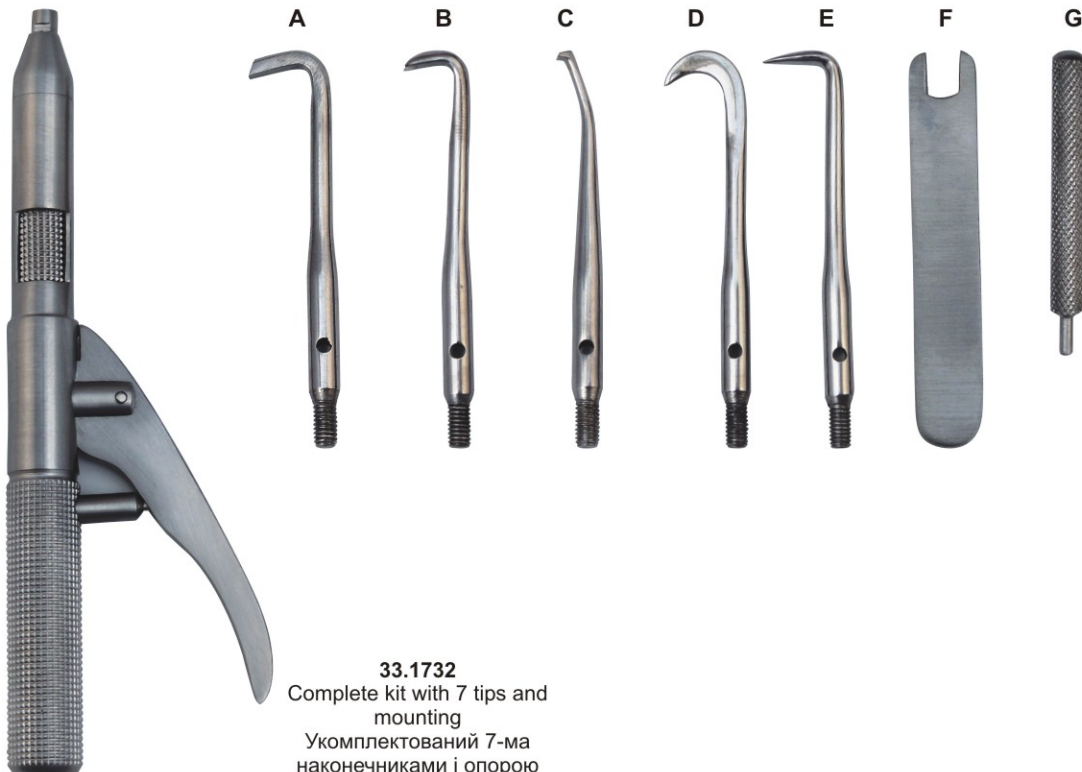

**33.1732**  
Complete kit with 7 tips and  
mounting  
Укомплектований 7-ма  
наконечниками і опорною



## CROWN REMOVERS

- Корона для удале
- Couronne décarants
- Kronenentferner

- корона для видалили
- Corona Removedores
- تاج المزيلات

Crown Removers  
Знімачі коронок

Complete With 3 Attachment  
Укомплектований 3-ма додатками

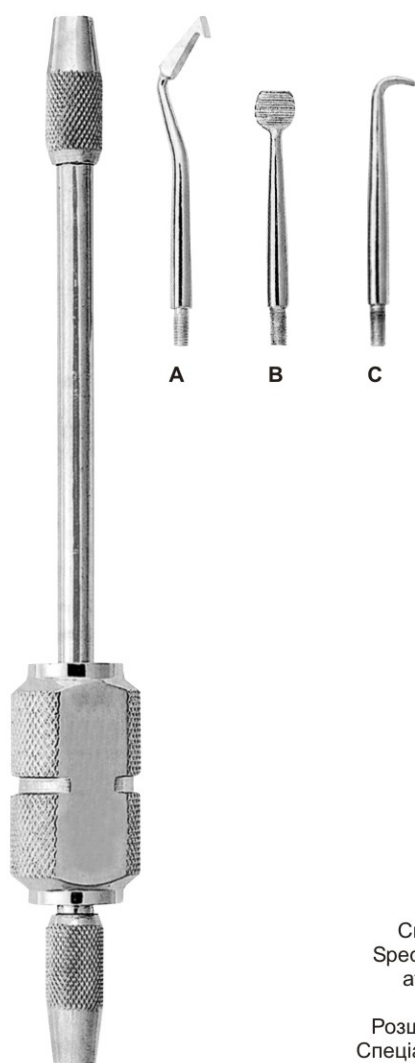

33.1733

Complete With 2 Attachment  
Укомплектований 2-ма додатками



33.1735

Complete With 2 Attachment  
Укомплектований 2-ма додатками



33.1736

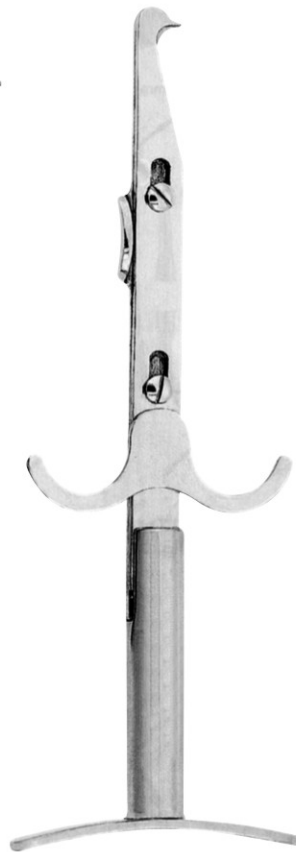

33.1734

Crown Spreader, Crown Remover  
Special Instrument for crown spreading  
after separating, simple and safe  
operation.

Розширювач коронок, Знімач коронок  
Спеціальні інструменти для розширення  
коронок після роз'єднання, звичайна і  
безпечна операція.



## CROWN REMOVERS

- Корона для удале
- Couronne décarants
- Kronenentferner

- корона для видалили
- Corona Removedores
- تاج المزيلات



33.1737

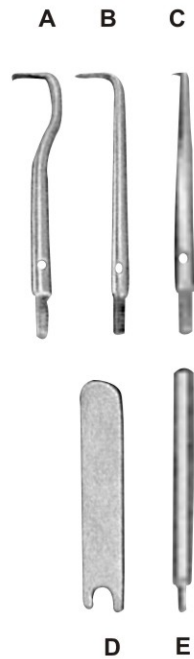

33.1738



33.1739  
Crown Remover  
(Double Ended)  
Знімачі коронок  
Двосторонній)

Fig. Рис. 1 Fig. Рис. 2  
Crown Remover  
Spare Two Points  
Знімачі коронок із двома  
дублікатами наконечників



# CROWN INSTRUMENTS AND PLASTER SHEARS

- Корона інструменти и штукатурка Ножницы
- Actes de la Couronne et cisailles à plâtre
- Krone Instrumente und Gipsschere

- Корона інструменти та штукатурка Ножиці
- Instrumentos de la Corona y tijeras de yeso
- الآلات التاج والمقص الجص



**33.1740**  
Guyer No.7  
Serrated  
Guyer No.7 Зазубрені



**33.1741**  
Guyer No.7  
Plane  
Guyer No.7 Plane



**33.1742**  
Flashing Crown  
Remover  
Знімач коронок  
з тонким покриттям



**33.1743**  
Placement 1  
Інструмент для  
внесення матеріалу 1



**33.1744**  
Calcium Hydroxide  
Placement  
Внесення гідроксиду  
кальцію

st. steel plaster shears



Plastic  
Handle

**33.1745** 17cm  
**33.1746** 20 cm



**33.1747** 17cm  
**33.1748** 20 cm



# RUBBER DAM CLAMP FORCEPS

- Инструменты для системы коффердам
- Pincès porte-crampons a digue
- Kofferdam Klammerzangen

- Инструменти для системи коффердам
- Pinzas de engrapar para dique de caucho
- السد المطاط الملقط المشابك

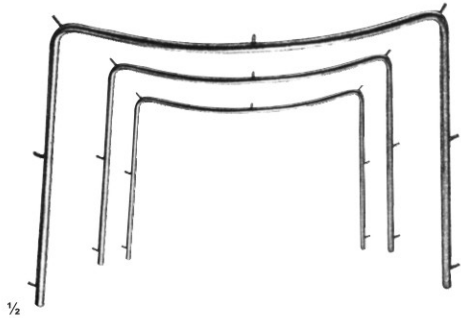

**33.1749**  
Rubber Dam Frame,  
for adults  
Рама раббердаму,  
для дорослих

**33.1750**  
Rubber Dam Frame,  
for Teens  
Рама раббердаму,  
for Teens

**33.1751**  
Rubber Dam Frame,  
for children  
Рама раббердаму,  
для дітей



**33.1752** Rubber Dam Frame,  
for adults

**33.1753** Rubber Dam Frame,  
for Teens

**33.1754** Rubber Dam Frame,  
for children

Complete set of 3 pcs.  
Набір з 3 інструментів



**33.1755**  
Anisworth



**33.1756**  
Anisworth

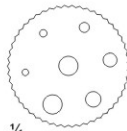

¼

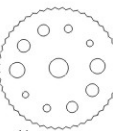
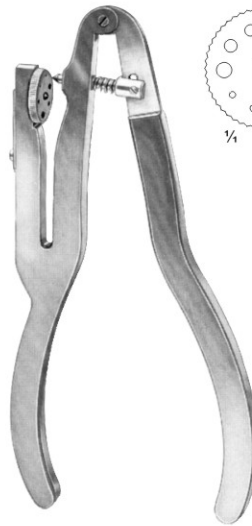

¼

**33.1757**  
Ivory with 1 row of holes  
Для дентину зуба з одним  
рядом дірок

**33.1758**  
Ivory with 2 row of holes  
Для дентину зуба з  
2 рядами дірок

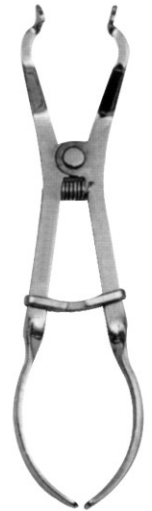

**33.1759**  
Ivory light weight  
Для дентину зуба  
Полегшена конструкція

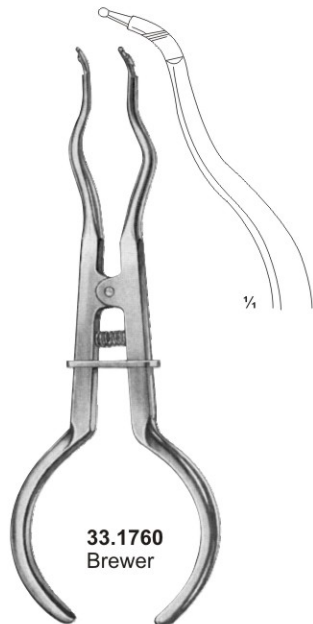

**33.1760**  
Brewer

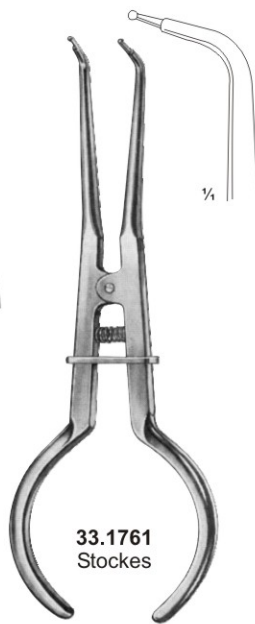

**33.1761**  
Stockes

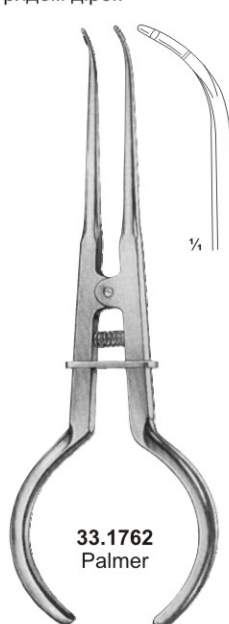

**33.1762**  
Palmer



**33.1763**  
Seaparating  
Elastic  
Plier  
Еластичні  
щипці длі  
здійснення поділу



**33.1764**  
Elastic  
Seaparating  
Plier  
Еластичні  
щипці длі  
здійснення поділу



# AMALGAM INSTRUMENTS

- Инструменты для амальгамы
- Instruments pour amalgame
- Amalgamis\Instrumente

- Инструменти для амальгами
- Instrumentos para amalgama
- الصكوك الملغم



**33.1765**  
Mini/Regular 200mm  
Міні/Середній 200мм

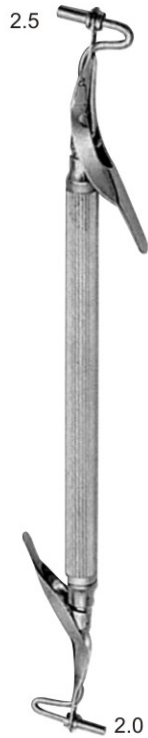

**33.1766**  
Regular/Large 200mm  
Середній /Великий 200мм

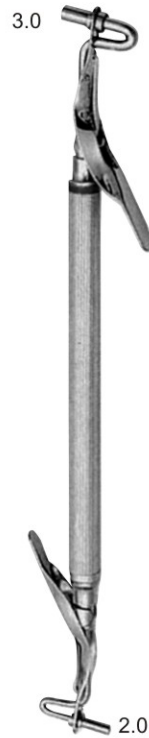

**33.1767**  
Regular/Jumbo 200mm  
Середній /Величезний 200мм

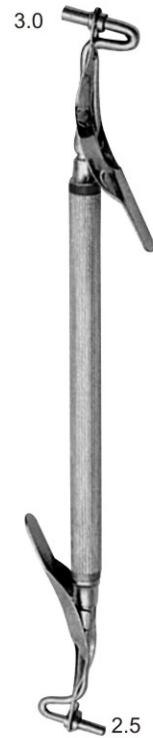

**33.1768**  
Large/Jumbo 200mm  
Великий/Величезний 200мм



**33.1769**  
Jumbo 150mm  
Величезний 150мм

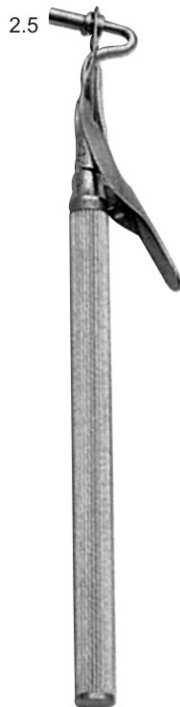

**33.1770**  
Large 150mm  
Великий 150мм

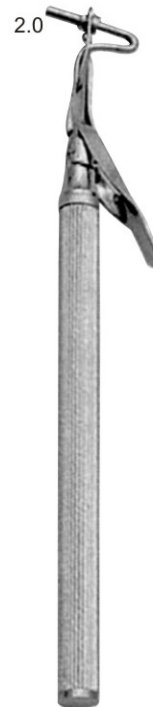

**33.1771**  
Regular 150mm  
Середній 150мм

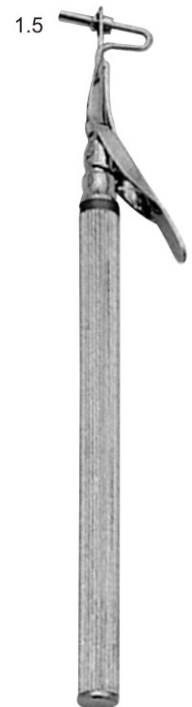

**33.1772**  
Mini 150mm  
Міні 150мм



## AMALGAM INSTRUMENTS

- Инструменты для амальгамы
- Instruments pour amalgame
- Amalgamis\Instrumente

- Инструменти для амальгами
- Instrumentos para amalgama
- الصكوك الملغم

Ø 2mm



**33.1773**  
Fig. Рис. 10  
165mm  
English pattern  
Англійський зразок

Ø 2mm



**33.1774**  
Fig. Рис. 1  
185mm  
German pattern  
Німецький зразок

Ø 2mm



**33.1775**  
Fig. Рис. 1  
150mm  
Swiss pattern  
Швейцарський зразок

Ø 2mm



**33.1776**  
Fig. Рис. 1  
150mm

Ø 2mm



**33.1777**  
Fig. Рис. 2  
150mm, 45°

Ø 2mm



**33.1778**  
Fig. Рис. 3  
140mm, 90°



# AMALGAM INSTRUMENTS

- Инструменты для амальгамы
- Instruments pour amalgame
- Amalgamis\Instrumente

- Инструменти для амальгами
- Instrumentos para amalgama
- الصكوك الملغم

## Cavity Preparation Tips

Наконечники для препарирования кариозной порожни



Type E



33.1779



33.1781  
Half ball left



33.1780  
Half ball straight  
Half ball прямой



33.1782  
Half ball right



33.1783  
Applicator for  
Calcium Hydroxide  
Placer (Single End)  
для Calcium Hydroxide  
Placer (Single End)



33.1784  
Applicator for  
Calcium Hydroxide  
Placer (Double End)  
Applicator для Calcium  
Hydroxide Placer (Double End)



33.1785  
Applicator for  
Calcium Hydroxide  
Placer with mini spatula  
Applicator для Calcium  
Hydroxide Placer with  
mini spatula



33.1786  
Straight  
Прямий  
33.1787  
Curved, Зігнутий  
130mm



33.1788  
Size Small  
AMALGAM WELL  
Stainless Steel  
Амальгамний резервуар  
Нержавіюча сталь



33.1789  
Size Large  
AMALGAM WELL  
Stainless Steel  
Амальгамний резервуар  
Нержавіюча сталь



# MATRIX RETAINERS

- Матрицедержатели
- Porte Matrices
- Matrizenspanner

- Матрицеутримувачи
- Porta Matrices
- مصفوفة الخدم



**33.1790**  
Fig. 5  
Ivory 8  
Дентин зуба 8  
5 mm



**33.1791**  
Fig. 6  
Ivory 8  
Дентин зуба 8  
6 cm



**33.1792**  
Fig. 7  
Ivory 8  
Дентин зуба 8  
7 cm



**33.1793**  
Ivory 8 N  
Дентин зуба 8 N



**33.1794**  
Didner 8 P



**33.1795**  
Fig. 1  
Tofflemire-Universal  
Tofflemire-Універсальний



**33.1796**  
Fig. 2  
Tofflemire-Junior  
Tofflemire-Вторинний



**33.1797**  
Fig. 3  
Tofflemire-Senior  
Tofflemire-Первинний



## MATRIX RETAINERS

- Матрицедержатели
- Porte Matrices
- Matrizenspanner

- Матрицеутримувачи
- Porta Matrices
- مصفوفة الخدم



**33.1798**  
Tofflemire-Junior  
Tofflemire-Вторинний  
45 mm



**33.1799**  
Tofflemire-Universal  
Tofflemire-Універсальний  
60 mm



**33.1800**  
Matrix Ivory 8  
Матриця дентину зуба 8  
6 mm

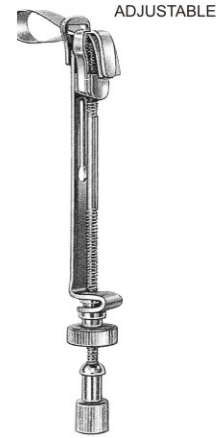

**33.1801**  
Didner 8 P  
70 mm



**33.1802**  
Ivory 12



**33.1803**  
Ivory 1



**33.1804**  
Ivory



**33.1805**  
Elliot



- Инструменты пародонтологические
- Instruments pour la parodontologie
- Instrumente für die Parodontologie
- Інструменти пародонтологічні
- Instrumentos para periodoncia
- الصكوك اللثة

## BONE CHISELS AND GOUGES КІСТКОВІ ДОЛОТА ТА НАПІВКРУГЛІ ДОЛОТА



**33.1806**  
Fig. Рис.1  
Ochsenbein

**33.1807**  
Fig. Рис.2  
Ochsenbein

**33.1808**  
Fig. Рис.1  
Gardner

**33.1809**  
Fig. Рис.2  
Gardner

**33.1810**  
Fig. Рис.5  
Gardner

**33.1811**  
Fig. Рис.5R  
Gardner

**33.1812**  
Fig. Рис.6  
Gardner

**33.1813**  
Fig. Рис. 1W  
Wakefield

**33.1814**  
Fig. Рис. 2W  
Wakefield

**33.1815**  
Fig. Рис. 2W  
Buckley



- Инструменты пародонтологические
- Instruments pour la parodontologie
- Instrumente für die Parodontologie
- Інструменти пародонтологічні
- Instrumentos para periodoncia
- الصكوك اللثة

BONE CHISELS AND GOUGES  
КІСТКОВІ ДОЛОТА ТА НАПІВКРУГЛІ ДОЛОТА



Partsch  
13.5 cm



33.1816  
3mm



33.1817  
4mm



33.1818  
5mm



33.1819  
6mm



Partsch  
13.5 cm



33.1820  
3mm



33.1821  
4mm



33.1822  
5mm



33.1823  
6mm



Partsch  
17 cm



33.1824  
3mm



33.1825  
4mm



33.1826  
5mm



33.1827  
6mm



Partsch  
17 cm



33.1828  
3mm



33.1829  
4mm



33.1830  
5mm



33.1831  
6mm



## PERIODONTAL INSTRUMENTS

- Инструменты пародонтологические
- Instruments pour la parodontologie
- Instrumente für die parodontologie

- Інструменти пародонтологічні
- Intrumentos para periodoncia
- الصكوك اللثة

### Mallets, Молотки



**33.1832**  
SURGICAL MALLET  
ХІРУРГІЧНИЙ МОЛОТОК  
6-1/2", 16.5cm

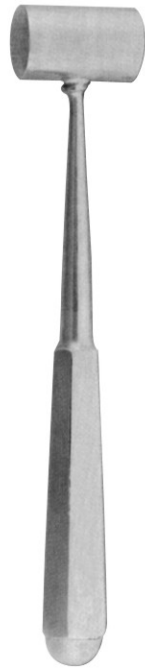

**33.1833**  
Parsch  
19 cm  
Lead filled



**33.1834**  
Mead 19.5 cm  
Non autoclavable  
plastic inserts  
Не підходить для обробки в автоклаві Пластмасові втулки



**33.1835**  
Mead Mallet  
Mead Хірургічний  
МОЛОТОК



**33.1836**  
Molt



**33.1837**  
Mead 17 cm  
Interchangeable  
Ferrozell inserts  
Взаємозамінні втулки Ferrozell



**33.1838**  
Vickers  
19 cm



**33.1839**  
Herbert  
19 cm



- Инструменты пародонтологические
- Instruments pour la parodontologie
- Instrumente für die parodontologie
- Інструменти пародонтологічні
- Instrumentos para periodoncia
- الصكوك اللثة

## PERIOSTEEL ELEVATORS



33.1840  
Beale



33.1841  
Fig. GF  
Goldman-Fox



33.1842  
Fig. M9  
Molt



33.1843  
Fig. M8  
Molt



33.1844  
Fig. M7  
Molt

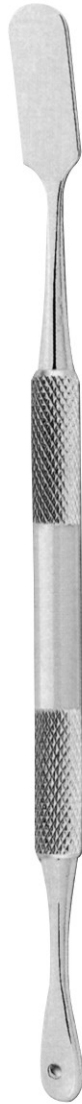

33.1845  
Fig. 9A  
Allen



33.1846  
Fig. 2  
Hourigon



33.1847  
Fig. PR3  
Prichard



33.1848  
Fig. 1  
Hopkins



33.1849  
Fig. 2  
Hopkins



33.1850  
Fig. 3  
Mead



- Инструменты пародонтологические
- Instruments pour la parodontologie
- Instrumente für die Parodontologie
- Інструменти пародонтологічні
- Instrumentos para periodoncia
- الصكوك اللثة

## PERIOSTEEL ELEVATORS



33.1851  
Fig. Рис. 15  
Freer

33.1852  
Fig. Рис. 16  
Freer

33.1853  
Konig  
15.5 cm

33.1854  
Partsch  
14.5 cm

33.1855  
Fig. Рис. 22  
Seldin Retractor

33.1856  
Fig. Рис. 23  
Seldin Retractor

33.1857  
Williger  
17 cm

33.1858  
Williger  
16 cm

33.1859  
Williger  
16 cm

33.1860  
Williger  
13 cm



- Инструменты для костной ткани
- Limes a os
- Knochenfeilen

- Инструменти для кісткової тканини
- Limas para huesos
- ملفات العظام

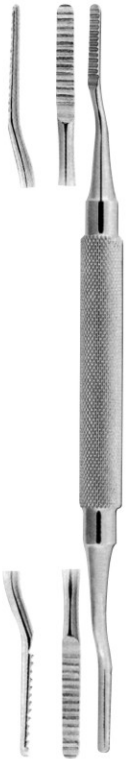

**33.1861**  
Fig. Рис. 1  
PoloKoff

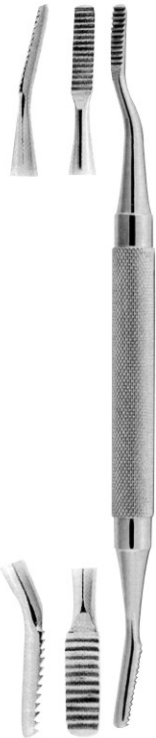

**33.1862**  
Fig. Рис. 33

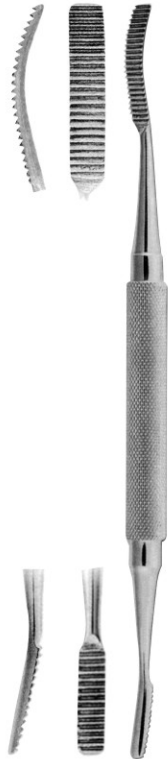

**33.1863**  
Fig. Рис. 45  
Miller



**33.1864**  
Fig. Рис. 64  
Miller

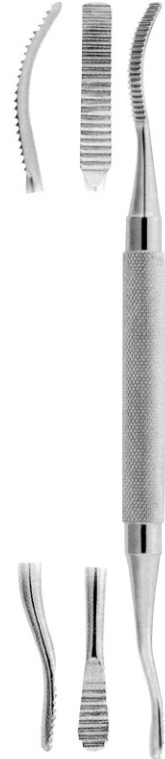

**33.1865**  
Fig. Рис. 10



**33.1866**  
Fig. Рис. 1  
Wahl



**33.1867**  
Fig. Рис. 2  
Wahl

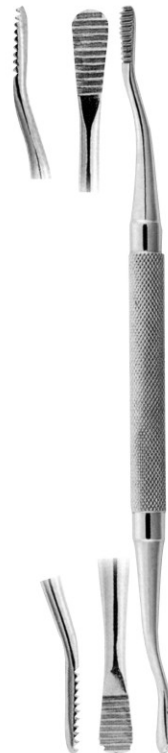

**33.1868**  
Fig. Рис. 12  
Howard

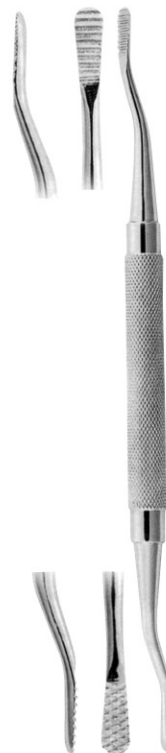

**33.1869**  
Fig. Рис. 12A

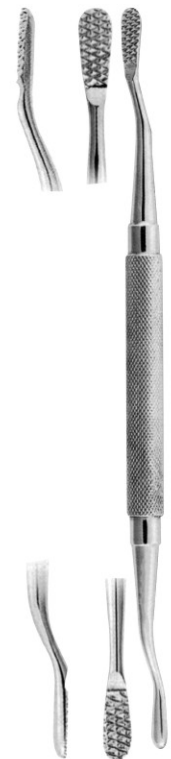

**33.1870**  
Fig. Рис. 12CA



- Инструменты для костной ткани
- Limes a os
- Knochenfeilen

- Инструменти для кісткової тканини
- Limas para huesos
- ملفات العظام

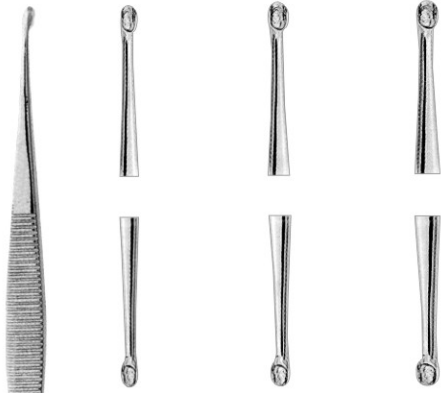

33.1871  
Fig. Рис. 00/0

33.1872  
Fig. Рис. 0/1

33.1873  
Fig. Рис. ½

Williger  
14 cm

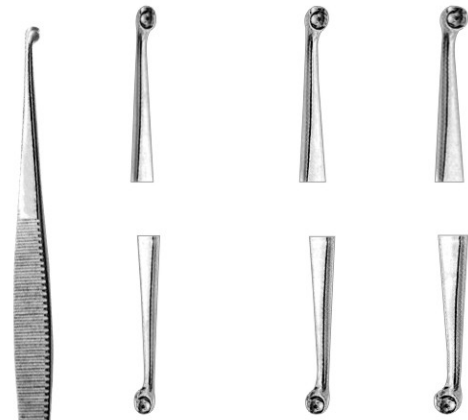

33.1874  
Fig. Рис. 00/0

33.1875  
Fig. Рис. 0/1

33.1876  
Fig. Рис. ½

Martini  
14 cm



33.1877  
Fig. Рис. 1  
16 cm  
USA model  
модель США



33.1878  
Fig. Рис. 1L

33.1879  
Fig. Рис. 1R



33.1880  
Fig. Рис. 2  
16 cm  
USA model  
модель США



33.1881  
Fig. Рис. 2L

33.1882  
Fig. Рис. 2R



- Лабораторное оборудование
- Instruments de laboratoire
- Tasterzirkel / Schiebelehre

- Лабораторне обладнання
- Instrumentos de laboratorio
- قدمه ذات الورنيّة



**33.1883**  
Boley Measuring Range  
Boley Діапазон виміру  
0-100mm, 14 cm

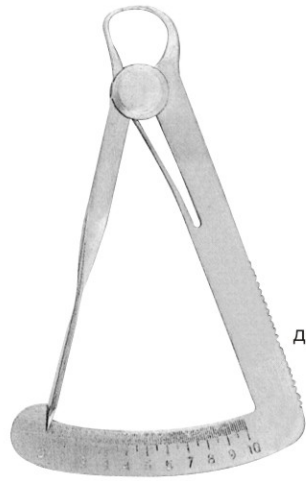

**33.1884**  
Iwanson Measuring Range  
for metal  
Діапазон виміру  
0-10mm  
for metal, для металу



**33.1885**  
Iwanson 100 mm  
decimal spring  
Caliper for wax  
десятковий пружинний  
циркуль для воску



**33.1886**  
Decimal caliper  
Десятковий циркуль  
18cm



**33.1887**  
Crown Pliers  
Гострозубці для коронок  
13 cm

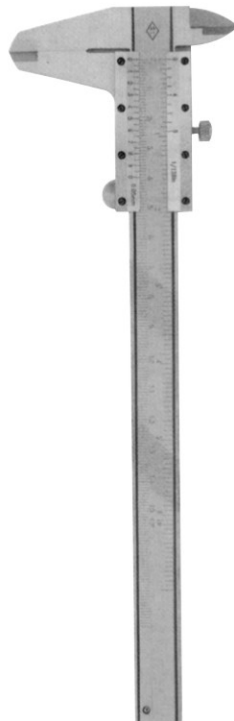

**33.1888**  
Aluminium Caliper  
Алюмінієвий циркуль до  
up to 200mm  
із позначками на  
Graded in 200mm  
& inches  
та в дюймах



**33.1889**  
Townley, Caliper  
graded in mm  
& Inches  
Циркуль із позначками  
в мм та дюймах



**33.1890**  
Jameson, Caliper  
Циркуль



**33.1891**  
Bow, Caliper  
Циркуль



- Лабораторное оборудование
- Instruments de laboratoire
- Tasterzirkel / Schiebelehre

- Лабораторне обладнання
- Instrumentos de laboratorio
- قدمه ذات الورنيّة

**Caliper / Calipers Rule**  
Кронциркуль / Штангенциркуль

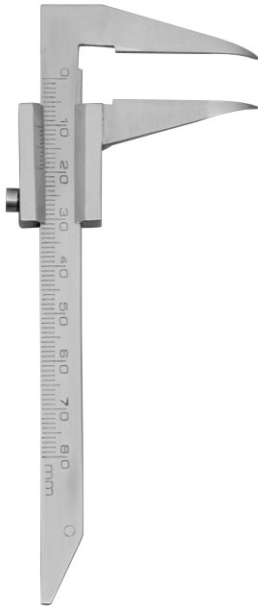

**33.1892**  
Delux Boley  
Gauge  
Ексклюзивний Boley  
Вимірювальний прилад



**33.1893**  
Boley Gauge  
Boley Вимірювальний  
прилад



**33.1894**  
Beerendonk  
130mm  
Mini Gauge  
Вимірювальний  
міні-прилад



**33.1895**  
Bone Bracket Gauge  
Вимірювальний прилад  
для зубних брекетів



**33.1896**  
for .018" slot  
Bracket positioning  
Gauges  
для .018" виїмки для  
укладання брекету  
вимірювальні прилади



**33.1897**  
for .022" slot  
Bracket positioning  
Gauges  
для .022" виїмки для  
укладання брекету  
вимірювальні прилади



**33.1898**  
**OSTEOMETER**  
Measuring Forceps For Jaw Ridge Width  
measurement, scale on both sides,  
rustfree, autoclavable  
**OSTEOMETR**  
Вимірювальний пінцет для вимірювання  
ширини краю щелепи, шкала на обох  
сторонах, стійкий до корозії, підходить  
для обробки в автоклаві



- Лабораторное оборудование
- Instruments de laboratoire
- Tasterzirkel / Schiebelehre

- Лабораторне обладнання
- Instrumentos de laboratorio
- قدمه ذات الورنيّة

Caliper / Calipers Rule  
Кронциркуль / Штангенциркуль



**33.1899**  
CASTROVIEJO CALIPERS  
20mm, 45°  
90mm  
CASTROVIEJO  
КРОНЦИРКУЛЬ  
20мм, 45°, 90мм



**33.1900**  
CASTROVIEJO CALIPERS  
CASTROVIEJO КРОНЦИРКУЛЬ  
20mm  
90mm



**33.1901**  
CASTROVIEJO CALIPERS  
CASTROVIEJO КРОНЦИРКУЛЬ  
20mm  
90mm



**33.1902**  
Ridge Mapping  
Double Caliper  
Подвійний кронциркуль  
для відображення країв



**33.1903**  
Fig. Рис. 5  
Castroviejo  
18cm 7"



**33.1904**  
Fig. Рис. 4  
Castroviejo  
18cm 7"



**33.1905**  
Fig. Рис. 3  
Castroviejo  
18cm 7"



**33.1906**  
Fig. Рис. 2  
Castroviejo  
18cm 7"



**33.1907**  
Fig. Рис. 1  
Castroviejo  
18cm 7"



- Лабораторное оборудование
- Instruments de laboratoire
- Tasterzirkel / Schiebelehre

- Лабораторне обладнання
- Instrumentos de laboratorio
- قدمه ذات الورنيّة



**33.1908**  
MEASURING  
GAUGE  
0-10cm  
Вимірювальний  
Прилад 0-1см



**33.1909**  
MEASURING  
GAUGE  
0-10cm  
Вимірювальний  
Прилад 0-1см



**33.2000**  
Bone Thickness Gauge  
Прилад для вимірювання  
товщини кістки  
40mm  
180mm