

Diagnostics, Periodontal, Restorative & Lab. Instruments

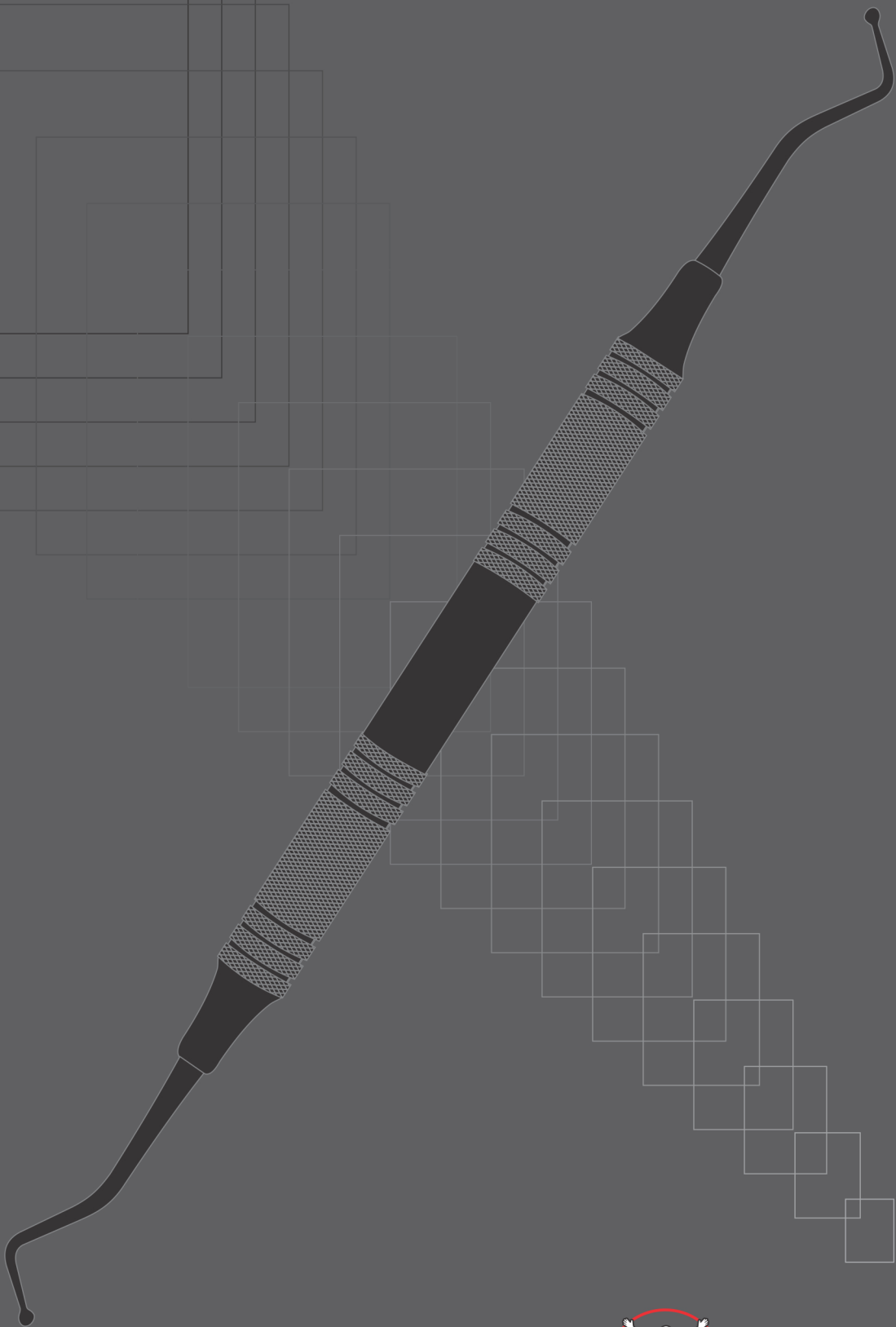

acme surgical®

www.acmesurgical.com



HANDLES FOR MOUTH MIRRORS - MOUTH MIRRORS

- Ручки для зеркал, зеркала стоматологические
- Miroirs à bouche — Manches pour miroirs à bouche
- Mundspiegel Mundspiegelgriffe
- Ручки для дзеркал, дзеркала стоматологічні
- espejos de boca — Mangos para espejos de boca
- مقابض للقم مرایا- مرایا الفم



30.0001
Solid
stainless

30.0004
Hollow
stainless

30.0007
Hollow
stainless

30.0010
Hollow
stainless

30.0013
Hollow
stainless

30.0016
Hollow

30.0019
Hollow

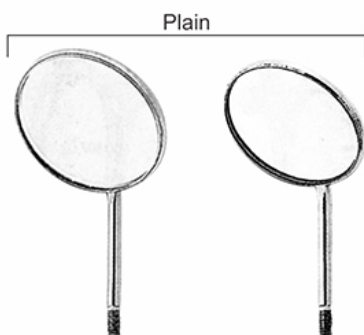

30.0022
Fig. 6
Ø26 mm

30.0025
Fig. 5
Ø24 mm

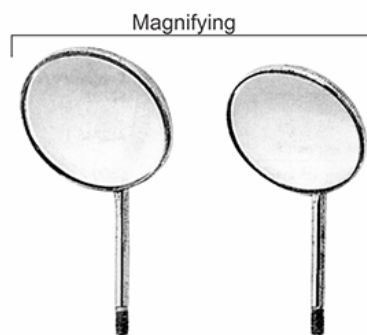

30.0028
Fig. 6
Ø26 mm

30.0031
Fig. 5
Ø24 mm



30.0034
Fig. 4
Ø22 mm

30.0037
Fig. 5
Ø24 mm

HANDLES FOR MOUTH MIRRORS - MOUTH MIRRORS

- Ручки для зеркал, зеркала стоматологические
- Miroirs à bouche — Manches pour miroirs à bouche
- Mundspiegel Mundspiegelgriffe
- Ручки для дзеркал, дзеркала стоматологічні
- espejos de boca — Mangos para espejos de boca
- مقابض للقم مرايا-مرايا الفم

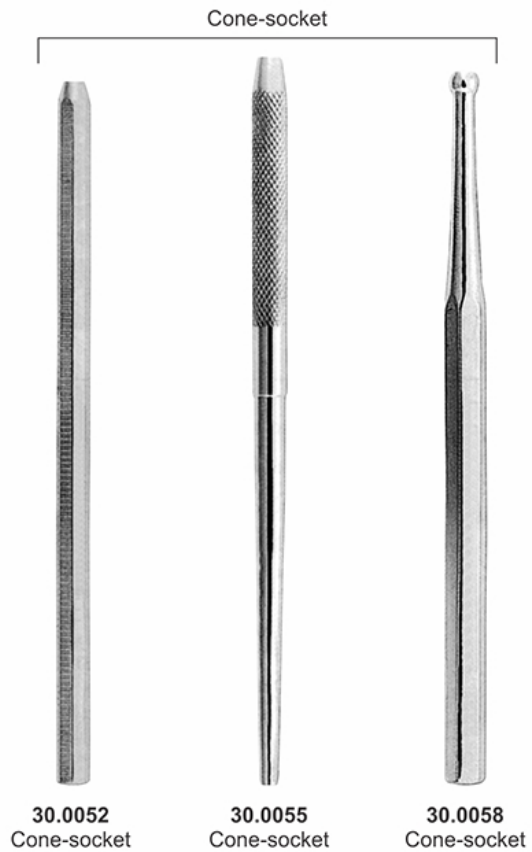
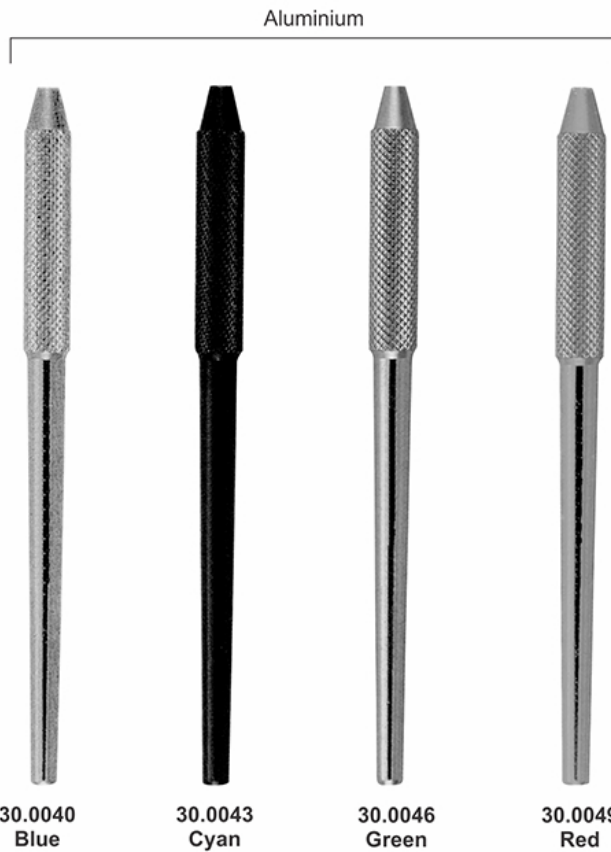



- Пинцеты
- Précettes - Brucelles
- Zahnpinzetten

- Пінцети
- Pinzas para algodón
- ملاقط

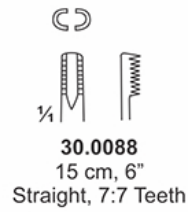
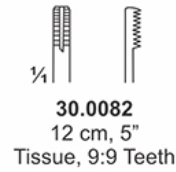

Adson-Brown

Adson-Brown

Brown

Ewald / Hudson

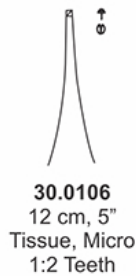
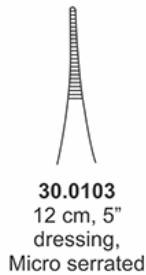
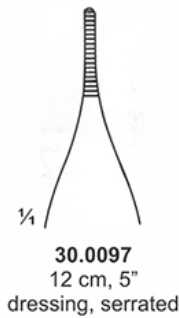
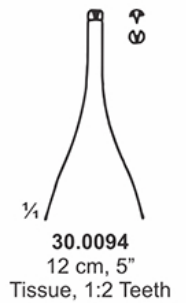

Adson /
Micro-Adson

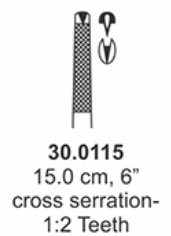
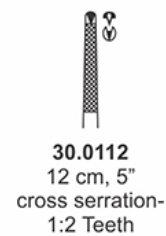
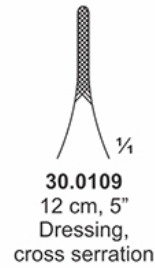

Adson
T.C

TWEEZERS

- Пинцеты
- Précelles - Brucelles
- Zahnpinzetten

- Пінцети
- Pinzas para algodón
- ملاقط

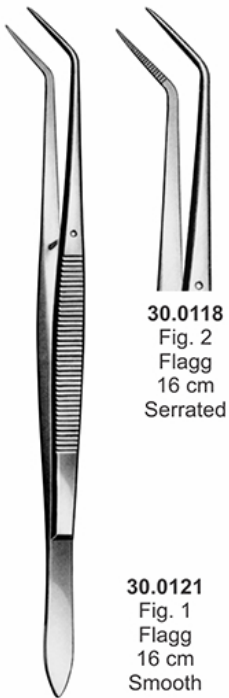

- Пинцеты
- Précelles - Brucelles
- Zahnpinzetten

- Пінцети
- Pinzas para algodón
- ملاقط



30.0146
Fig. 1
Meriam
16 cm
Smooth



30.0149
Fig. 2
Meriam
16 cm
Serrated



30.0152
Fig. 1
Meriam
16 cm
Smooth



30.0155
Fig. 2
Meriam
16 cm
Serrated



30.0158
Meriam
Toe Joint
16 cm
Smooth



30.0161
Meriam
15 cm
Smooth



30.0164
Fig. 1
Crane Kaplan
15 cm



30.00167
Fig. 2
Crane Kaplan
15 cm



30.0170
Hemingway
17 cm

TWEEZERS

- Пинцеты
- Prècelles - Brucelles
- Zahnpinzetten

- Пінцети
- Pinzas para algodón
- ملاقط

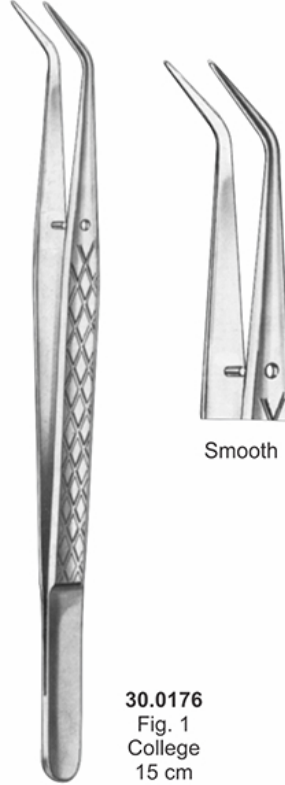
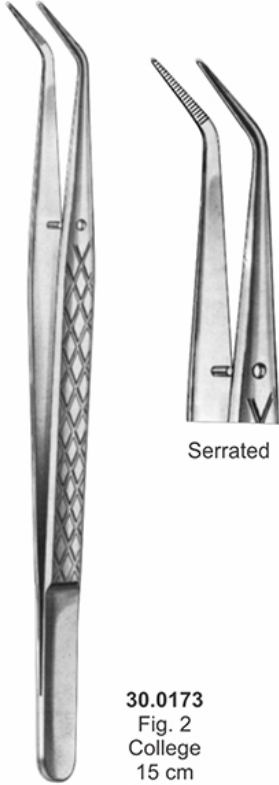



- Пинцеты
- Précelles - Brucelles
- Zahnpinzetten

- Пінцети
- Pinzas para algodón
- ملاقط



30.0194
Fig. 1
Perry
13 cm



30.0197
Perry
10.5 cm



30.0200
Perry
10.5 cm



30.0203
Perry
13 cm



30.0206
Perry
13 cm



30.0209
Perry
13 cm



30.0212
Fig. 1
15 cm
Smooth



30.0215
Fig. 2
15 cm
Serrated

TWEEZERS

- Пинцеты
- Précelles - Brucelles
- Zahnpinzetten

- Пінцети
- Pinzas para algodón
- ملاقط



30.0216
Fig. 1
Atraumatic
15 cm



30.0224
Fig. 1
Atraumatic
15 cm



30.0218
Fig. 1
Guttaperca
self-locking
15 cm



30.0227
Fig. 1
Gerald
17.5 cm



30.0221
Fig. 2
Guttaperca
self-locking
15 cm



30.0230
Fig. 1
Atraumatic
20 cm



- Пинцеты
- Précelles - Brucelles
- Zahnpinzetten

- Пінцети
- Pinzas para algodón
- ملاقط



30.0233
15 cm
Fig. 1
Thin Pattern



30.0236
15 cm
Fig. 2
Wide Pattern



30.0239
14 cm



30.0242
15 cm
Fig. 1



30.0245
15 cm
Fig. 2



30.0248
16.5 cm
Fig. 1

Micro Surgery Instrument



30.0251
18 cm
Fig. 1



30.0254
18 cm
Fig. 2



30.0257
18 cm
Fig. 3



30.0260
18 cm
Fig. 4

SOLDERING PLIERS - TWEEZERS & SPLINTER FORCEPS

- Пинцеты для удаления осколков
- Pincas à souder - Pincas et pincas à échardes
- Löt-Zange - Pinzette & SplinterZange

- Пінцети для видалення осколків
- Alicates Soldadura - Pinzas y pinzas de Splinter
- لحام كماشة - ملاقط منشقة الملقط



30.0263
12.5 cm



30.0266
12.5 cm



30.0269
12.5 cm



30.0272
12.5 cm



30.0275
12.5 cm



30.0278
12.5 cm



30.0281
12.5 cm



30.0284
11.1 cm



SOLDERING PLIERS - TWEEZERS & SPLINTER FORCEPS

- Пинцеты для удаления осколков
- Pincés à souder - Pincés et pincés à écharde
- Löt-Zange - Pinzette & SplinterZange

- Пінцети для видалення осколків
- Alicates Soldadura - Pinzas y pinzas de Splinter
- لحم كماشة - ملاقط منشقة الملقط



30.0287
16 cm



30.0290
16 cm



30.0293
Posigrip Articulating
Paper Forceps
15 cm



30.0296
Standard Articulating
Paper Forceps, Economy Grade
15 cm

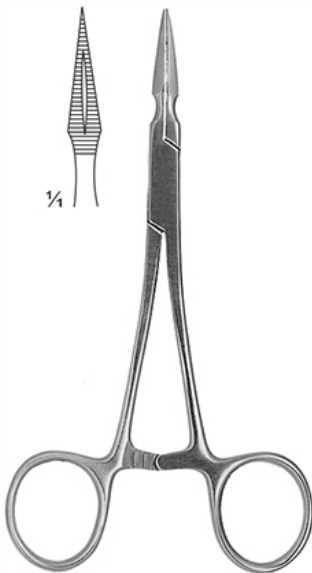

Stieglitz
30.0298
14 cm, 5 1/2" Str.

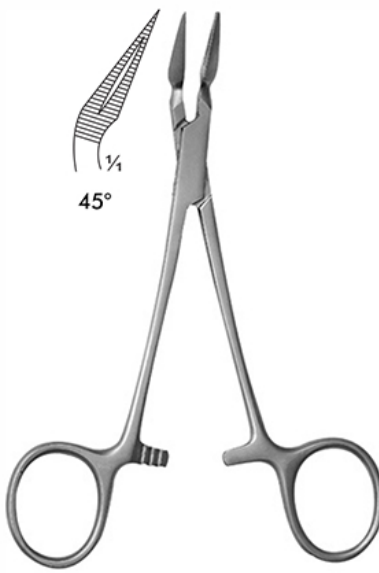

30.0302
14 cm, 5 1/2" 45°

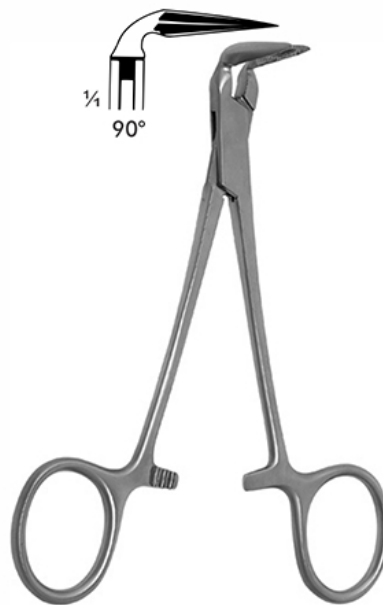

30.0305
14 cm, 5 1/2" 90°

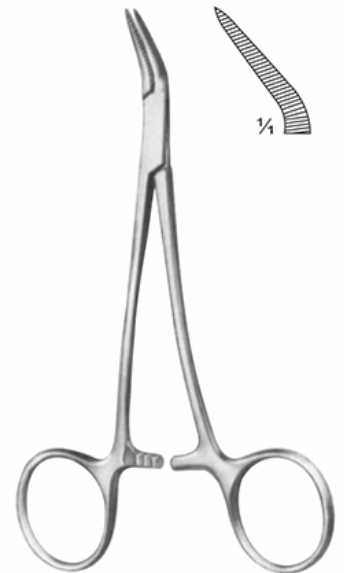

Peet
30.0308
11.5 cm, 4 1/2"

EXPLORERS

- Зонды
- Sondes
- Zahnsonden

- Зонди
- Sondas
- المسنكشفين

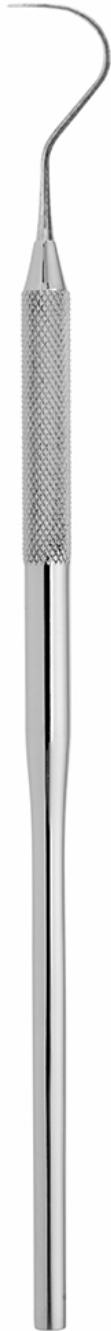

30.0311
Fig. 23



30.0314
Fig. 2



30.0317
Fig. 16



30.0320
Fig. 9



30.0323
Fig. 10



30.0326
Fig. 12



30.0328
Fig. 11



30.0331
Fig. 6



30.0334
Fig. 8



30.0337
Fig. 5



30.0340
Fig. 17



30.0343
Fig. 17A



30.0344
Fig. 3



30.0346
Fig. 3A



30.0348
Fig. 3R

- Зонды пародонтологические
- Sondes paradontales
- sonde parodontali

- зонди пародонтологічні
- Sondas paradontales
- المسابر اللثة

Periodontal pocket probe with two different tips: one cone shaped end (Williams), one flat end (Goldman-Fox)



Periodontal pocket probe n.2 with a curved tip for easier access to forked areas

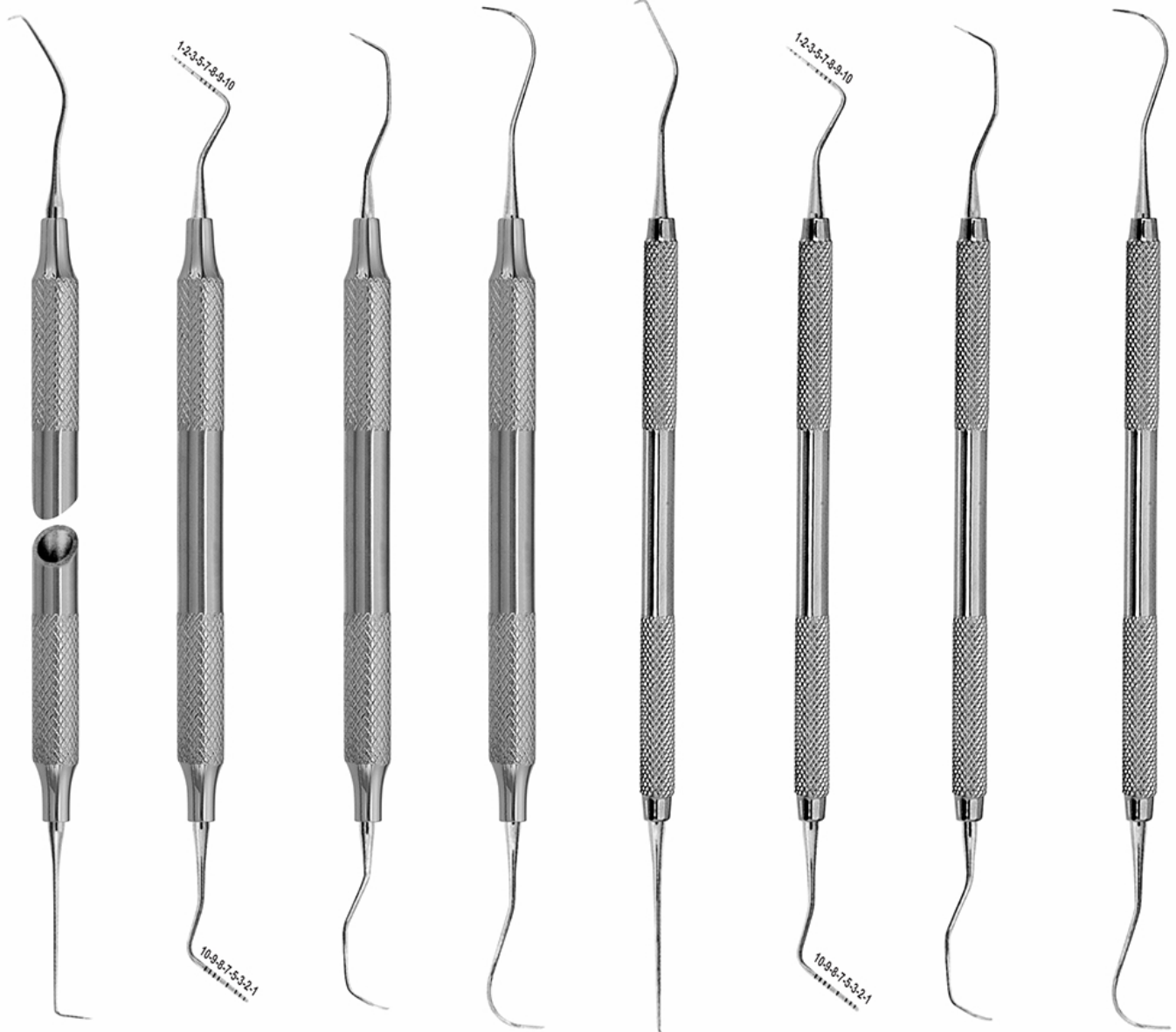

30.0351
Fig. 1/2
Cattoni

30.0354
Goldman-Fox
Williams

30.0357
Fig. 1N
Nabers

30.0360
Fig. 2N
Nabers

30.0363
Fig. 1/2
Cattoni

30.0366
Goldman-Fox
Williams

30.0369
Fig. 1N
Nabers

30.0372
Fig. 2N
Nabers

EXPLORERS

- Зонды
- Sondes
- Zahnsonden
- Зонди
- Sondas
- المسنكشفين



30.0375
Fig. UT 1/2
Cattoni



30.0378
Fig. 11/12AF



30.0381
Fig. 23/17



30.0384
Fig. 23/17A

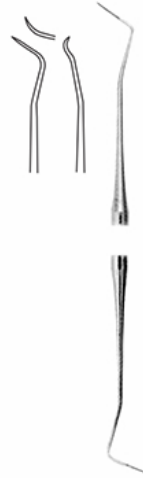

30.0385
Fig. 2

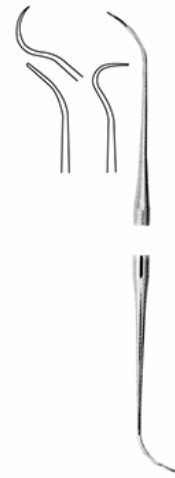

30.0386
Fig. 2A



30.0389
Fig. 3



30.0392
Fig. 16/23



30.0395
Fig. 16/3



30.0398
Fig. 6/9



30.0401
Fig. 6/1



30.0404
Fig. 6/17



30.0407
Fig. 6/23



- Зонды
- Sondes
- Zahnsonden

- Зонди
- Sondas
- المسنكشفين

Canal or Endodontic Explorer



30.0413
Fig. 23/17



30.0416
Fig. 23/17A



30.0419
Fig. 2



30.0422
Fig. 2A



30.0425
Fig. 3



Root Canal Explorers



30.0410
Fig. 1/2
Cattoni



30.0428
Fig. 16/23



30.0431
Fig. 16/3



30.0434
Fig. 6/1



30.0437
Fig. 6/17



30.0440
Fig. 6/23

PERIODONTAL PROBES

- Зонды пародонтологические
- Sondes parodontales
- sonda parodontali
- зонди пародонтологічні
- Sondas parodontales
- المسابر اللثة

Williams Periodontal Pocket Probe

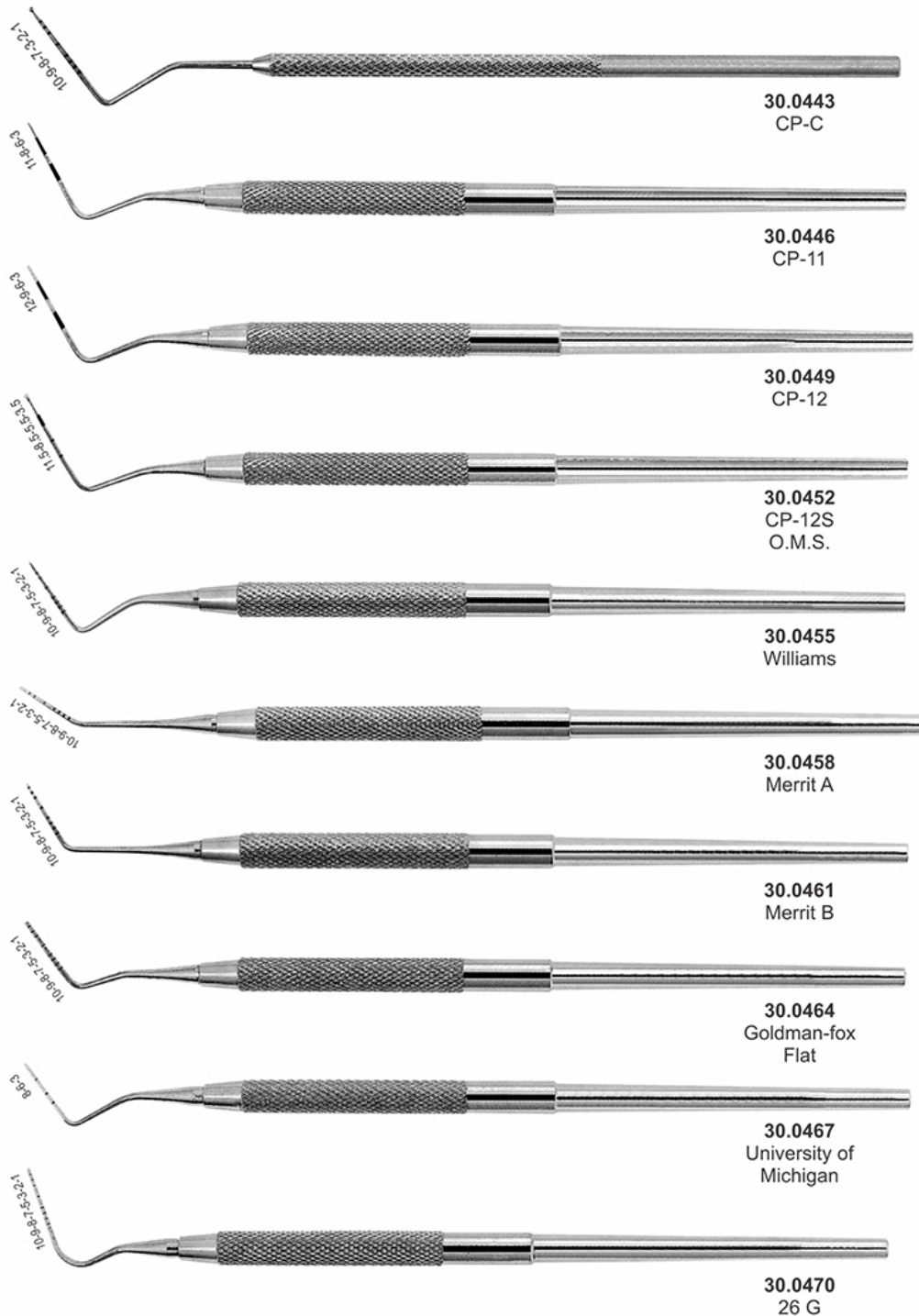

- Зонды пародонтологические
- Sondes paradontales
- sonde parodontali

- зонди пародонтологічні
- Sondas paradontales
- المسابر اللثة

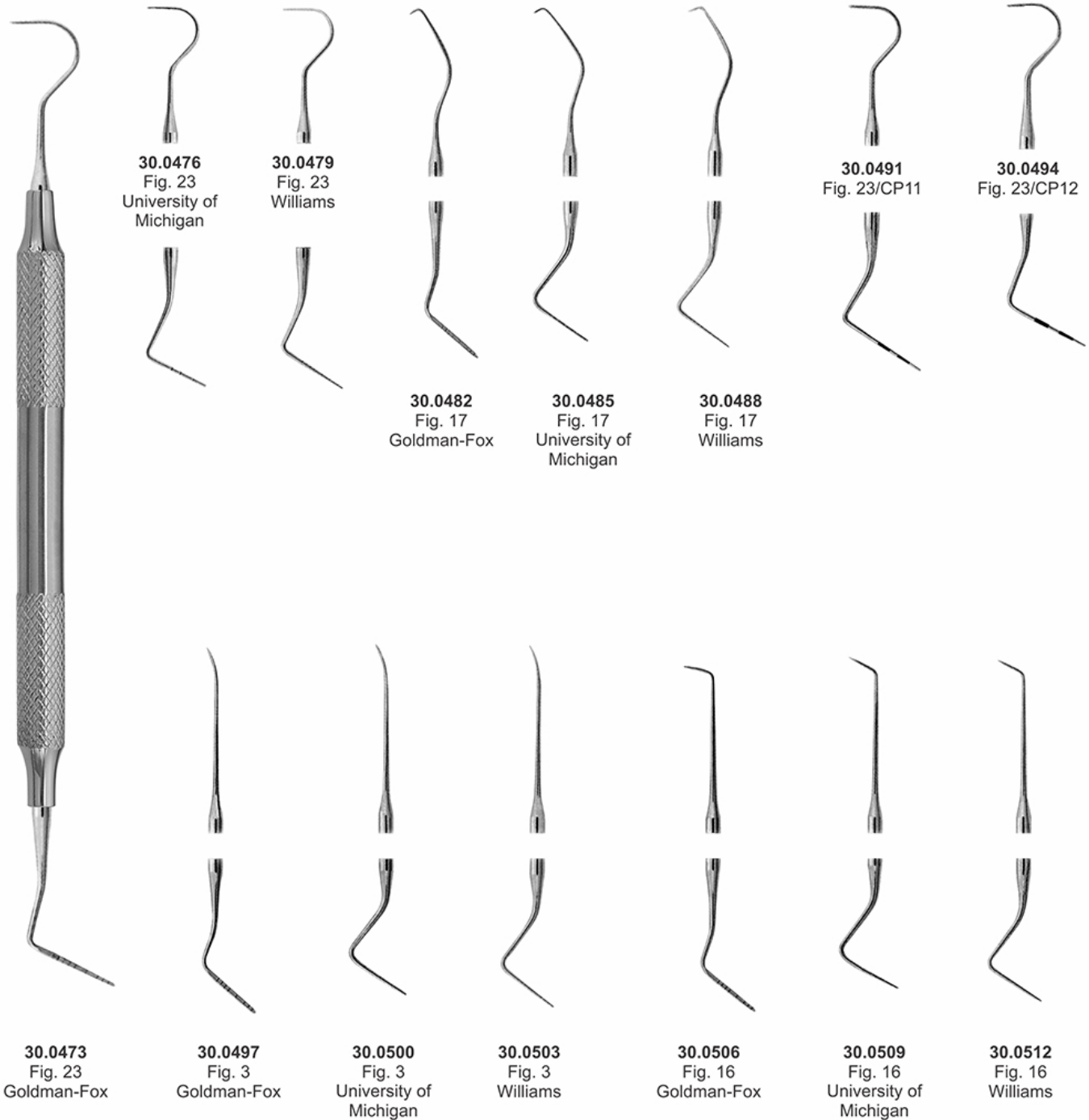

PERIODONTAL PROBES

- Зонды пародонтологические
- Sondes parodontales
- sonda parodontali
- зонди пародонтологічні
- Sondas parodontales
- المسابر اللثة

Spreader For Lateral Condensation

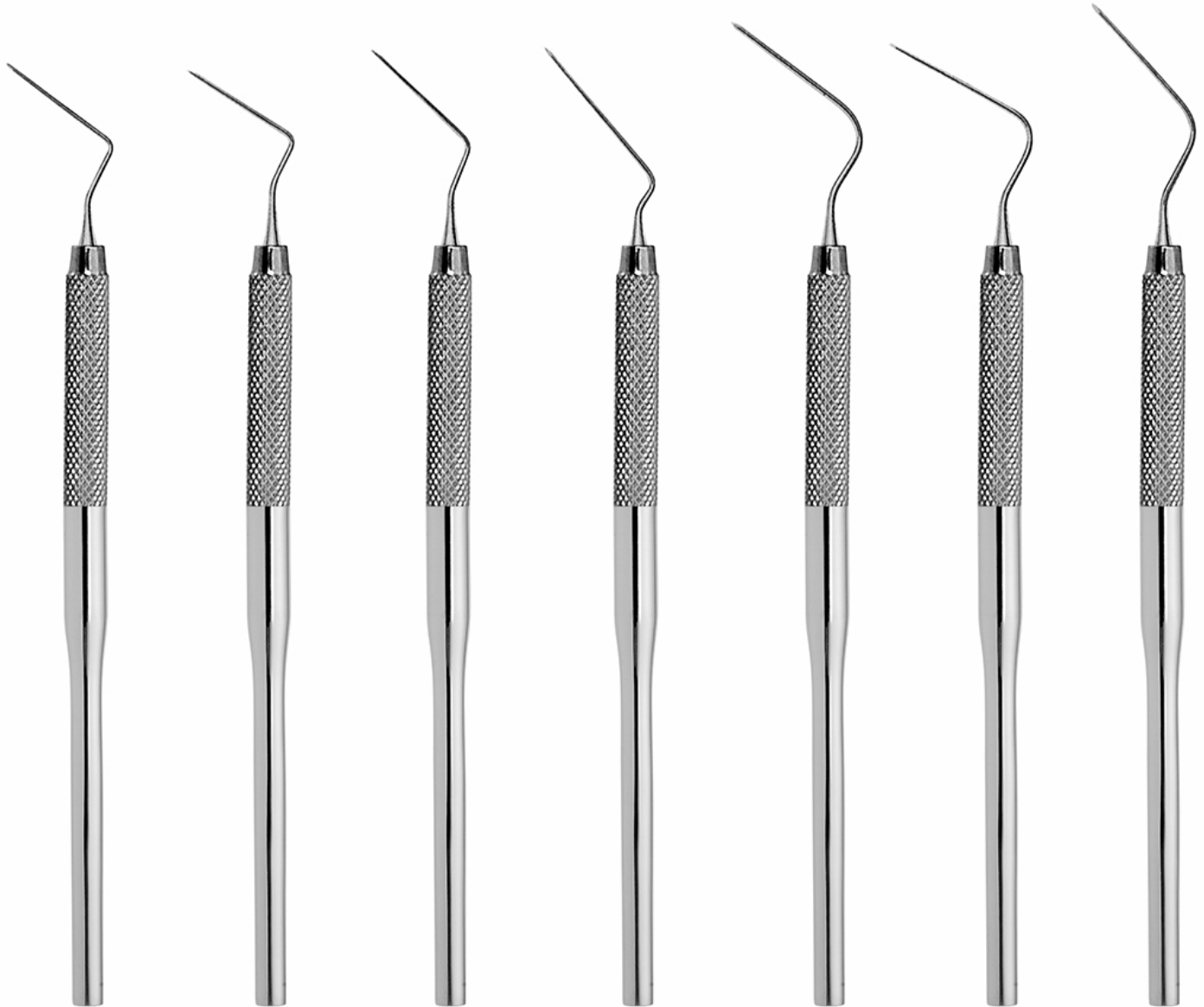

30.0515
Fig. 1
Spreader

30.0518
Fig. 2
Spreader

30.0521
Fig. 3
Spreader

30.0524
Fig. 4
Spreader

30.0527
Fig. 5
Spreader

30.0530
Fig. 6
Spreader

30.0533
Fig. 7
Spreader



- Зонды пародонтологические
- Sondes paradontales
- sonde parodontali

- зонди пародонтологічні
- Sondas paradontales
- المسابر اللثة

Root-Canal Pluggers

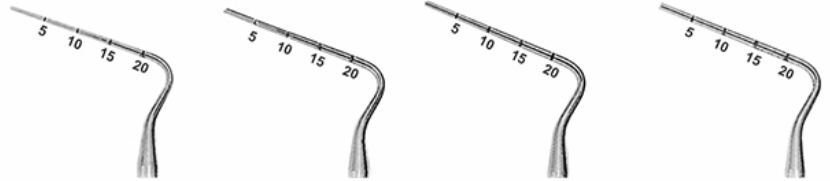

30.0537
Fig. 1
Luks

30.0540
Fig. 2
Luks

30.0543
Fig. 3
Luks

30.0546
Fig. 4
Luks

30.0549
Fig. 1
Vertical
condenser

30.0552
Fig. 2
Vertical
condenser

30.0555
Fig. 3
Vertical
condenser

30.0558
Fig. 4
Vertical
condenser

- Зонды пародонтологические
- Sondes parodontales
- sonda parodontali
- зонди пародонтологічні
- Sondas parodontales
- المسابر اللثة

Root-Canal Excavators



30.0561
Fig. 6/1



30.0564
Fig. 6/17



30.0567
Fig. 6/23



30.0570
Fig. 6/1



30.0573
Fig. 6/17



30.0576
Fig. 6/23



- Инструменты для реставрации
- Instruments pour plombage
- Füllungsinstrumente (mit Kontrawinkel)

- Інструменти для реставрації
- Instrumentos para obturaciones
- ملء الصكوك

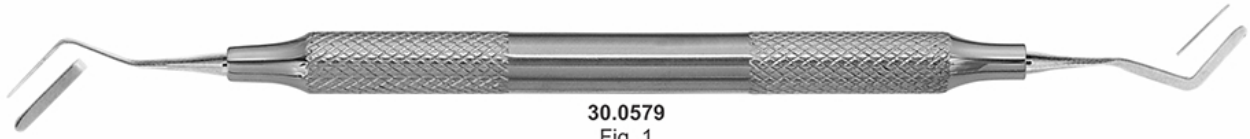

30.0579
Fig. 1

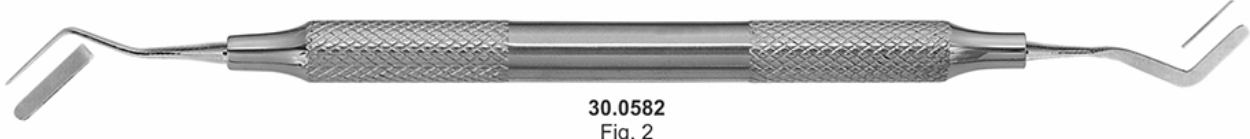

30.0582
Fig. 2

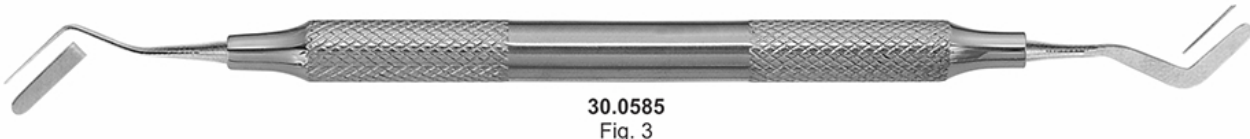

30.0585
Fig. 3

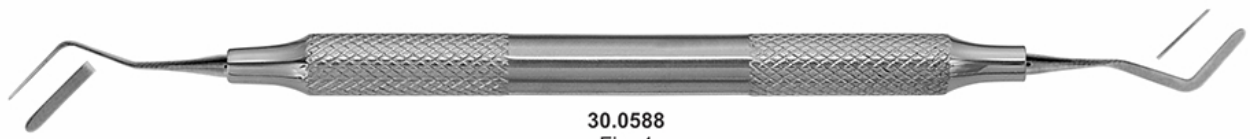

30.0588
Fig. 4
Gold Tips

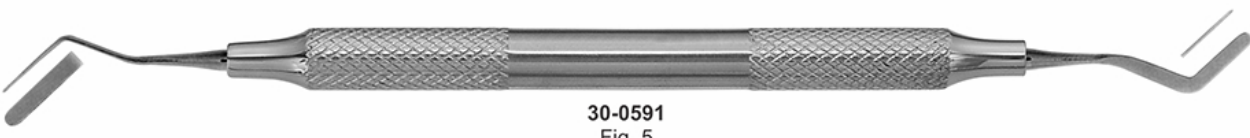

30.0591
Fig. 5
Gold Tips

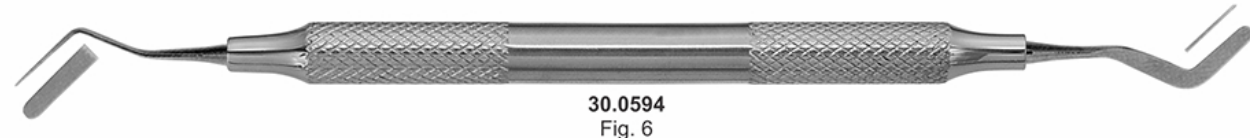

30.0594
Fig. 6
Gold Tips

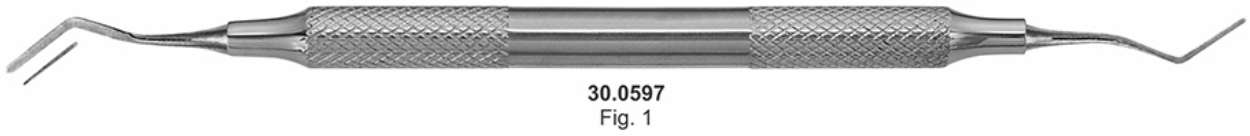

30.0597
Fig. 1

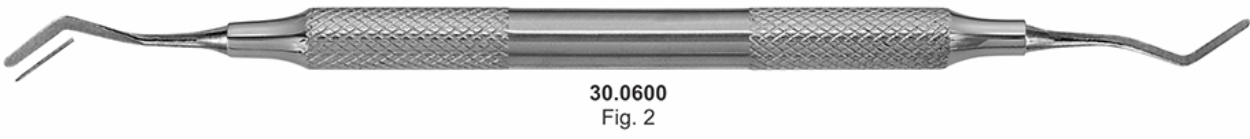

30.0600
Fig. 2

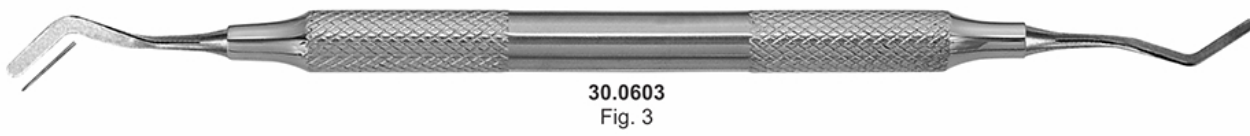

30.0603
Fig. 3

FILLING INSTRUMENTS

- Инструменты для реставрации
- Instruments pour plombage
- Füllungsinstrumente (mit Kontrawinkel)

- Інструменти для реставрації
- Instrumentos para obturaciones
- ملء الصكوك

Amalgam Instruments

Titanium Gold Tips

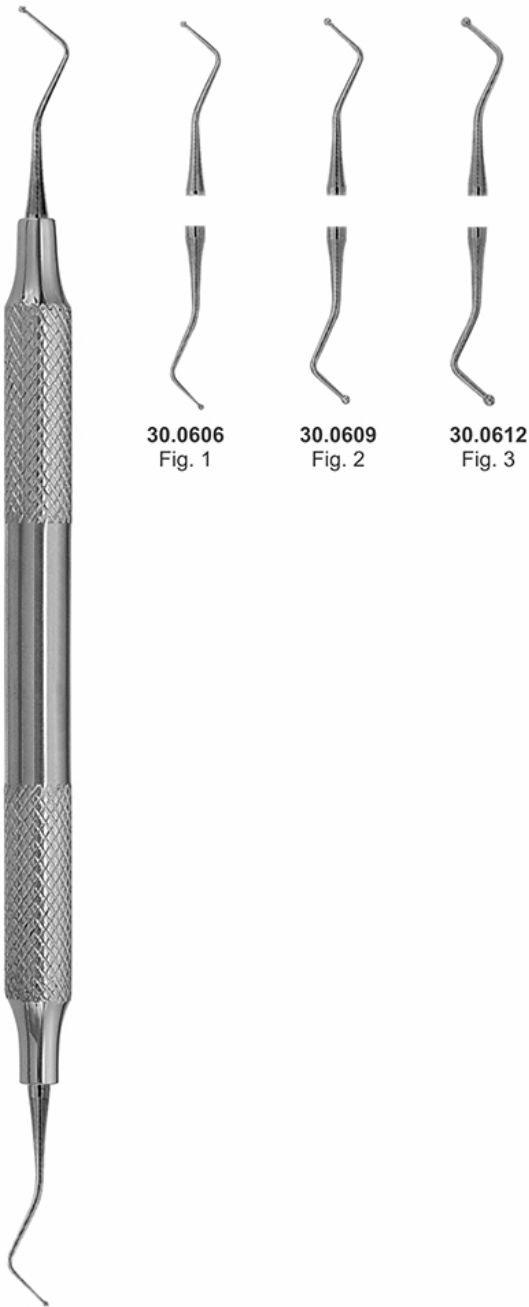

Serrated

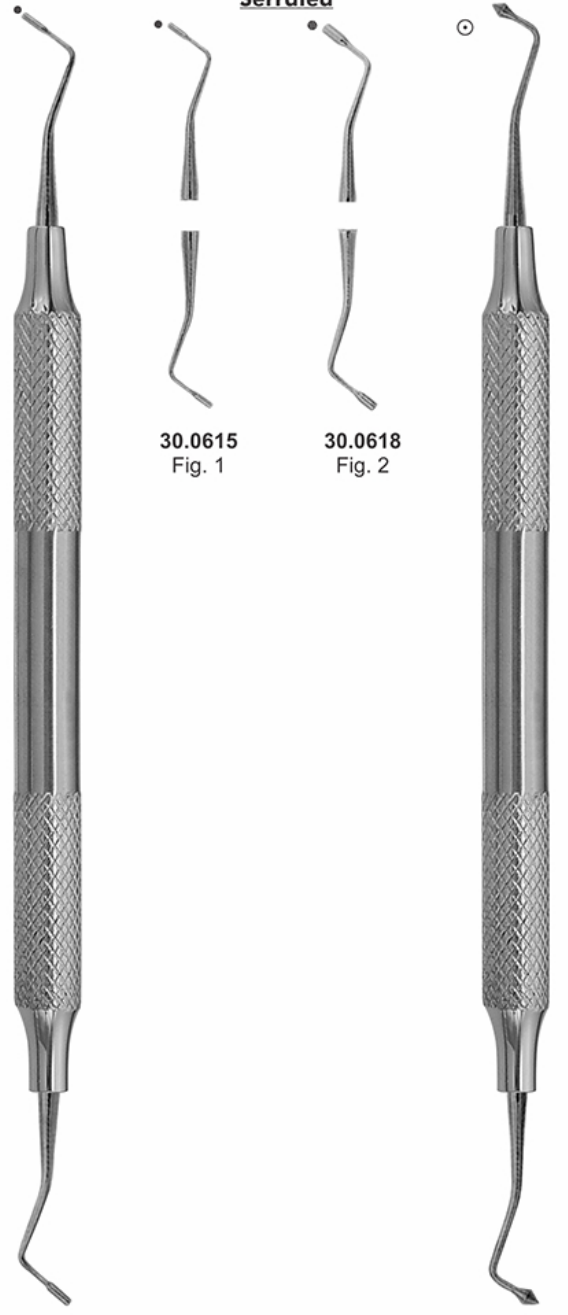

30.0621
Fig. 1
Westcott



- Инструменты для реставрации
- Instruments pour plombage
- Füllungsinstrumente (mit Kontrawinkel)

- Інструменти для реставрації
- Instrumentos para obturaciones
- ملء الصكوك



30.0624
Fig. 1



30.0627
Fig. 2



30.0630
Fig. 3



30.0633
Fig. 4



30.0636
Fig. 5



30.0639
Fig. 1



30.0642
Fig. 2



30.0645
Fig. 3



30.0648
Fig. 1L



30.0651
Fig. 2L



30.0654
Fig. 3L

FILLING INSTRUMENTS

- Инструменты для реставрации
- Instruments pour plombage
- Füllungsinstrumente (mit Kontrawinkel)

- Інструменти для реставрації
- Instrumentos para obturaciones
- ملء الصكوك



30.0657
Fig. 1



30.0660
Fig. 2



30.0663
Fig. 3



30.0666
Fig. 4



30.0669
Fig. 5



30.0672
Fig. 1



30.0675
Fig. 2



30.0678
Fig. 3



30.0681
Fig. 1L



30.0684
Fig. 2L



30.0687
Fig. 3L



FILLING INSTRUMENTS

- Инструменты для реставрации
- Instruments pour plombage
- Füllungsinstrumente (mit Kontrawinkel)

- Інструменти для реставрації
- Instrumentos para obturaciones
- ملء الصكوك

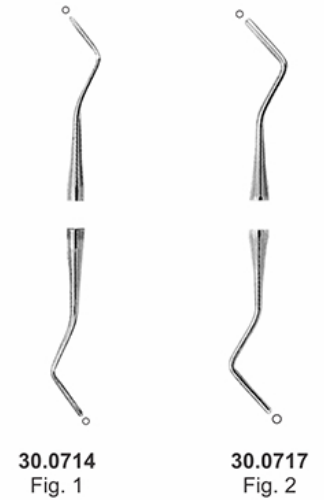
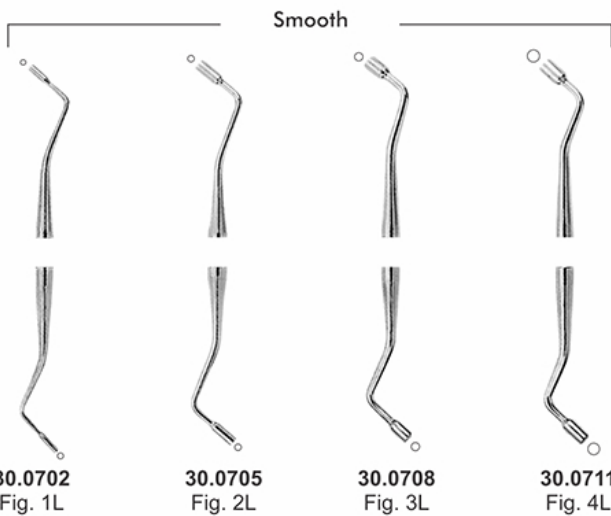
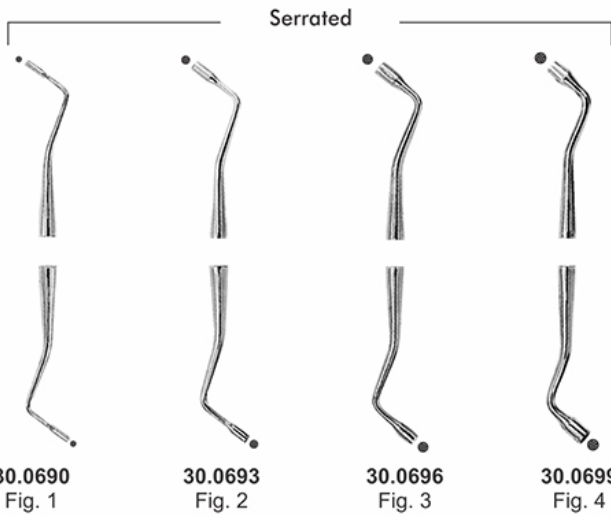

FILLING INSTRUMENTS

- Инструменты для реставрации
- Instruments pour plombage
- Füllungsinstrumente (mit Kontrawinkel)

- Інструменти для реставрації
- Instrumentos para obturaciones
- ملء الصكوك

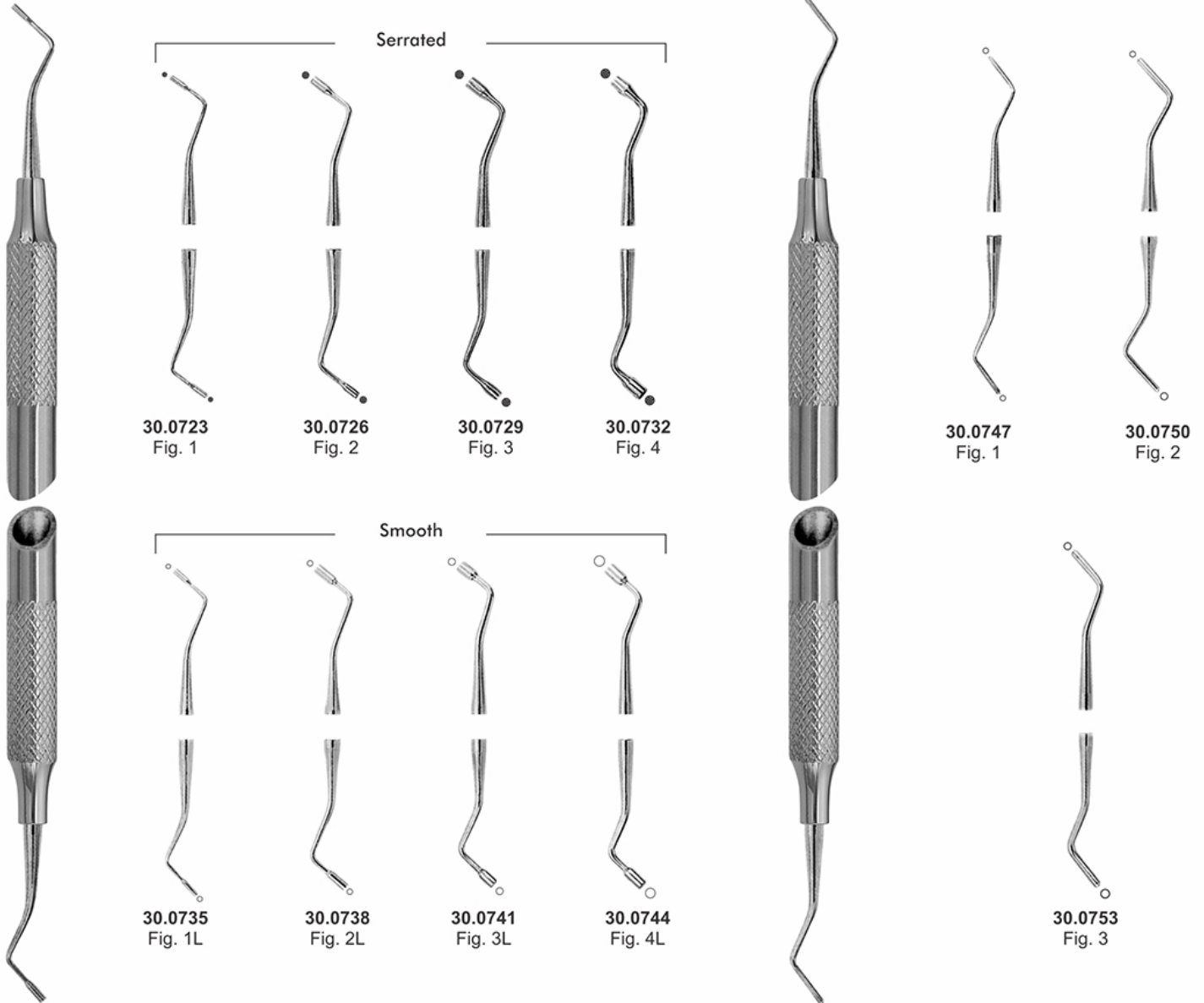



- Инструменты для реставрации
- Instruments pour plombage
- Füllungsinstrumente (mit Kontrawinkel)

- Інструменти для реставрації
- Instrumentos para obturaciones
- ملء الصكوك

Amalgam Instruments

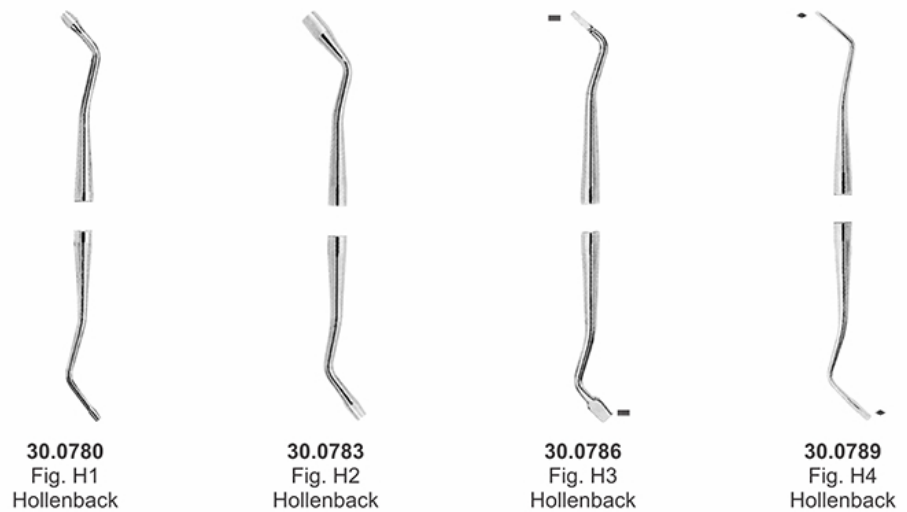
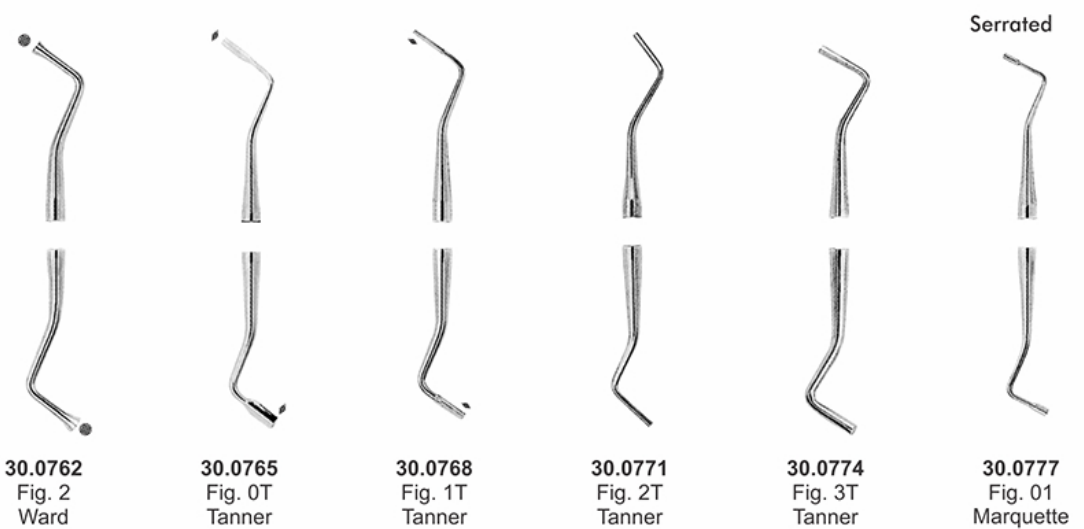

FILLING INSTRUMENTS

- Инструменты для реставрации
- Instruments pour plombage
- Füllungsinstrumente (mit Kontrawinkel)
- Инструменти для реставрації
- Instrumentos para obturaciones
- ملء الصكوك

Markley Amalgam Instruments

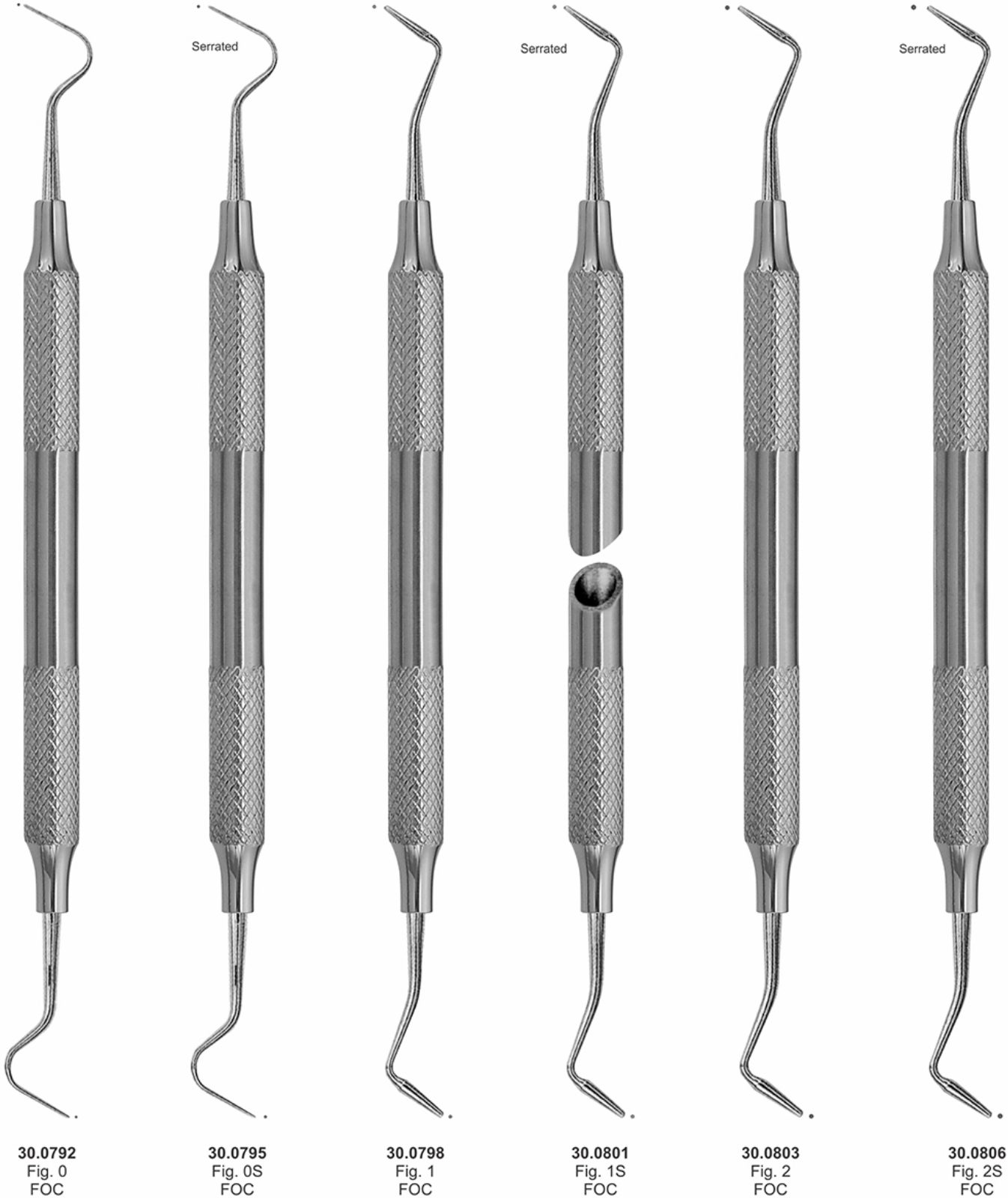



- Инструменты для реставрации
- Instruments pour plombage
- Füllungsinstrumente (mit Kontrawinkel)

- Інструменти для реставрації
- Instrumentos para obturaciones
- ملء الصكوك

Markley Amalgam Instruments

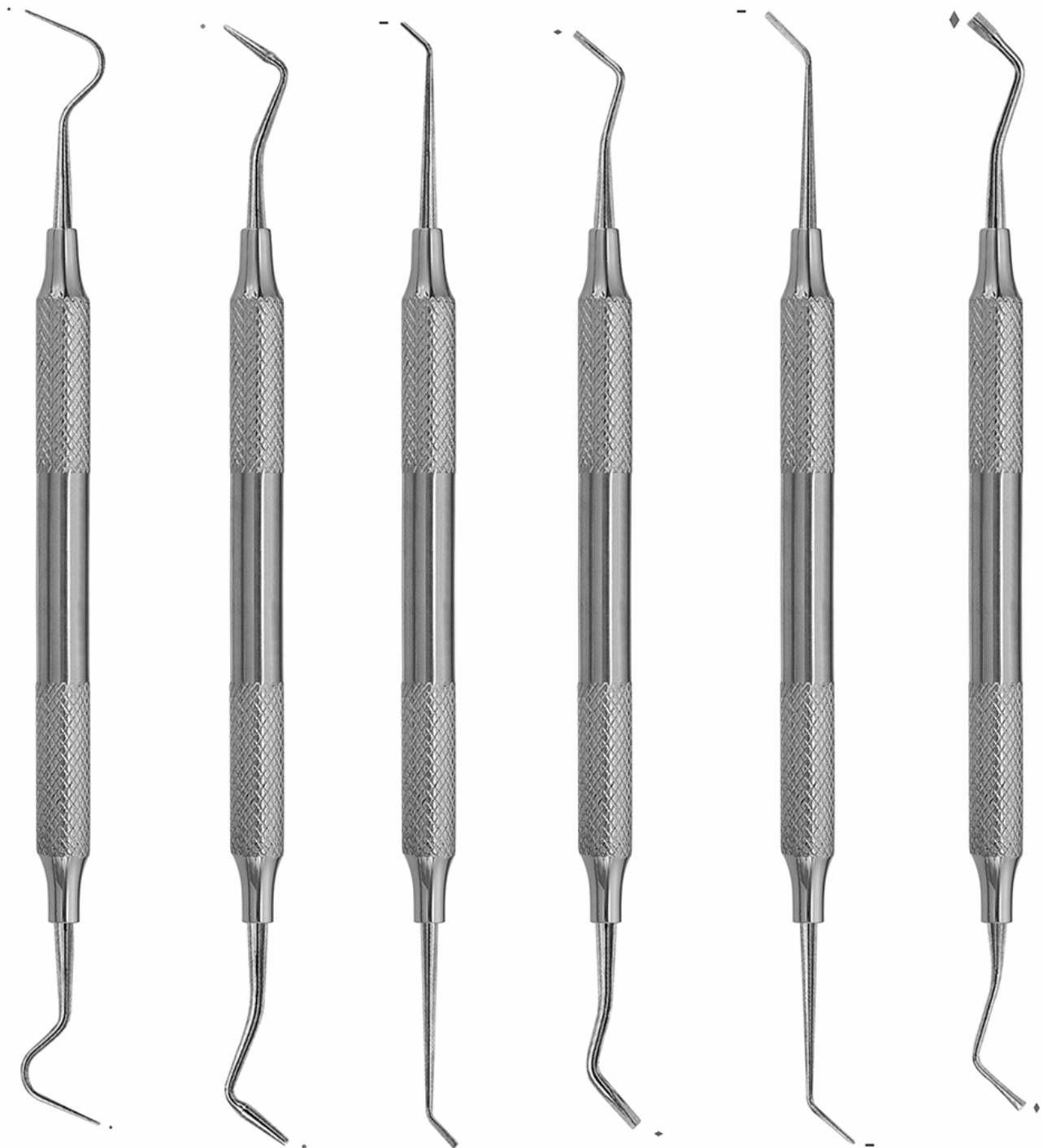

30.0809
Fig. 1
Markley

30.0812
Fig. 2
Markley

30.0815
Fig. 3
Markley

30.0818
Fig. 4
Markley

30.0821
Fig. 5
Markley

30.0824
Fig. 6
Markley

FILLING INSTRUMENTS

- Инструменты для реставрации
- Instruments pour plombage
- Füllungsinstrumente (mit Kontrawinkel)

- Інструменти для реставрації
- Instrumentos para obturaciones
- ملء الصكوك

Ladmore Burnisher



30.0827
Fig. 1
Westcott



30.0830
Fig. 2
Westcott



30.0833
Fig. 2
Ladmore



30.0836
Fig. 3
Ladmore



30.0839
Fig. 18
Ball



30.0842
Fig. 26-27S
Ball



30.0845
Fig. 27-29
Ball



30.0848
Fig. A



30.0851
Fig. W3



30.0854
Fig. NYU/B2



30.0857
Fig. 2/31

- Инструменты для реставрации
- Instruments pour plombage
- Füllungsinstrumente (mit Kontrawinkel)

- Інструменти для реставрації
- Instrumentos para obturaciones
- ملء الصكوك

Burnishers



30.0860
Fig. 1
Westcott



30.0863
Fig. 2
Westcott



30.0866
Fig. 2
Ladmore



30.0869
Fig. 3
Ladmore



30.0871
Fig. 18
Ball



30.0874
Fig. 26-27S
Ball



30.0877
Fig. 27-29
Ball

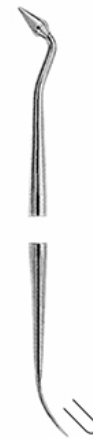

30.0880
Fig. NYU/B2



30.0883
Fig. 2/31

FILLING INSTRUMENTS

- Инструменты для реставрации
- Instruments pour plombage
- Füllungsinstrumente (mit Kontrawinkel)

- Інструменти для реставрації
- Instrumentos para obturaciones
- ملء الصكوك

Burnishers



30.0886
Fig. 1
Westcott



30.0889
Fig. 2
Westcott



30.0892
Fig. 2
Ladmore



30.0895
Fig. 3
Ladmore



30.0898
Fig. 18
Ball



30.0901
Fig. 26-27S
Ball



30.0904
Fig. 27-29
Ball

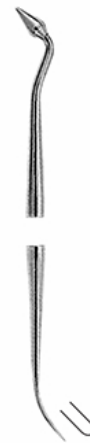

30.0907
Fig. NYU/B2



30.0910
Fig. 2/31



- Инструменты для реставрации
- Instruments pour plombage
- Füllungsinstrumente (mit Kontrawinkel)

- Інструменти для реставрації
- Instrumentos para obturaciones
- ملء الصكوك

Plastic Filling Instruments with Titanium Nitride Coated Tips



30.0913
Fig. 1
Gold Tip



30.0916
Fig. 2
Gold Tip



30.0919
Fig. 3
Gold Tip



30.0922
Fig. 2
Gold Tip



30.0925
Fig. 2
Gold Tip

FILLING INSTRUMENTS

- Инструменты для реставрации
- Instruments pour plombage
- Füllungsinstrumente (mit Kontrawinkel)

- Інструменти для реставрації
- Instrumentos para obturaciones
- ملء الصكوك



30.0928
Fig. 1



30.0931
Fig. 1



30.0934
Fig. 2



30.0937
Fig. 3



30.0940
Fig. 2



30.0943
Fig. 1



30.0946
Fig. 2



30.0949
Fig. 1



30.0952
Fig. 1



30.0955
Fig. 2



30.0958
Fig. 3



30.0961
Fig. 2



30.0964
Fig. 3



FILLING INSTRUMENTS

- Инструменты для реставрации
- Instruments pour plombage
- Füllungsinstrumente (mit Kontrawinkel)

- Інструменти для реставрації
- Instrumentos para obturaciones
- ملء الصكوك



30.0970
Fig. 1



30.0973
Fig. 2



30.0976
Fig. 3



30.0979
Fig. 2



30.0982
Fig. 1



30.0985
Fig. 2



30.0988
Fig. 1



30.0991
Fig. 1



30.0994
Fig. 2



30.0997
Fig. 3



30.1000
Fig. 2



30.1001
Fig. 3

- Инструменты для реставрации
- Instruments pour plombage
- Füllungsinstrumente (mit Kontrawinkel)
- Інструменти для реставрації
- Instrumentos para obturaciones
- ملء الصكوك

Woodson Plastic Filling Instrument



30.1004
Fig. 1
Woodson



30.1007
Fig. 11



30.1010
Fig. 6



30.1013
Fig. 179



30.1022
Fig. 1
Woodson



30.1025
Fig. 11



30.1028
Fig. 6



30.1031
Fig. 179



30.1016
Fig. 2
Woodson



30.1019
Fig. 3
Woodson



30.1034
Fig. 2
Woodson



30.1037
Fig. 3
Woodson



FILLING INSTRUMENTS

- Инструменты для реставрации
- Instruments pour plombage
- Füllungsinstrumente (mit Kontrawinkel)

- Інструменти для реставрації
- Instrumentos para obturaciones
- ملء الصكوك

Gauze Packers



30.1040
2 mm
Luniatschek

30.1043
3 mm
Luniatschek

Instrument for subgingival application of tinctures and medicaments



30.1046
Orban Loop

30.1049

Placement Instruments



30.1052

30.1055

30.1058

30.1061

- Инструменты для реставрации
- Instruments pour plombage
- Füllungsinstrumente (mit Kontrawinkel)
- Инструменти для реставрації
- Instrumentos para obturaciones
- ملء الصكوك

Black, Wedelstaet Cavity Preparation Instruments



30.1064
Black/26
Distal



30.1067
Fig. 1
Black/53-54



30.1070
Fig. 2
Black/51-52



30.1073
Fig. 1/2
Wedelstaet



30.1076
Fig. 3/4
Wedelstaet



30.1079
Fig. 5/6
Wedelstaet

Gingival Margin Trimmers



30.1082
Fig. 2
Black/27
Mesial



30.1085
Fig. 3
Black/28
Distal



30.1088
Fig. 4
Black/29
Mesial



30.1091
Fig. 1
Black/77-78
Distal



30.1094
Fig. 2
Black/79-80
Mesial

- Инструменты для реставрации
- Instruments pour plombage
- Füllungsinstrumente (mit Kontrawinkel)

- Інструменти для реставрації
- Instrumentos para obturaciones
- ملء الصكوك

Black, Wedelstaet Cavity Preparation Instruments



30.1100
Fig. 1
Black/53-54

30.1103
Fig. 2
Black/51-52

30.1106
Fig. 1/2
Wedelstaet

30.1109
Fig. 3/4
Wedelstaet

30.1112
Fig. 5/6
Wedelstaet



Gingival Margin Trimmers



30.1115
Fig. 2
Black/27
Mesial

30.1118
Fig. 3
Black/28
Distal

30.1121
Fig. 4
Black/29
Mesial

30.1124
Fig. 1
Black/77-78
Distal

30.1127
Fig. 2
Black/79-80
Mesial

30.1097
Fig. 1
Black/26
Distal

AMALGAM CARVERS

- Инструменты для реставрации
- Instruments pour amalgame
- Amalgampistolen

- Инструменти для реставрації
- instrumentos para amalgama
- تقطيع الملغم

Ward & Hollenback Small Amalgam Carver Fig. 1/2

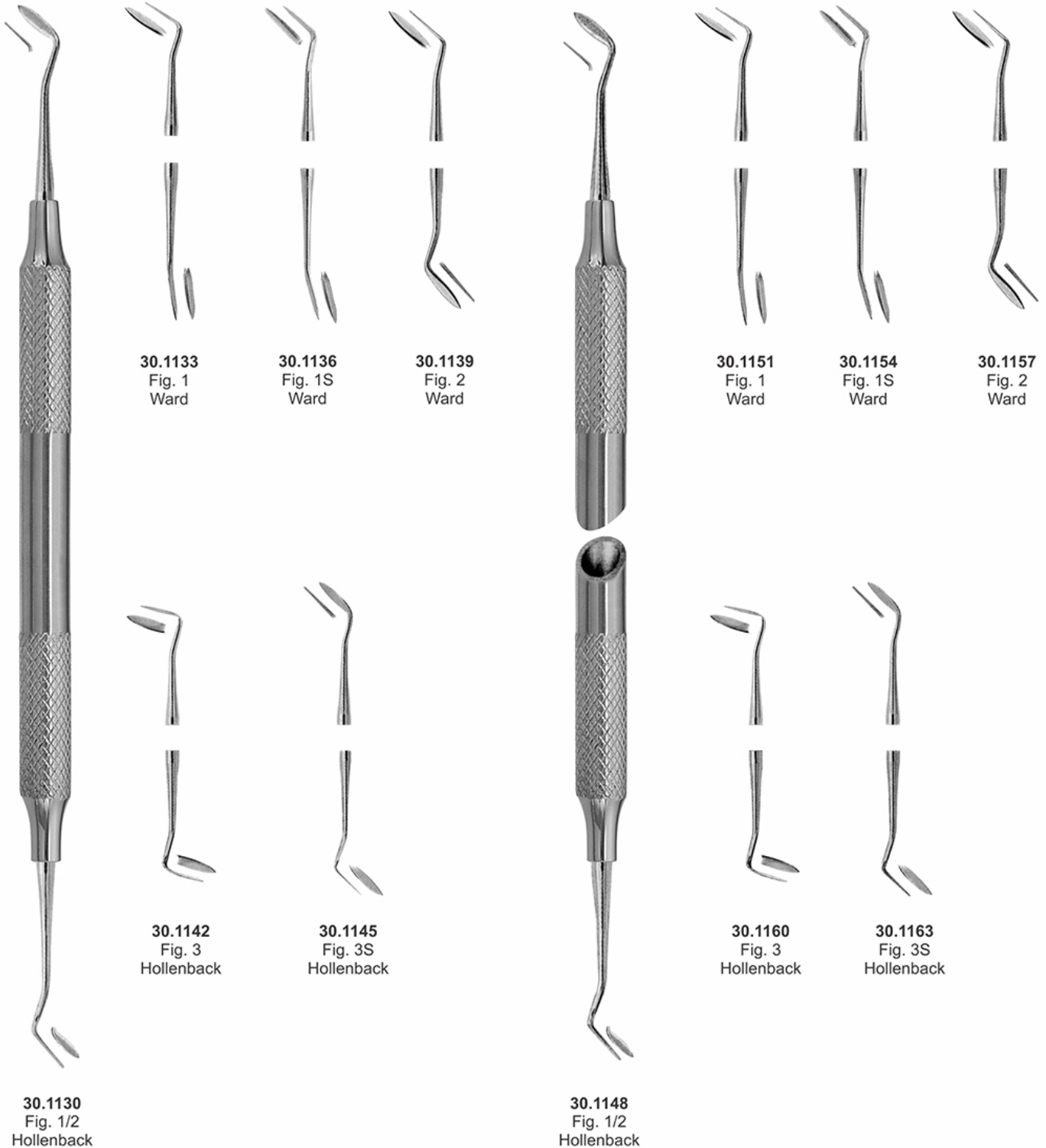

- Инструменты для реставрации
- Instruments pour amalgame
- Amalgampistolen

- Инструменти для реставрації
- instrumentos para amalgama
- تقطيع الملغم

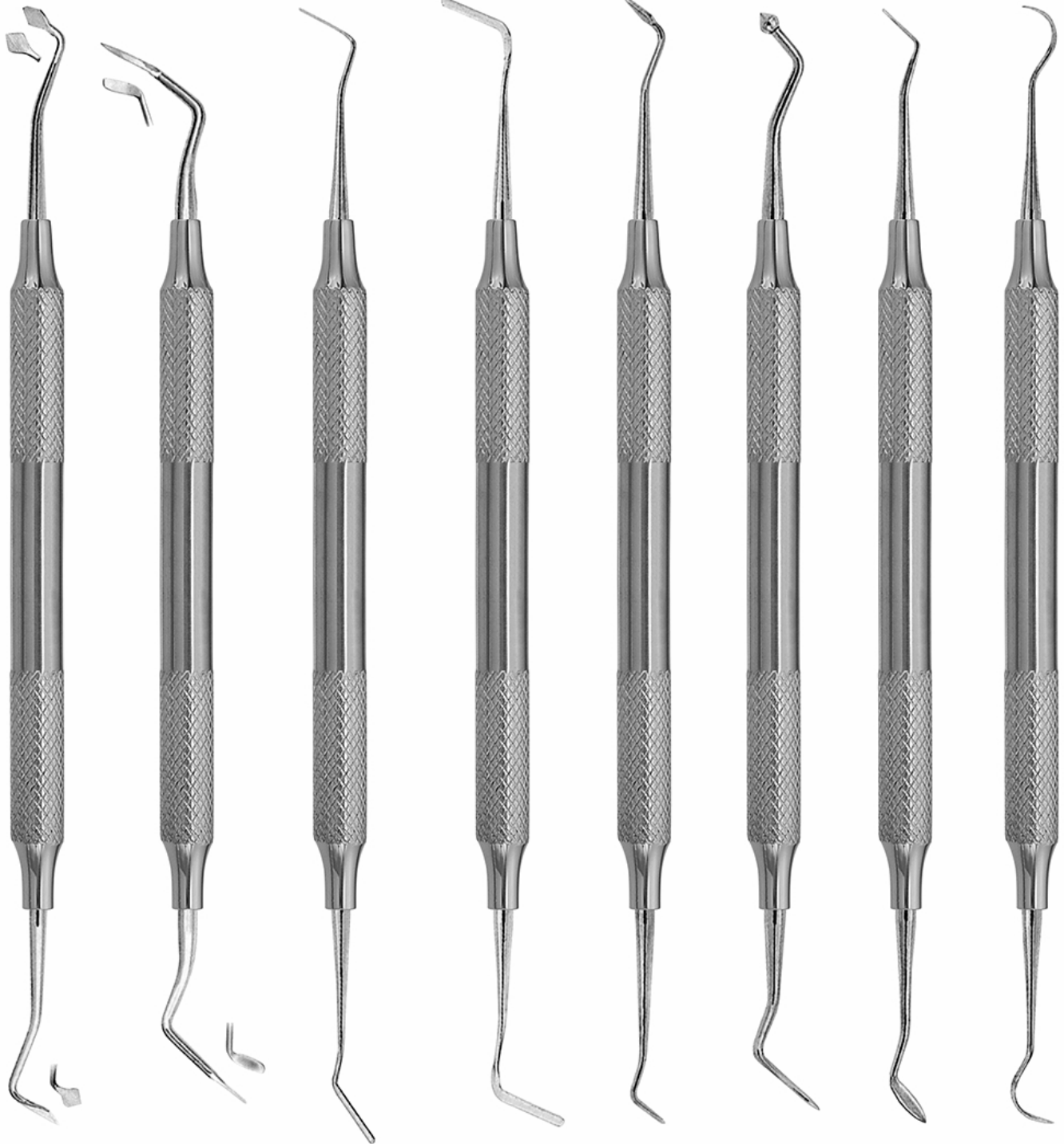

30.1167
Fig. 1
Frahm

30.1170
Fig. 2
USC

30.1173
Fig. 1
Interproximal

30.1176
Fig. 2
Interproximal
Off-Angle

30.1179
Fig. SHO-A

30.1182
Fig. 3-SHO

30.1185
Fig. 104

30.1188
Fig. 8
Wiland

AMALGAM CARVERS

- Инструменты для реставрации
- Instruments pour amalgame
- Amalgampistolen

- Инструменти для реставрації
- instrumentos para amalgama
- تقطع الملغم

Wiland amalgam carver for interproximal fillings

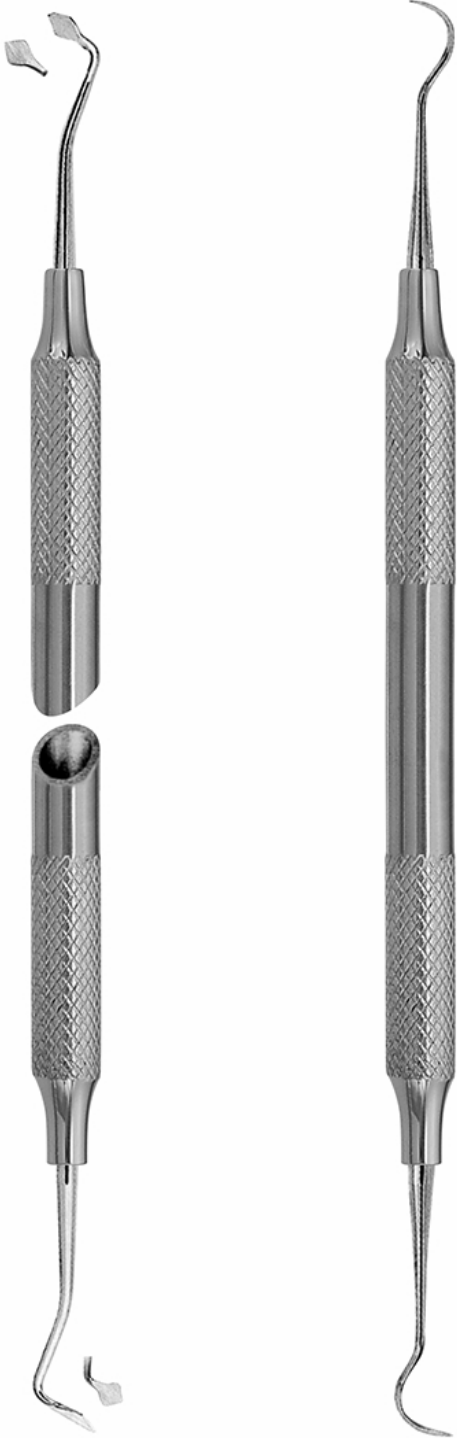

30.1191
Fig. 1
Frahm

30.1194
Fig. 8
Wiland

Instruments For Retractor Wire

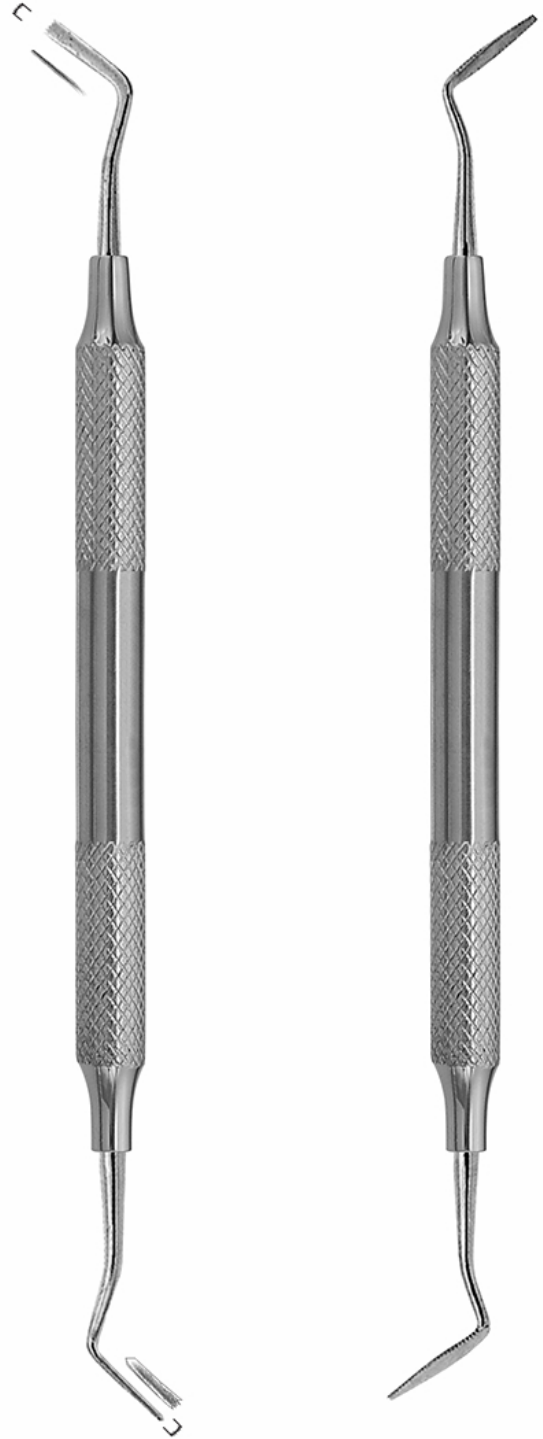

30.1197

30.1200

- Инструменты для реставрации
- Instruments pour amalgame
- Amalgampistolen

- Инструменти для реставрації
- instrumentos para amalgama
- تقطيع الملغم

Cleoids-Discoids Amalgam Carver Round Working Tip

Cleoids-Discoids Amalgam Carver, Oval Working Tip

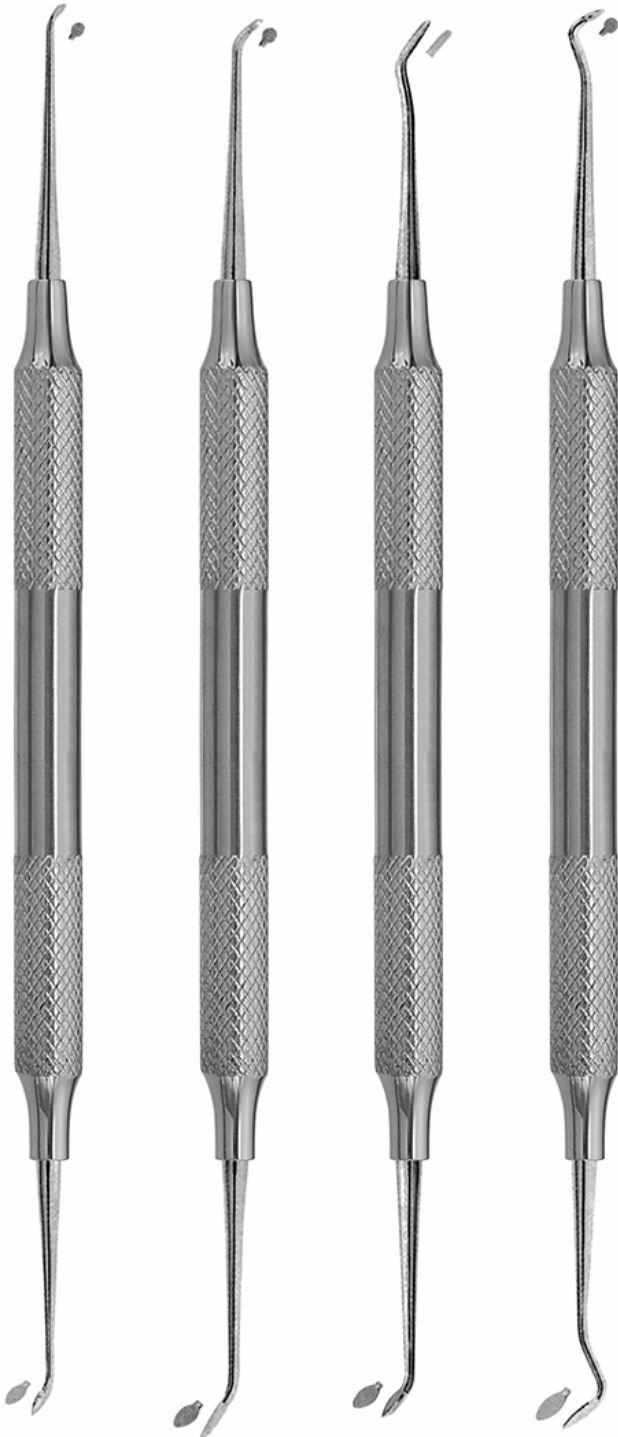

30.1201
Fig. 1

30.1204
Fig. 2

30.1207
Fig. 3

30.1210
Fig. 4

Cleoids-Discoids

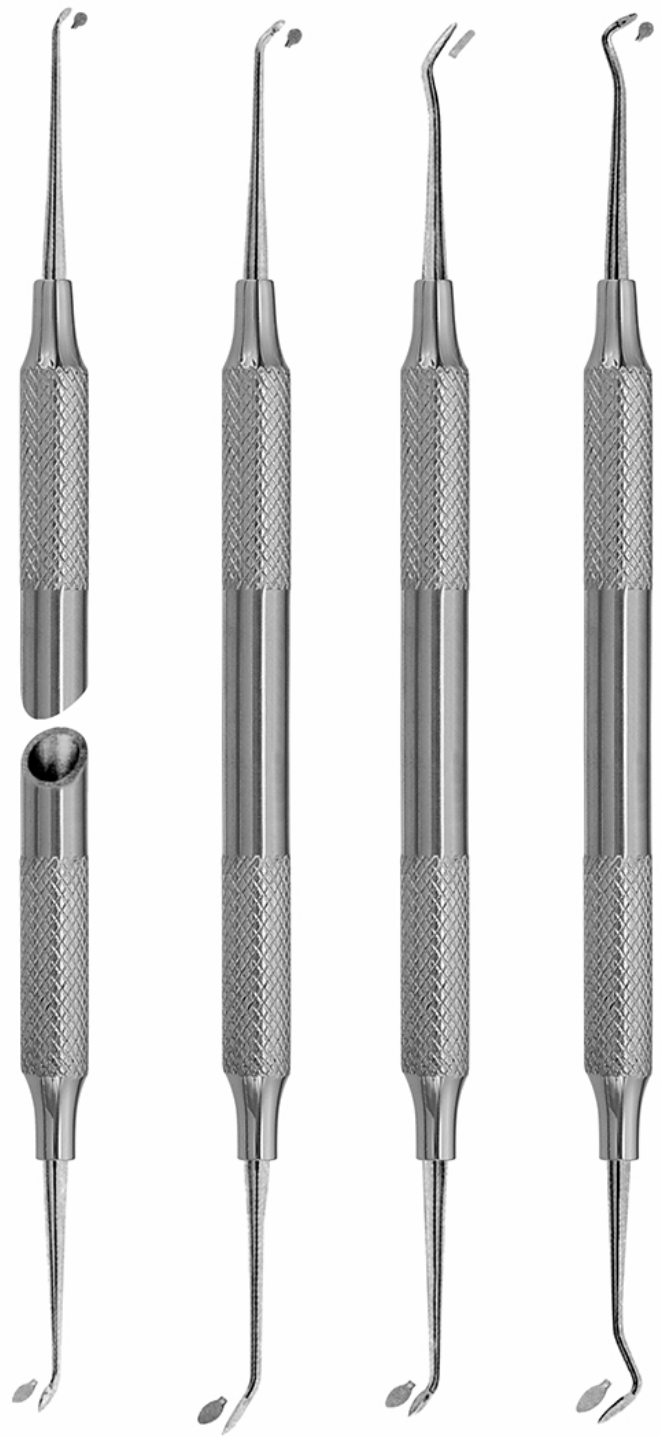

30.1213
Fig. 1

30.1216
Fig. 2

30.1219
Fig. 3

30.1222
Fig. 4

Cleoids-Discoids

CARVERS INSTRUMENTS

- Инструменты для реставрации
- Instruments a modeler
- Modellierinstrumente

- Инструменти для реставрації
- Instrumentos para modelar
- أدوات تقطيع

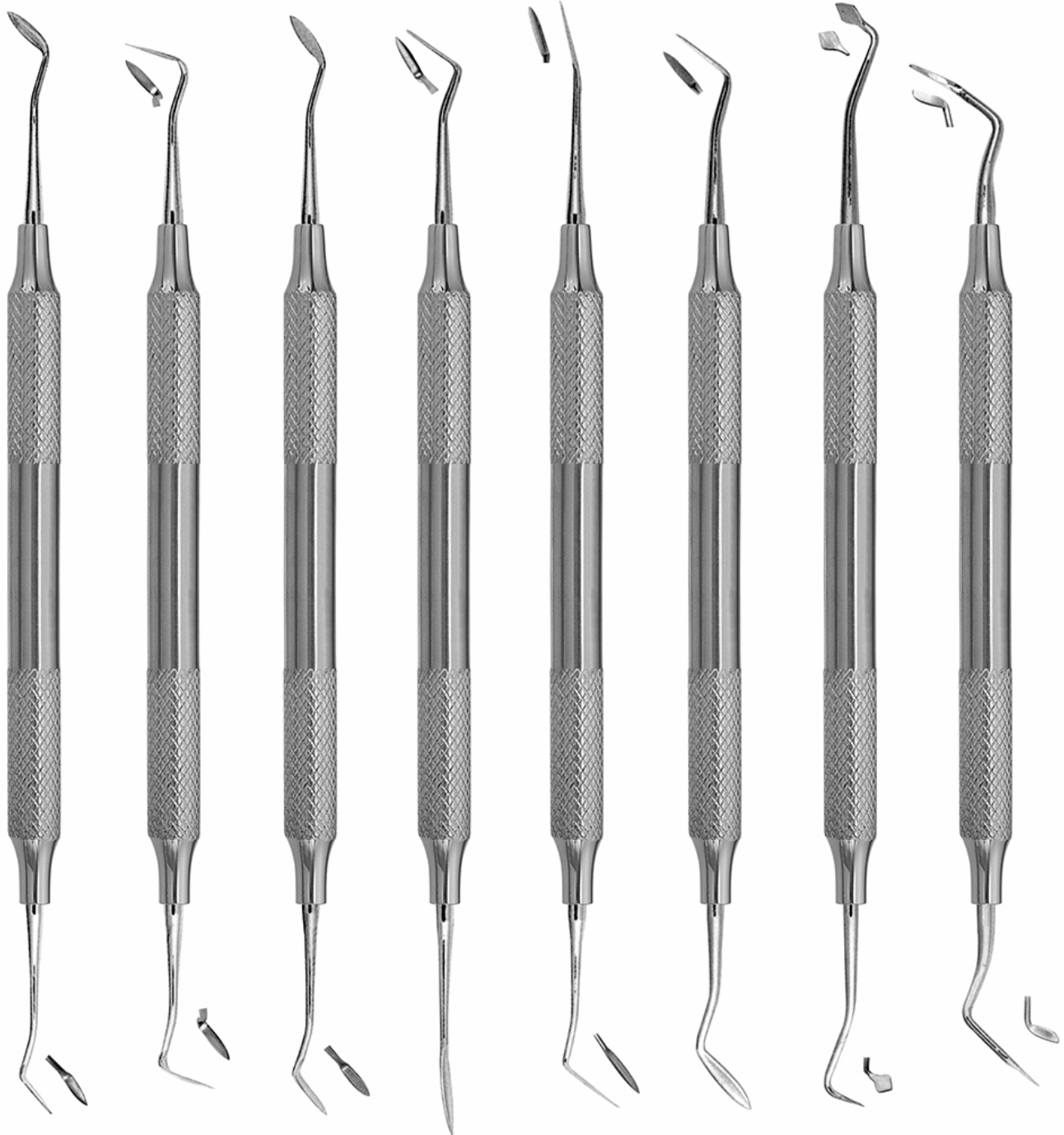

30.1225
Fig. 1/2
Hollenback

30.1228
Fig. 3
Hollenback

30.1231
Fig. 3S
Hollenback

30.1234
Fig. 1
Ward

30.1237
Fig. 1S
Ward

30.1240
Fig. 2
Ward

30.1243
Fig. 1
Frahm

30.1246
Fig. 2
USC



- Инструменты для реставрации
- Instruments a modeler
- Modellierinstrumente

- Інструменти для реставрації
- Instrumentos para modelar
- أدوات تقطيع



30-1249

Graded Handle Hylin Carver

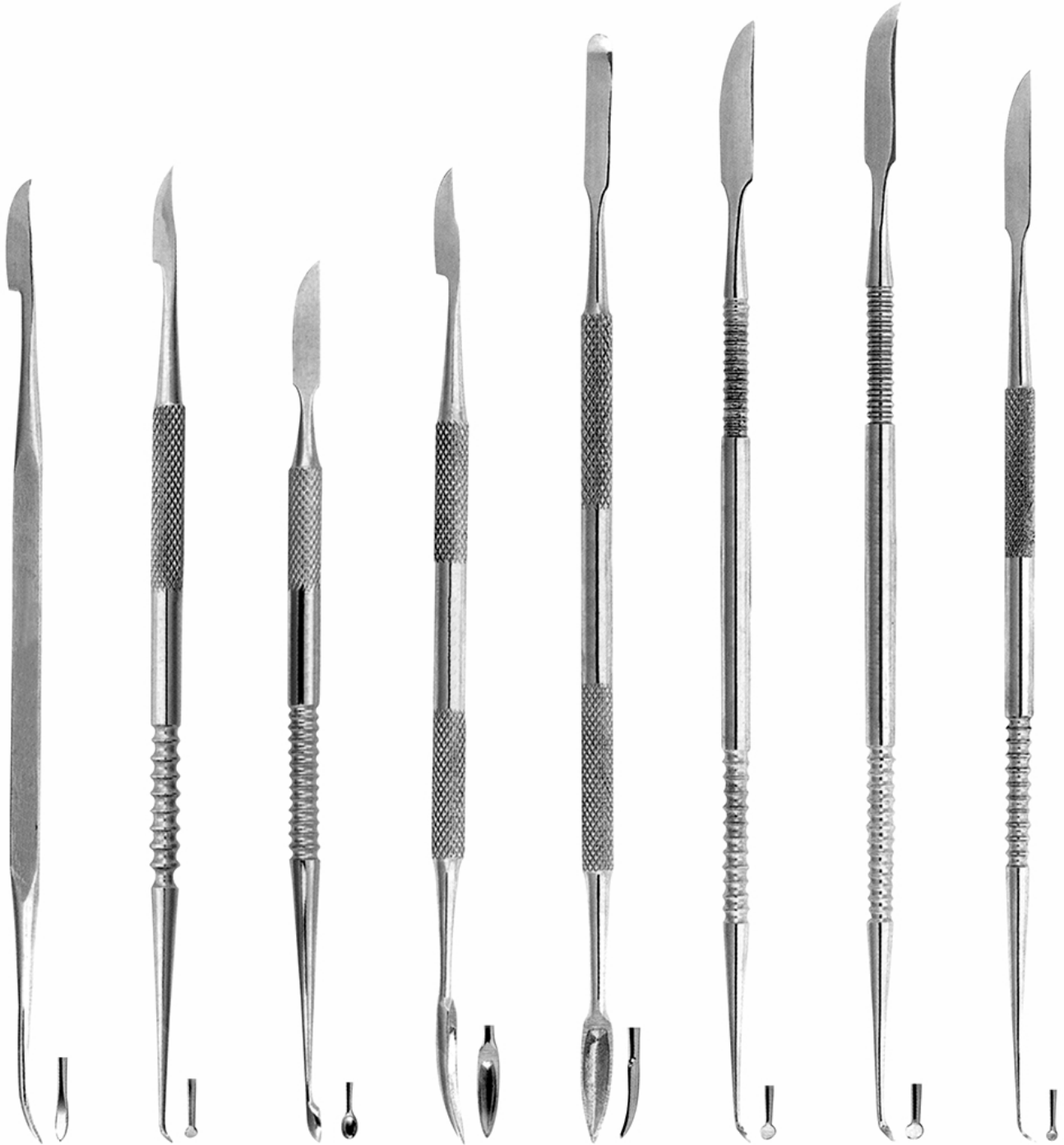

30.1252
Hylin

30.1255
Hylin-Le Cron

30.1258
Hylin-Ceramica

30.1261
Hylin

30.1263

30.1266
Le Cron

30.1269
Le Cron

30.1272
Le Cron

CARVERS INSTRUMENTS



acme surgical®

- Инструменты для реставрации
- Instruments a modeler
- Modellierinstrumente

- Инструменти для реставрації
- Instrumentos para modelar
- أدوات تقطيع



30.1275
Le Cron



30.1278
Zahle



30.1281
Zahle



30.1284
Zahle



30.1287
Gritman



30.1290
Beale



30.1293
Roach



30-1296
Vehe

- Инструменты для реставрации
- Instruments a modeler
- Modellierinstrumente

- Інструменти для реставрації
- Instrumentos para modelar
- أدوات تقطیع



30.1299
Fig. 1
P.K Thomas



30.1302
Fig. 2
P.K Thomas



30.1305
Fig. 3
P.K Thomas



30.1308
Fig. 4
P.K Thomas



30.1311
Fig. 5
P.K Thomas

CEMENT SPATULAS

- Шпатели для цемента
- Spatules à ciment
- Zementspatel
- Шпателі для цементу
- Espátulas para cemento
- ملاعق الأسمنت



30.1314
Fig. 1



30.1317
Fig. 2



30.1320
Fig. 3



30.1323
Fig. 00



30.1326
Fig. 0



30.1329
Fig. 1



30.1332
Fig. 2



30.1335
Fig. 3



30.1338
Fig. 4



30.1341
Weston

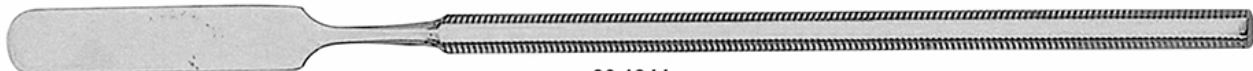

30.1344



30.1347



CEMENT SPATULAS

- Шпатели для цемента
- Spatules à ciment
- Zementspatel

- Шпателі для цементу
- Espátulas para cemento
- ملاعق الأسمنت



30.1350
Fig. 1



30.1353
Fig. 2



30.1356
Fig. 00



30.1359
Fig. 0



30.1362
Fig. 1



30.1365
Fig. 2



30.1368
Fig. 3



30.1371
Fig. 4

EXCAVATORS

- Экскаваторы
- Excavateurs
- Excavatoren
- حفارات
- Екскаватори
- Excavadores

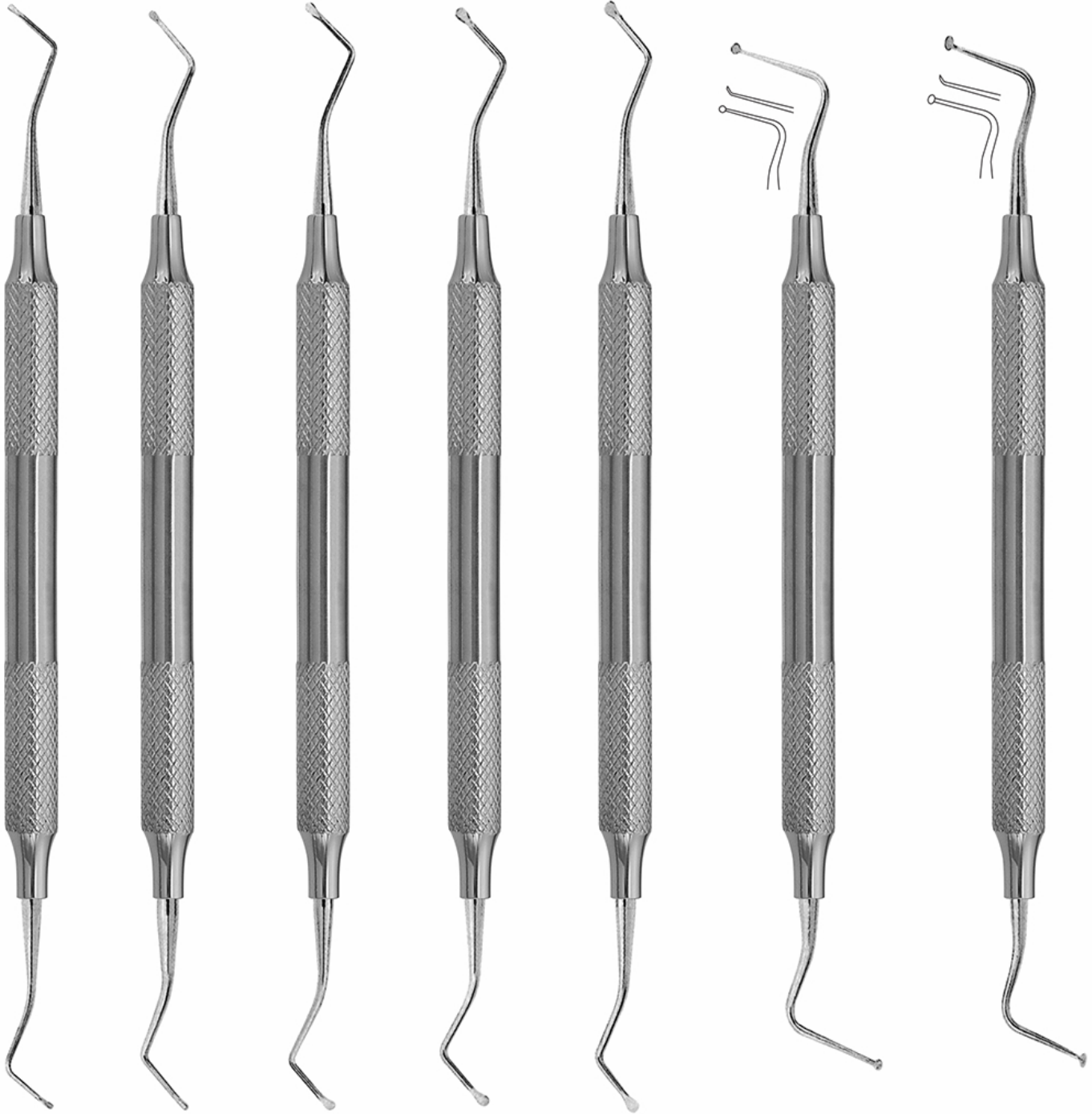

30.1374
Fig. 0

30.1377
Fig. 1

30.1380
Fig. 2

30.1383
Fig. 3

30.1386
Fig. 4

30.1389
Fig. 1

30.1392
Fig. 2

- Экскаваторы
- Excavateurs
- Excavatoren

- Экскаватори
- Excavadores
- حفارات

Excavator For Manual Removal of Decay Tissue

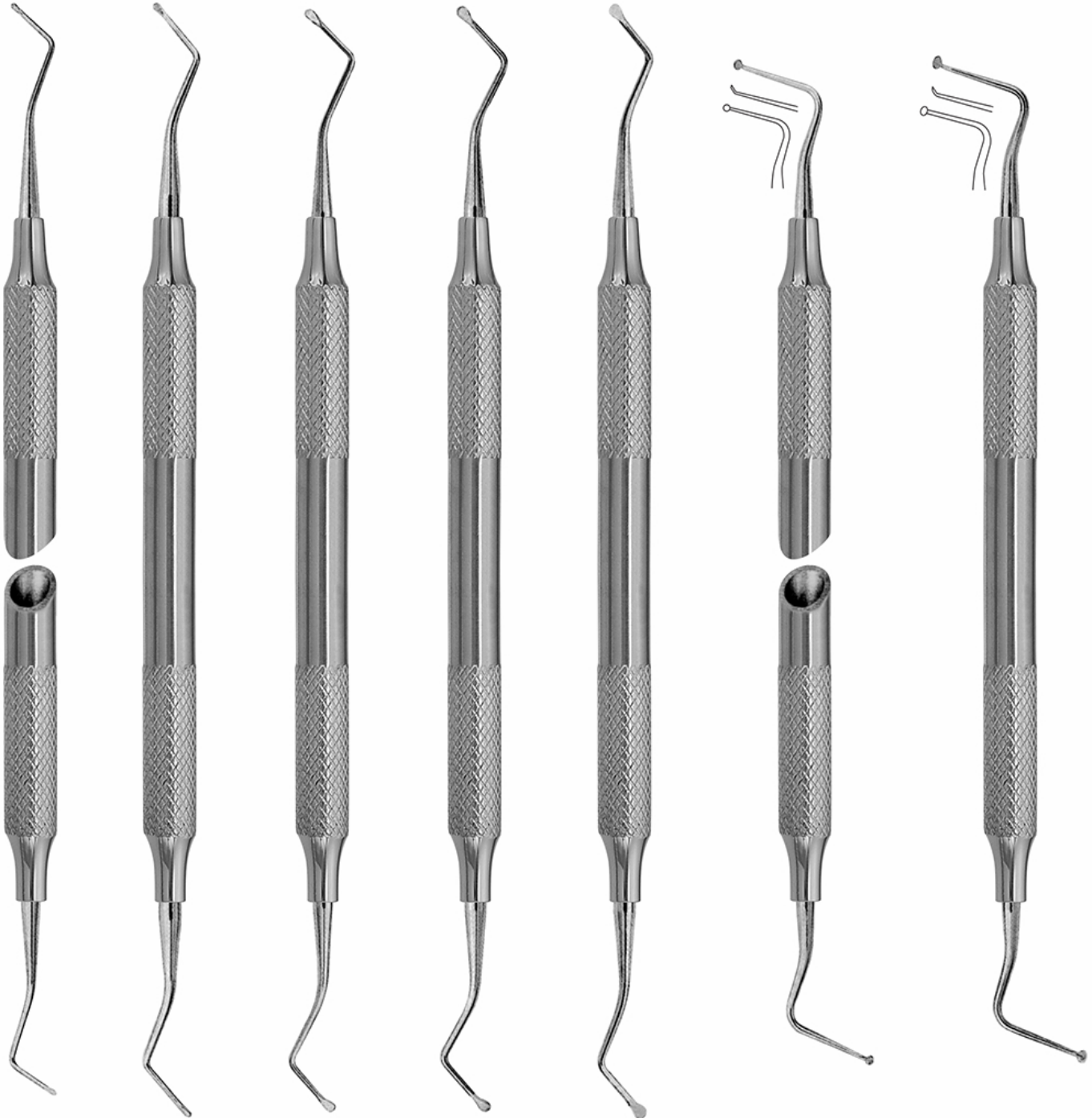

30.1395
Fig. 0

30.11398
Fig. 1

30.1401
Fig. 2

30.1404
Fig. 3

30.1407
Fig. 4

30.1410
Fig. 1

30.1413
Fig. 2

EXCAVATORS

- Экскаваторы
- Excavateurs
- Excavatoren

- عسكافطوري
- Excavadores
- حفارات



30.1417
Fig. 6

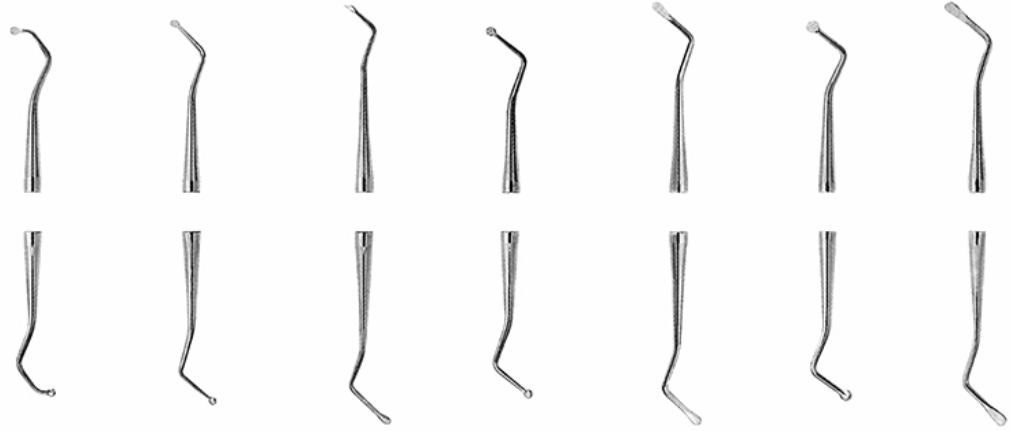

30.1420
Fig. 14

30.1423
Fig. 17

30.1426
Fig. 17W
Oval spoon

30.1429
Fig. 18

30.1432
Fig. 18W
Oval spoon

30.1435
Fig. 19

30.1438
Fig. 19W
Oval spoon

Angular Shaped Excavator with Rounded Tip



30-1441
Fig. 6



30.1444
Fig. 14

30.1447
Fig. 17

30.1450
Fig. 17W
Oval spoon

30.1453
Fig. 18

30.1456
Fig. 18W
Oval spoon

30.1459
Fig. 19

30.1462
Fig. 19W
Oval spoon

- Экскаваторы
- Excavateurs
- Excavatoren

- Экскаватори
- Excavadores
- حفارات



30.1465
Fig. 38/39



30.1468
Fig. 63/64

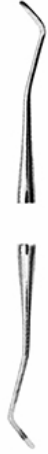

30.1471
Fig. 65/66



30.1474
Fig. 31L

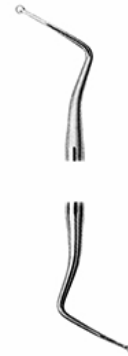

30.1477
Fig. 32L



30.1480
Fig. 33L



30.1483
Fig. 38/39



30.1486
Fig. 63/64



30.1489
Fig. 65/66



30.1492
Fig. 31L



30.1495
Fig. 32L



30.1498
Fig. 33L

EXCAVATORS

- Экскаваторы
- Excavateurs
- Excavatoren

- Экскаватори
- Excavadores
- حفارات

Excavator For Manual Removal of Decay Tissue

1 mm



30.1501
Fig. 5

1.2 mm



30.1504
Fig. 14

1 mm



30.1507
Fig. 17

1.2 mm



30.1510
Fig. 18

1.6 mm



30.1513
Fig. 19

2 mm



30.1516
Fig. 20

- Экскаваторы
 - Excavateurs
 - Excavatoren
- Экскаватори
 - Excavadores
 - حفارات

ASH, Darby-Perry Excavators

1 mm



30.1519
Fig. 243
ASH

1.4 mm



30.1522
Fig. G2
ASH

0.8 mm



30.1525
Fig. 1
Darby-Perry

0.8 mm



30.1528
Fig. 2
Darby-Perry

1 mm



30.1531
Fig. 11
Darby-Perry

1 mm



30.1534
Fig. 12
Darby-Perry

1.2 mm



30.1537
Fig. 21
Darby-Perry

1.2 mm



30.1540
Fig. 22
Darby-Perry

1.6 mm



30.1543
Fig. 31
Darby-Perry

1.6 mm



30.1546
Fig. 32
Darby-Perry

2 mm



30.1549
Fig. 41
Darby-Perry

2 mm



30.1552
Fig. 42
Darby-Perry

BONE CURETTES

- Кюрети
- Curettes tranchantes
- Scharfe Löffel

- Кюрети
- Curetas cortantes
- كرتس العظام

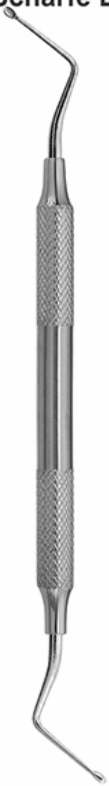

30.1555
Fig. 1
Hemingway



30.1558
Fig. 2
Hemingway



30.1561
Fig. 3
Hemingway



30.1564
Fig. 4
Hemingway

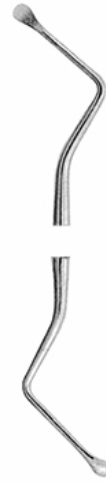

30.1567
Fig. 85
Lucas



30.1570
Fig. 86
Lucas

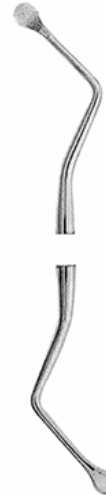

30.1573
Fig. 87
Lucas

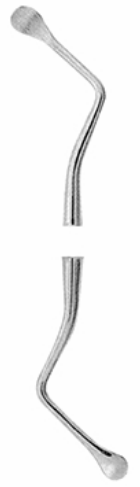

30.1576
Fig. 88
Lucas



30-1579
Fig. 1
Hemingway



30.1582
Fig. 2
Hemingway



30.1585
Fig. 3
Hemingway



30.1588
Fig. 4
Hemingway

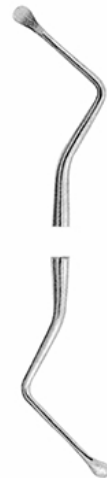

30.1591
Fig. 85
Lucas

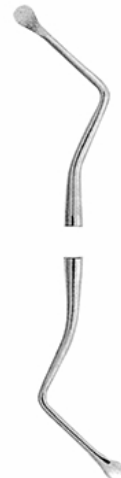

30.1594
Fig. 86
Lucas

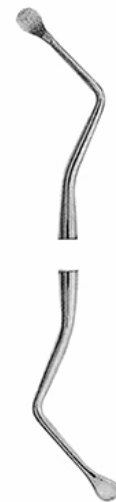

30.1597
Fig. 87
Lucas



30.1600
Fig. 88
Lucas

- Инструменты пародонтологические
- Instruments pour la parodontologie
- Instrumente für die Parodontologie

- Інструменти пародонтологічні
- instrumentos para periodoncia
- الصكوك اللثة

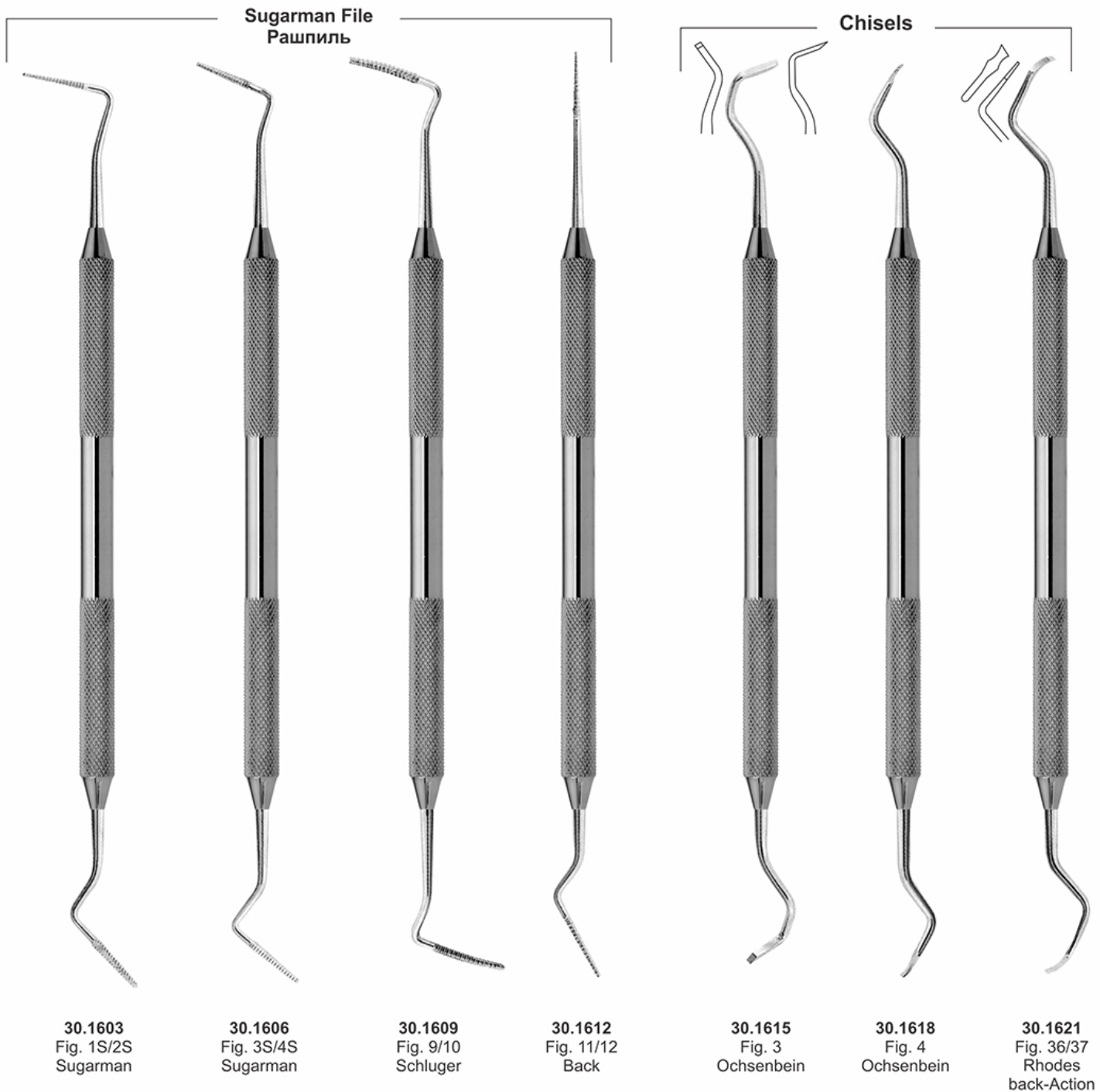

- Инструменты пародонтологические
- Instruments pour la parodontologie
- Instrumente für die Parodontologie

- Інструменти пародонтологічні
- instrumentos para periodoncia
- الصكوك اللثة

Sugarman File Рашпиль

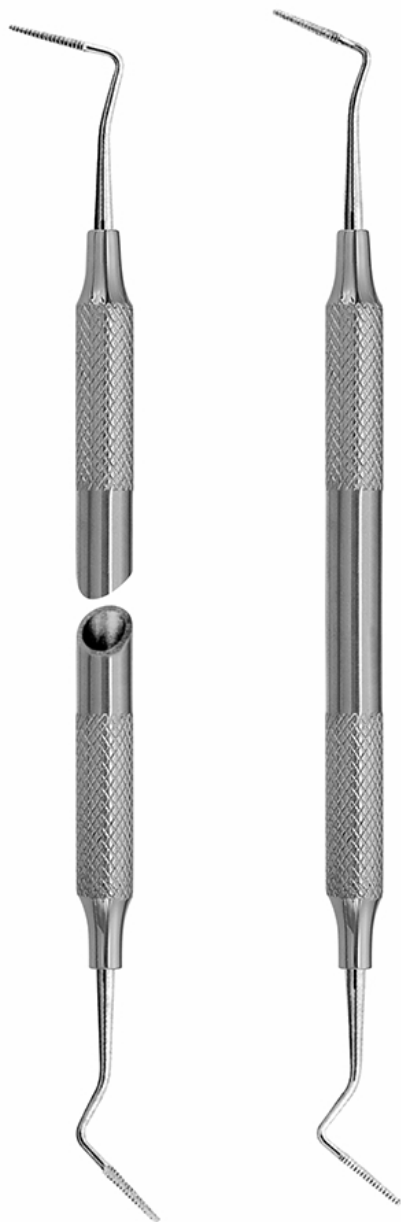

30.1624
Fig. 1S/2S
Sugarman

30.1627
Fig. 3S/4S
Sugarman

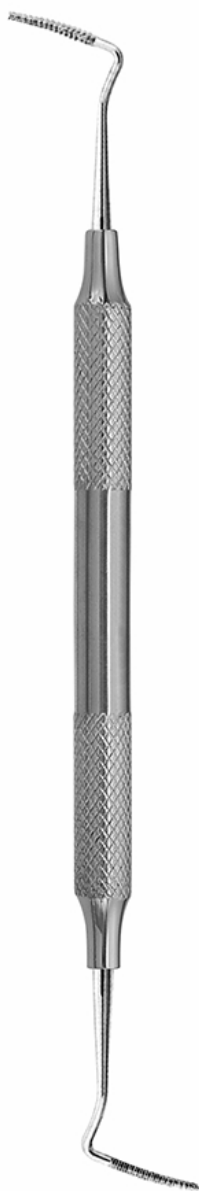

30.1630
Fig. 9/10
Schluger

Ochsenbein Chisels File Ochsenbein Рашпиль Долота



30.1633
Fig. 3
Ochsenbein

30.1636
Fig. 4
Ochsenbein

30.1639
Fig. 36/37
Rhodes Back-Action
Зворотної дії

- Инструменты пародонтологические
- Instruments pour la parodontologie
- Instrumente für die Parodontologie

- Інструменти пародонтологічні
- instrumentos para periodoncia
- الصكوك اللثة

Chisels - Долота



30.1642
Fig. 1/2
TG Chisel

30.1645
Fig. 1/2
TG Chisel

30.1648
Fig. 1
TG Chisel

30.1651
Fig. 2
TG Chisel

Gingivectomy Knives Ножі для гінгівектомії



30.1654
Fig. 1
(15K) Kirkland

30.1657
Fig. 2
(16K) Kirkland

- Инструменты пародонтологические
- Instruments pour la parodontologie
- Instrumente für die Parodontologie
- Инструменти пародонтологічні
- instrumentos para periodoncia
- الصكوك اللثة

Gingivectomy Knives

Ножі для гінгівектомії

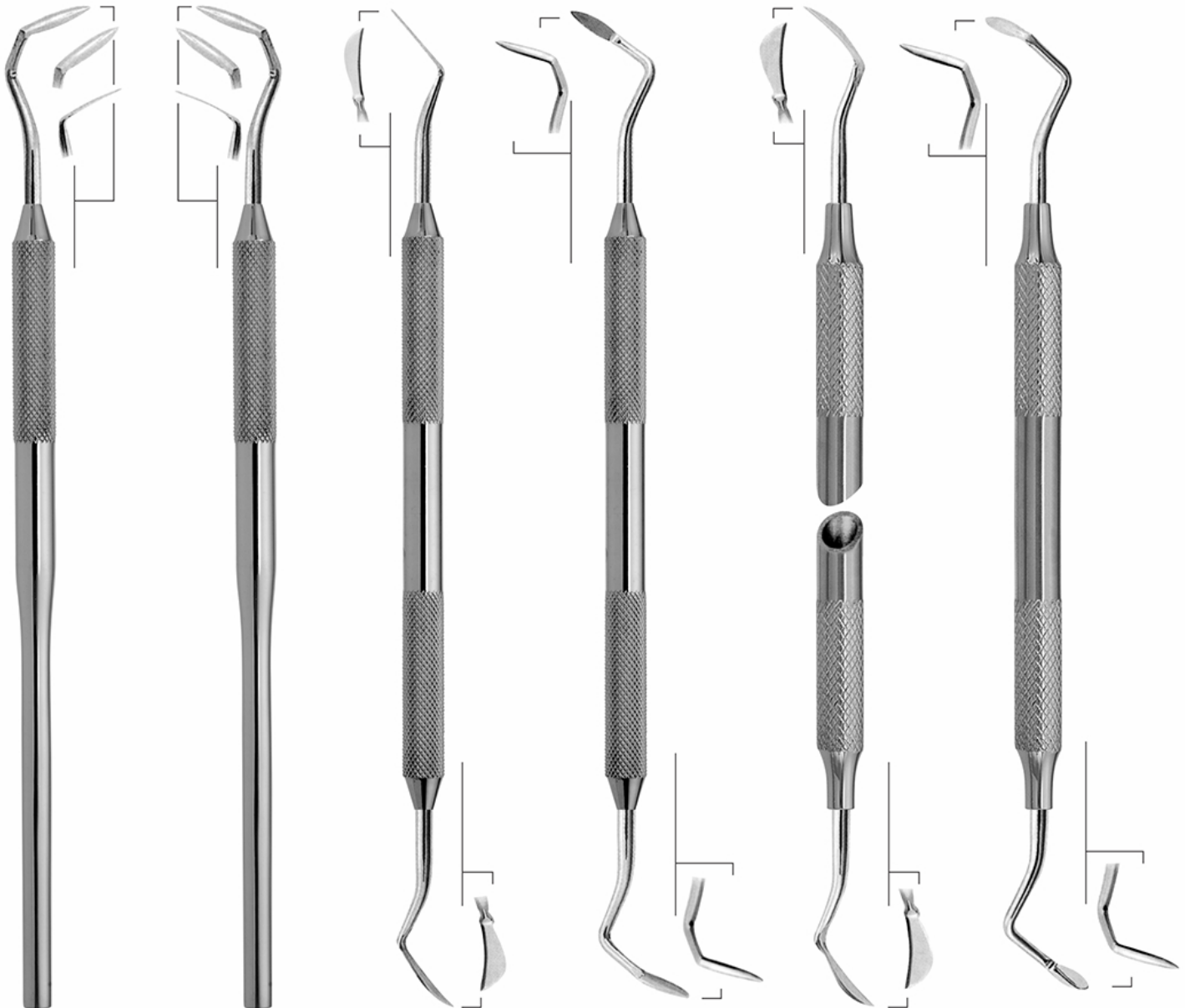

30.1660
Fig. 1
Orban

30.1663
Fig. 2
Orban

30.1666
Fig. 1/2
(15k/16k)
Kirkland

30.1669
Fig. 1/2
Orban

30.1672
Fig. 1/2
(15k/16k)
Kirkland

30.1675
Fig. 1/2
Orban



- Инструменты пародонтологические
- Instruments pour la parodontologie
- Instrumente für die Parodontologie

- Інструменти пародонтологічні
- instrumentos para periodoncia
- الصكوك اللثة

Gingivectomy Knives

Ножі для гінгівектомії

Goldman Fox Gingivectomy Knife

Goldman-Fox Ніж для гінгівектомії

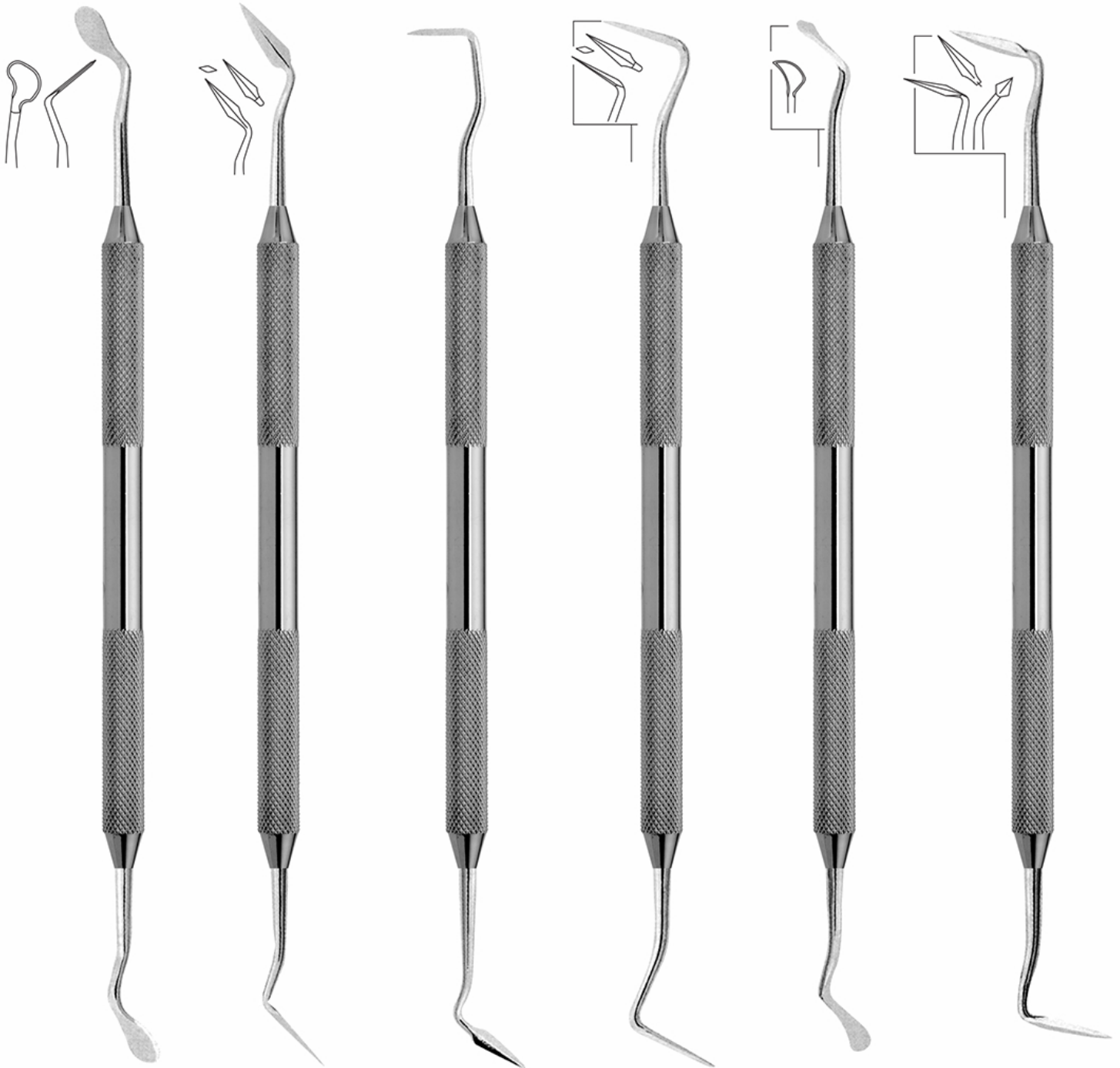

30.1678
Fig. 7
Goldman-Fox

30.1681
Fig. 8
Goldman-Fox

30.1684
Fig. 9
Goldman-Fox

30.1687
Fig. 11
Goldman-Fox

30.1690
Fig. 3/4
Buck

30.1693
Fig. 5/6
Buck

- Инструменты пародонтологические
- Instruments pour la parodontologie
- Instrumente für die Parodontologie
- Інструменти пародонтологічні
- instrumentos para periodoncia
- الصكوك اللثة

Gingivectomy Knives Ножи для гінгівектомії

Goldman-Fox Ніж для гінгівектомії

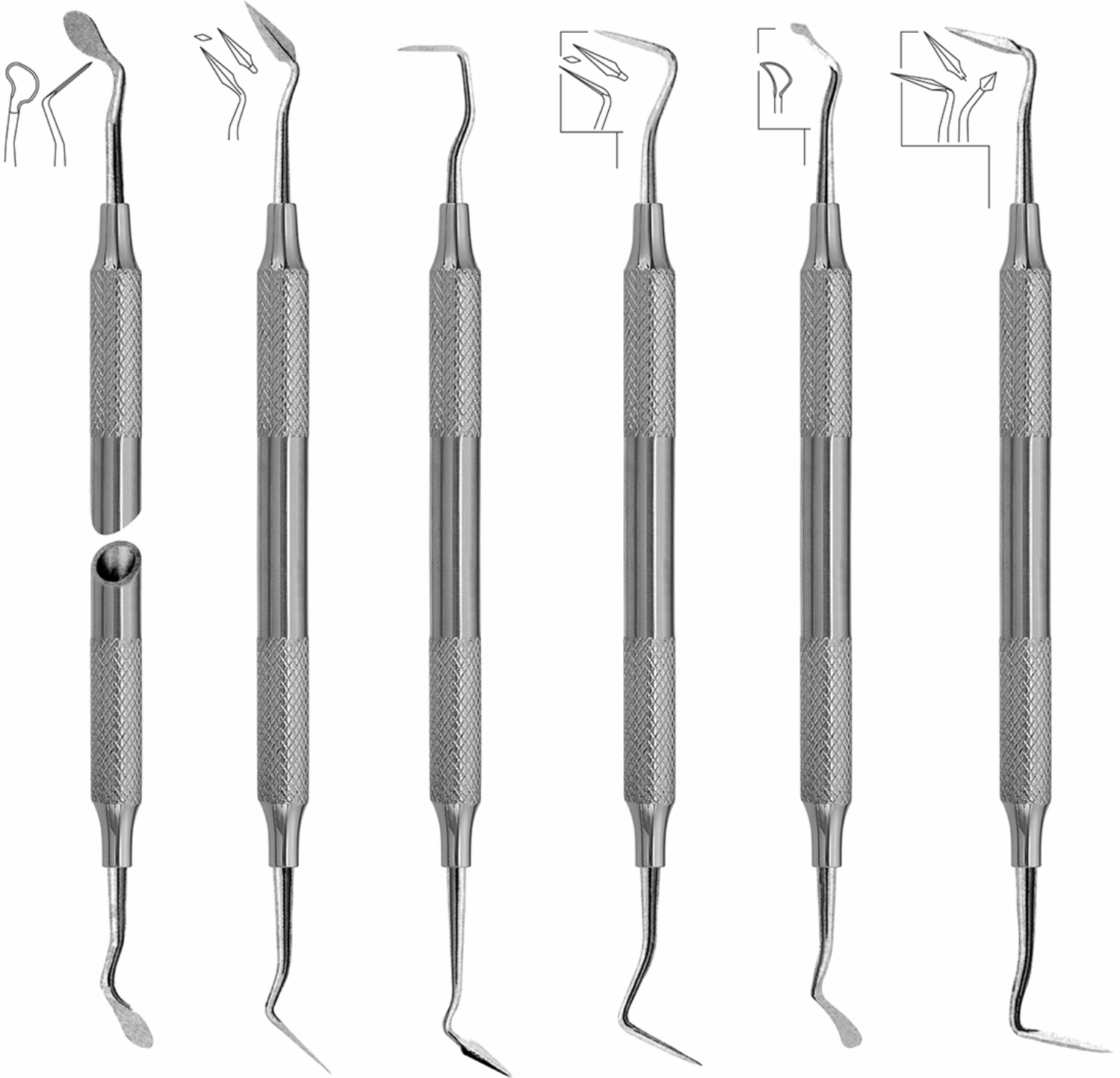

30.1696
Fig. 7
Goldman-Fox

30.1699
Fig. 8
Goldman-Fox

30.1702
Fig. 9
Goldman-Fox

30.1705
Fig. 11
Goldman-Fox

30.1708
Fig. 3/4
Buck

30.1711
Fig. 5/6
Buck



- Инструменты пародонтологические
- Instruments pour la parodontologie
- Instrumente für die Parodontologie

- Інструменти пародонтологічні
- instrumentos para periodoncia
- الصكوك اللثة

Gingivectomy Knives Ножі для гінгівектомії

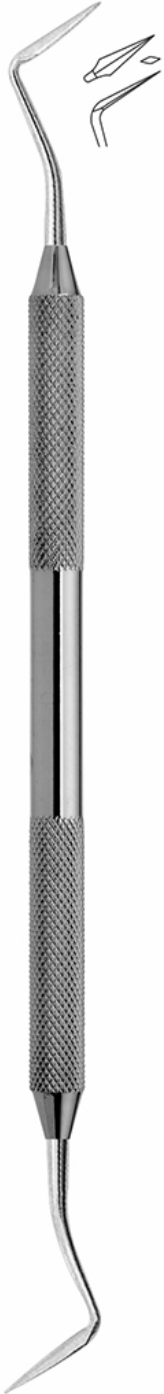

30.1714
Fig. 1/2
Sanders



30.1717
Fig. 4/5
Sanders

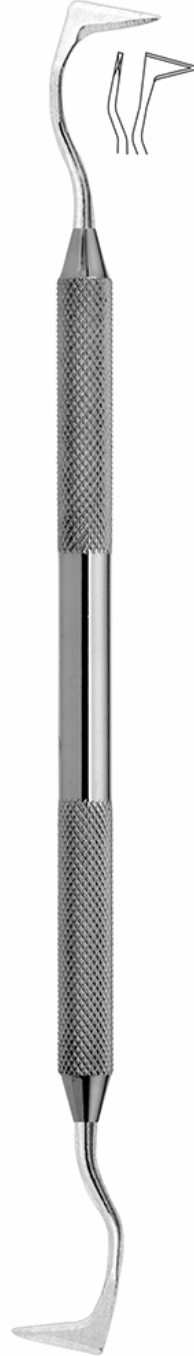

30.1720
Fig. 19/20
(University of
South California)
USC Towner

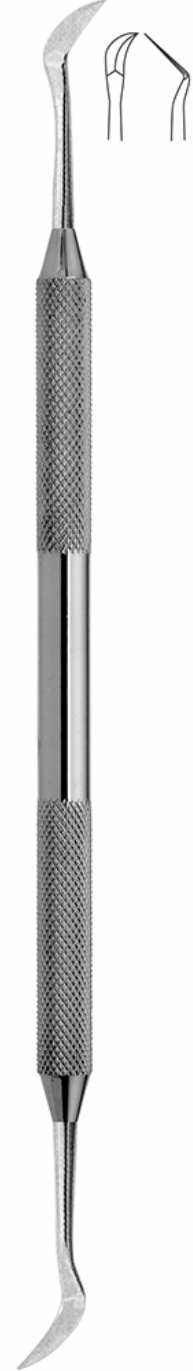

30.1723
Fig. CK3
Crane-Kaplan

- Инструменты пародонтологические
 - Instruments pour la parodontologie
 - Instrumente für die Parodontologie
- Інструменти пародонтологічні
 - instrumentos para periodoncia
 - الصكوك اللثة

Curettes & Scalers

Кюретки і інструменти для видалення зубного каменя

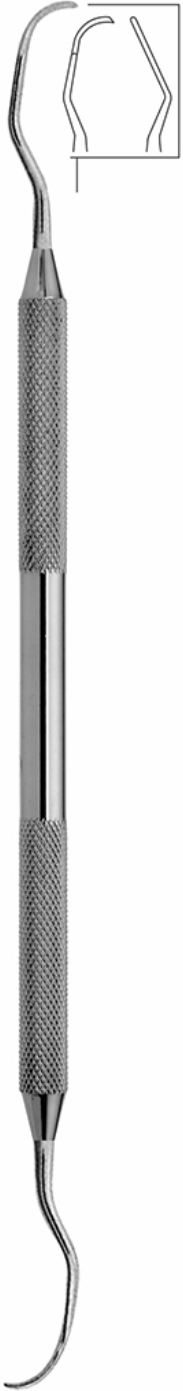

30.1726
Fig. HU 1/2
Langer

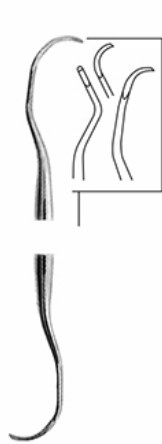

30.1729
Fig. 3/4
Langer



30.1732
Fig. 1/2
Barnhart



30.1735
Fig. 5/6
Barnhart

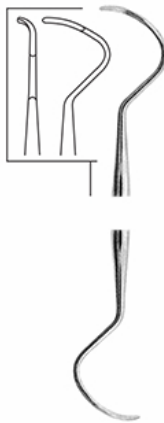

30.1738
Fig. ME-1
(10/11)



30.1741
Fig. 3/4
Rule (23/24)

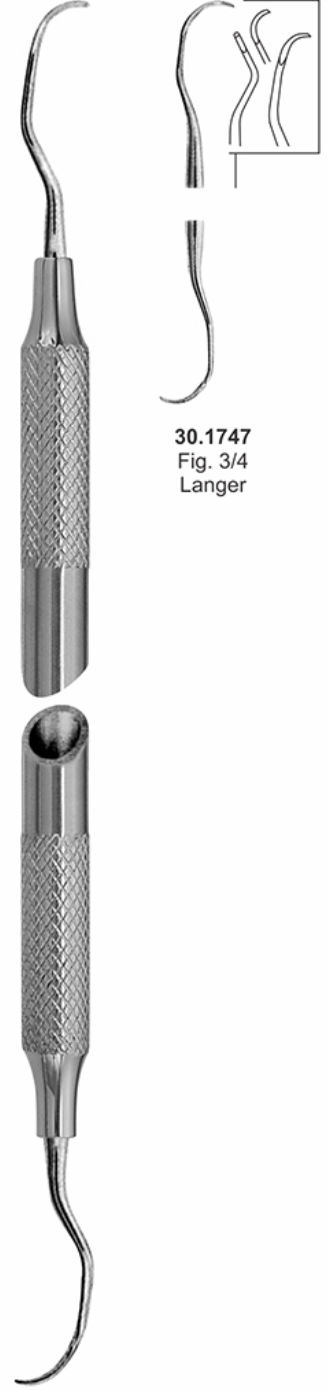

30.1744
Fig. HU 1/2
Langer

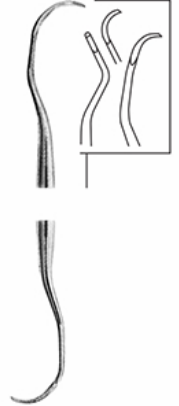

30.1747
Fig. 3/4
Langer

- Инструменты пародонтологические
- Instruments pour la parodontologie
- Instrumente für die Parodontologie
- Інструменти пародонтологічні
- instrumentos para periodoncia
- الصكوك اللثة

Curettes & Scalers

Zerjing-Chisel - with Straight Working Tip

(Manual Tartar Removal From Interior Teeth Sacs)

Кюретки і інструменти для видалення зубного каменя
 Zerjing-Долото – з прямими робочими наконечниками
 (Ручне видалення зубного нальоту з внутрішніх зубних мішків)

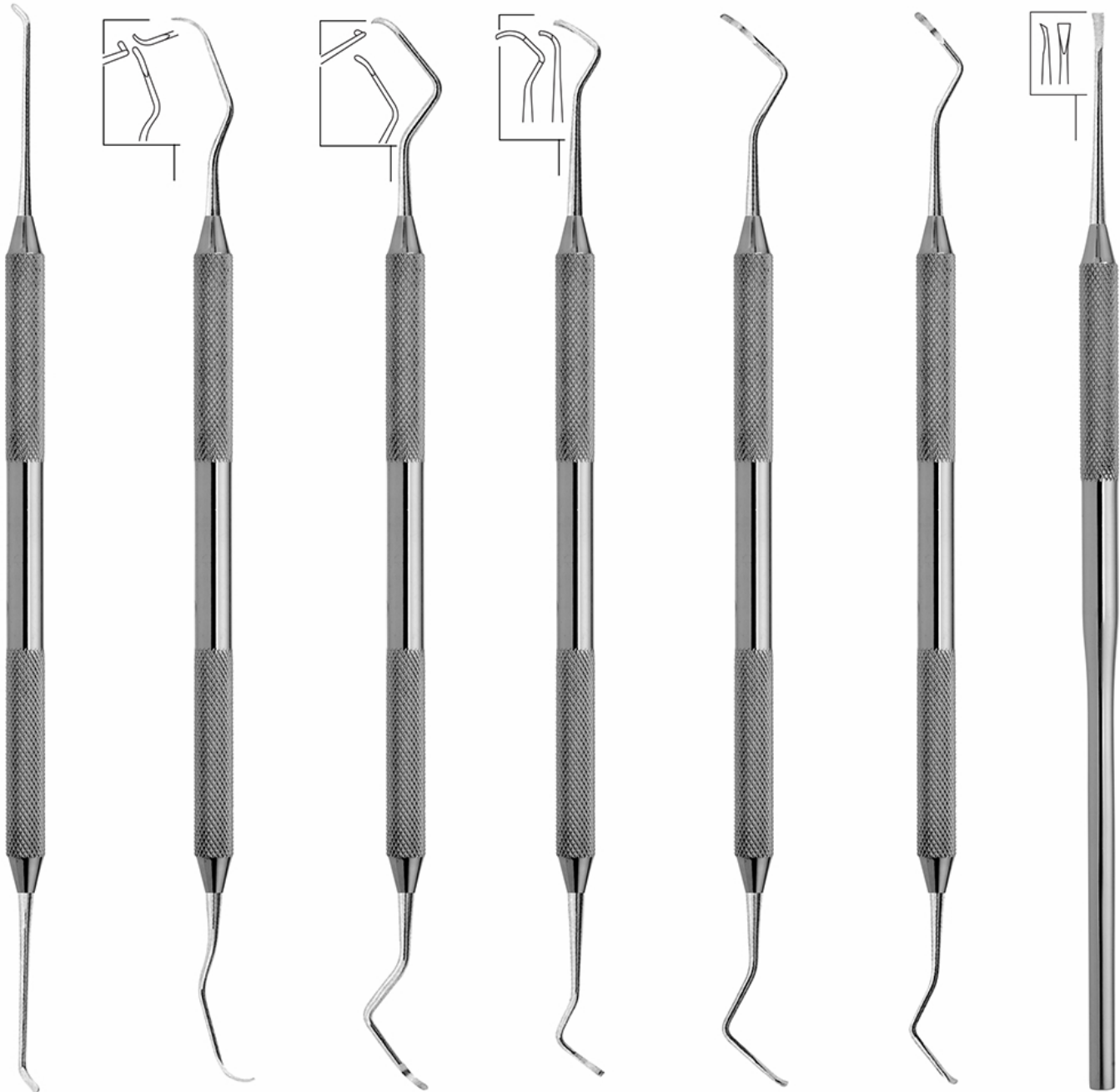

30.1750
Fig. HU 1/2
Curette

30.1753
Fig. 2R/2L
Columbia
Кюретка

30.1756
Fig. 4R/4L
Columbia
Кюретка

30.1759
Fig. 13/14
Columbia
Кюретка

30.1762
Fig. 411/412

30.1765
Fig. 413/414

30.1768
Zerjing-Chisel
Долото

- Инструменты пародонтологические
- Instruments pour la parodontologie
- Instrumente für die Parodontologie
- Инструменти пародонтологічні
- instrumentos para periodoncia
- الصكوك اللثة

Curettes & Scalers

Кюретки і Інструменти для видалення зубного каменя

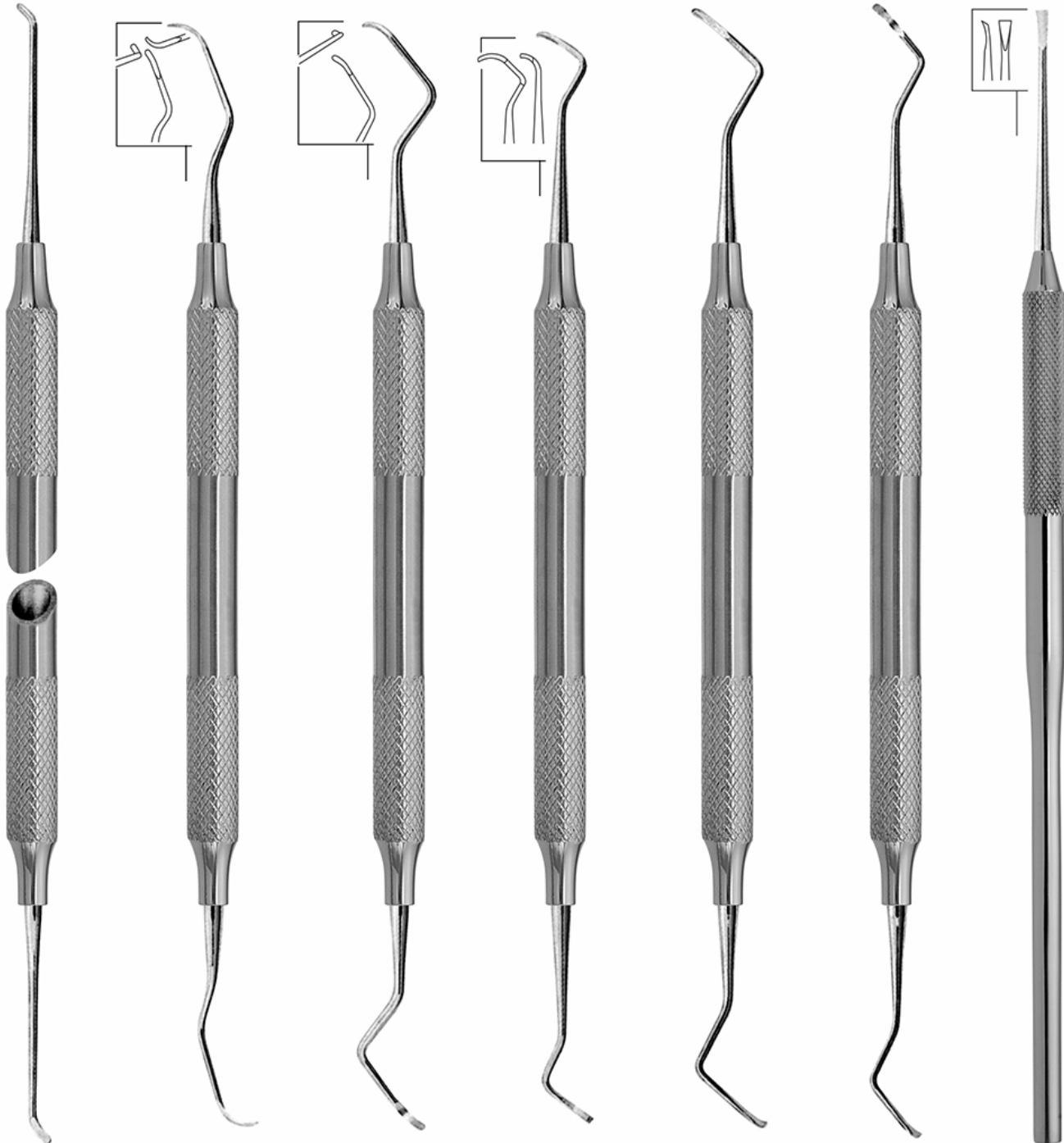

30.1771
Fig. HU 1/2
Curette

30.1774
Fig. 2R/2L
Columbia
Кюретка

30.1777
Fig. 4R/4L
Columbia
Кюретка

30.1780
Fig. 13/14
Columbia
Кюретка

30.1783
Fig. 411/412

30.1786
Fig. 413/414

30.1789
Zerfing-Chisel

- Инструменты пародонтологические
- Instruments pour la parodontologie
- Instrumente für die Parodontologie

- Інструменти пародонтологічні
- instrumentos para periodoncia
- الصكوك اللثة

Curettes & Scalers

Кюретки і Інструменти для видалення зубного каменя

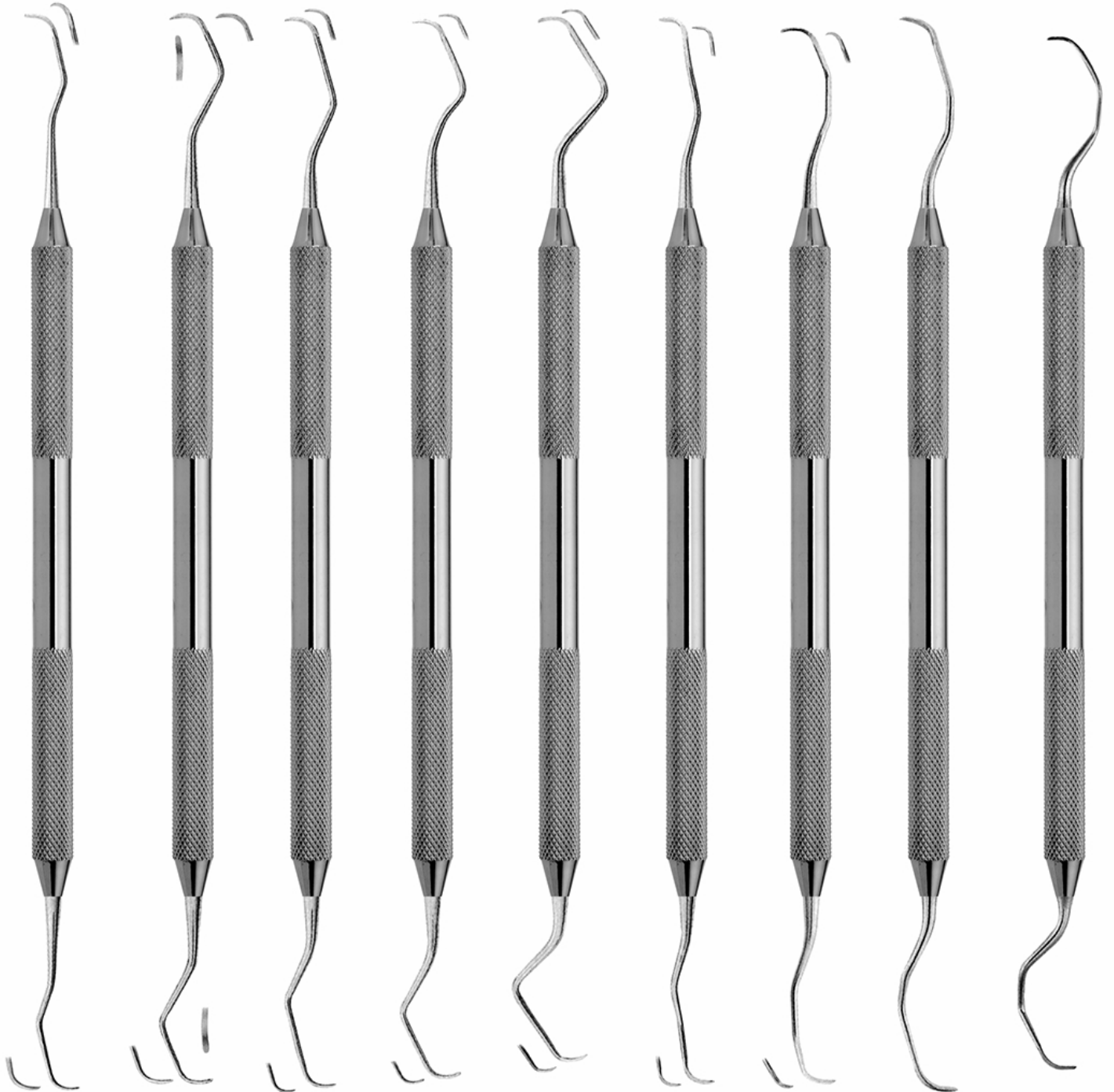

30.1792
Fig. Рис. 1/2
Gracey
Серединно-дистальний

30.1795
Fig. Рис. 3/4
Gracey
Серединно-дистальний

30.1798
Fig. Рис. 5/6
Gracey
Серединно-дистальний

30.1801
Fig. Рис. 7/8
Gracey
Серединно-дистальний

30.1804
Fig. Рис. 9/10
Gracey
Серединно-дистальний

330.1807
Fig. Рис. 11/12
Gracey
Серединно-дистальний

30.1810
Fig. Рис. 13/14
Gracey
Серединно-дистальний

30.1813
Fig. Рис. 15/16
Gracey
Серединно-дистальний

30.1816
Fig. Рис. 17/18
Gracey
Серединно-дистальний

- Инструменты пародонтологические
- Instruments pour la parodontologie
- Instrumente für die Parodontologie
- Инструменти пародонтологічні
- instrumentos para periodoncia
- الصكوك اللثة

Curettes and Scalers

Кюретки і Інструменти для видалення зубного каменя

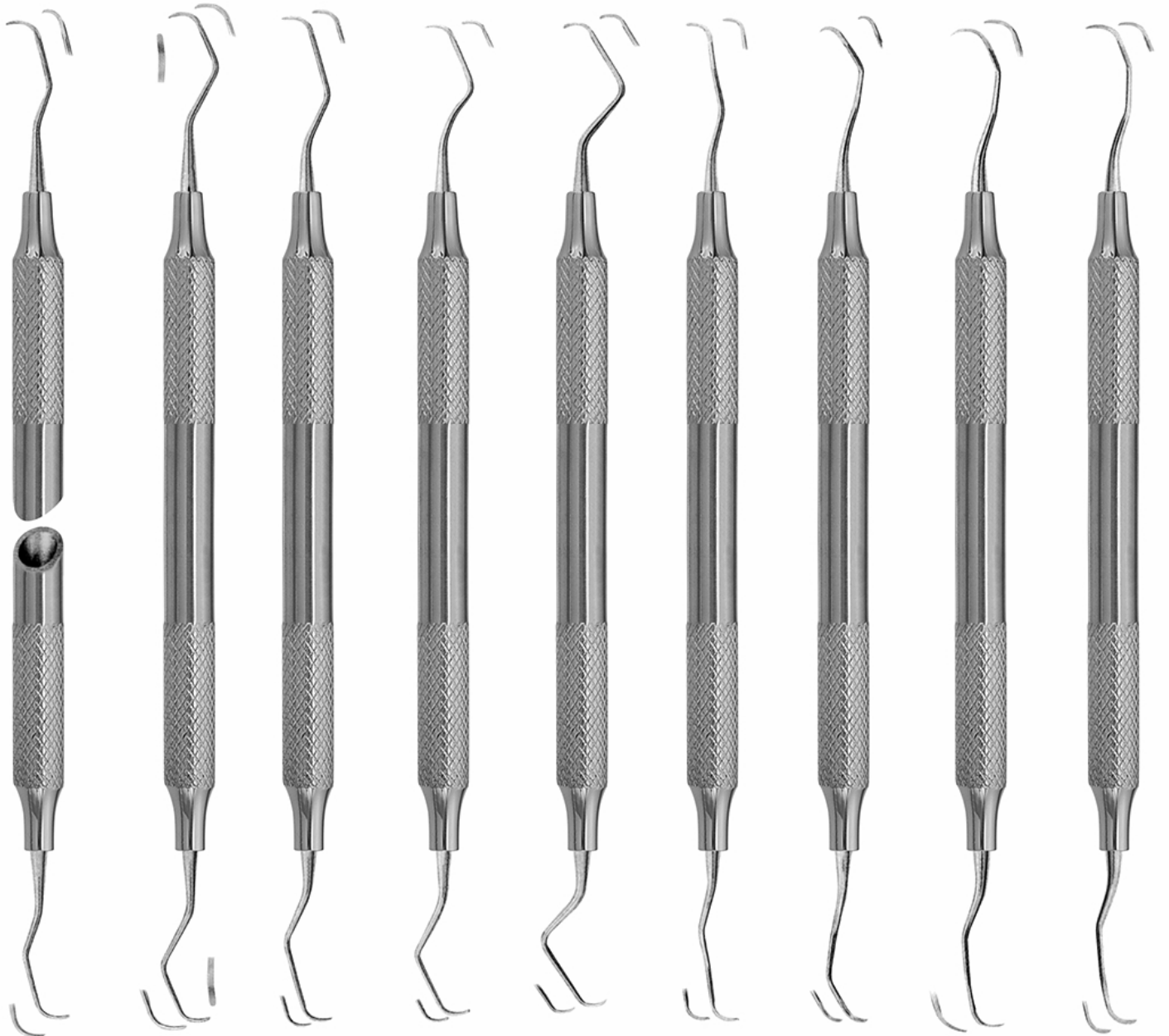

30.1819
Fig. 1/2
Gracey
Серединно-дистальний

30.1822
Fig. 3/4
Gracey
Серединно-дистальний

30.1825
Fig. 5/6
Gracey
Серединно-дистальний

30.1828
Fig. 7/8
Gracey
Серединно-дистальний

30.1831
Fig. 9/10
Gracey
Серединно-дистальний

30.1834
Fig. 11/12
Gracey
Серединно-дистальний

30.1837
Fig. 13/14
Gracey
Серединно-дистальний

30.1840
Fig. 11/14
Gracey
Mesial-Distal

30.1843
Fig. 12/13
Gracey
Mesial-Distal



- Инструменты пародонтологические
- Instruments pour la parodontologie
- Instrumente für die Parodontologie

- Інструменти пародонтологічні
- instrumentos para periodoncia
- الصكوك اللثة

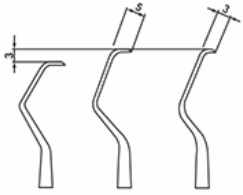

Gracey Gracey AF Gracey MF

Gracey Curettes AF Type (AfterFive)
Gracey Кюретки Af тип (більше п'яти)

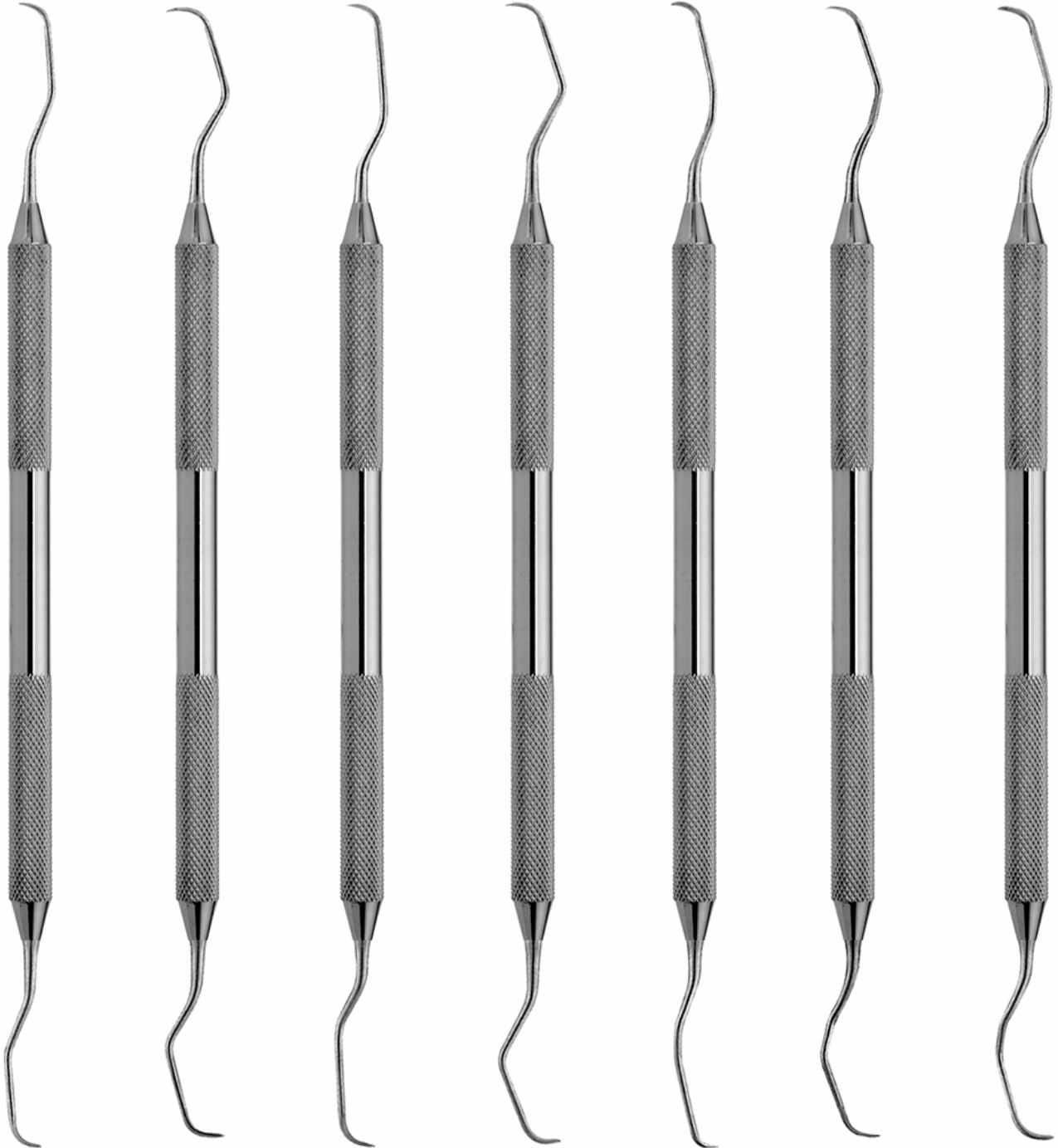

30.1846
Fig. 1/2
Gracey
AF/Type

30.1849
Fig. 3/4
Gracey
AF/Type

30.1852
Fig. 5/6
Gracey
AF/Type

30.1855
Fig. 7/8
Gracey
AF/Type

30.1858
Fig. 11/12
Gracey
AF/Type

30.1861
Fig. 13/14
Gracey
AF/Type

30.1864
Fig. 15/16
Gracey
AF/Type

- Инструменты пародонтологические
- Instruments pour la parodontologie
- Instrumente für die Parodontologie

- Інструменти пародонтологічні
- instrumentos para periodoncia
- الصكوك اللثة

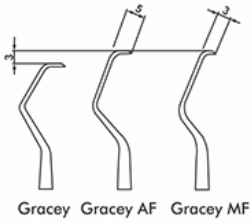

Gracey Curettes MF Type (MiniFive)
Gracey Кюретки Mf Type (мінімальна п'ятірка)

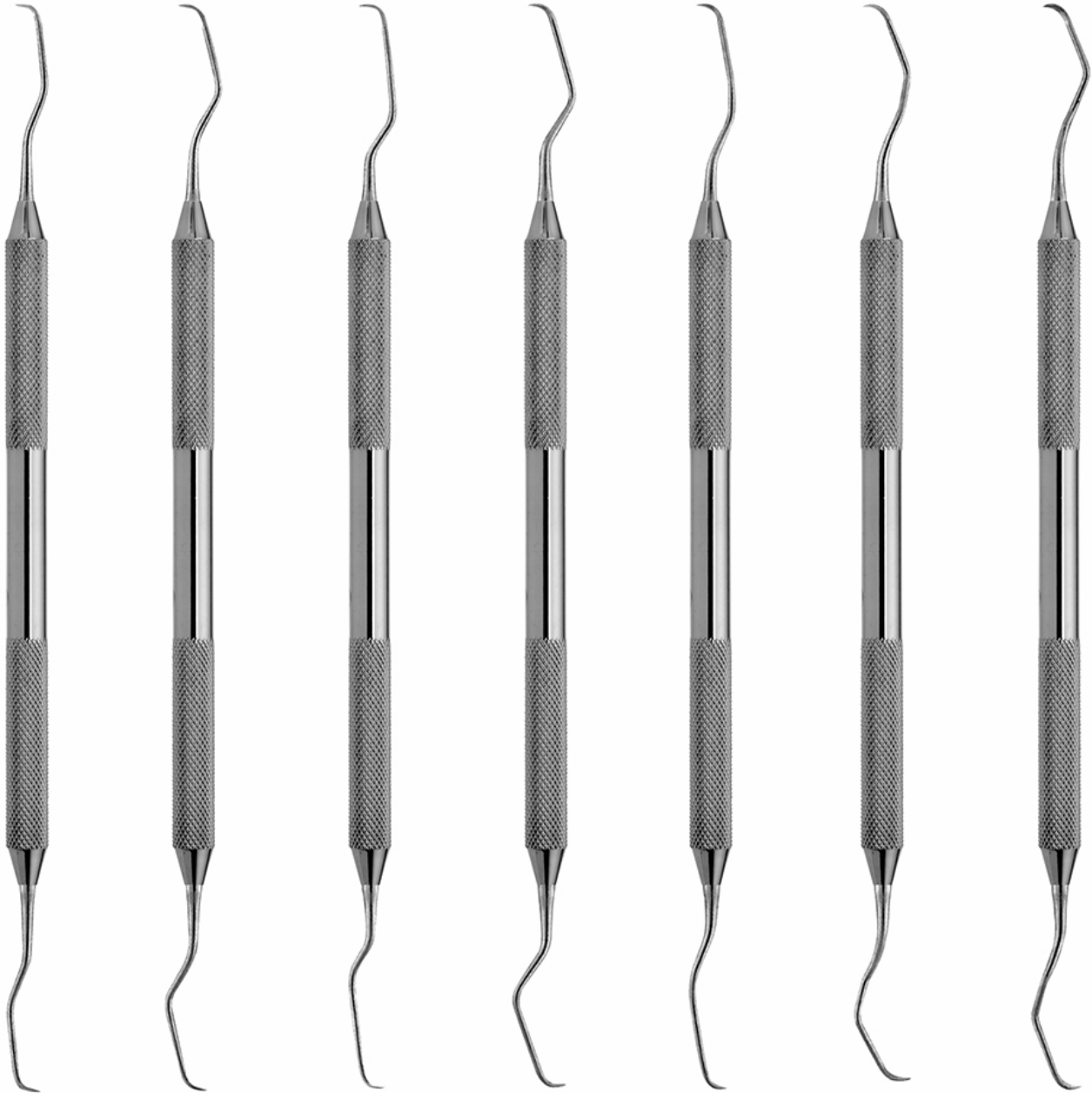

30.1867
Fig. 1/2
Gracey
MF/Type

30.1870
Fig. 3/4
Gracey
MF/Type

30.1873
Fig. 5/6
Gracey
MF/Type

30.1876
Fig. 7/8
Gracey
MF/Type

30.1879
Fig. 11/12
Gracey
MF/Type

30.1882
Fig. 13/14
Gracey
MF/Type

30.1885
Fig. 15/16
Gracey
MF/Type

- Инструменты пародонтологические
- Instruments pour la parodontologie
- Instrumente für die Parodontologie

- Інструменти пародонтологічні
- instrumentos para periodoncia
- الصكوك اللثة

Curettes & Scalers

Кюретки і інструменти для видалення зубного каменя

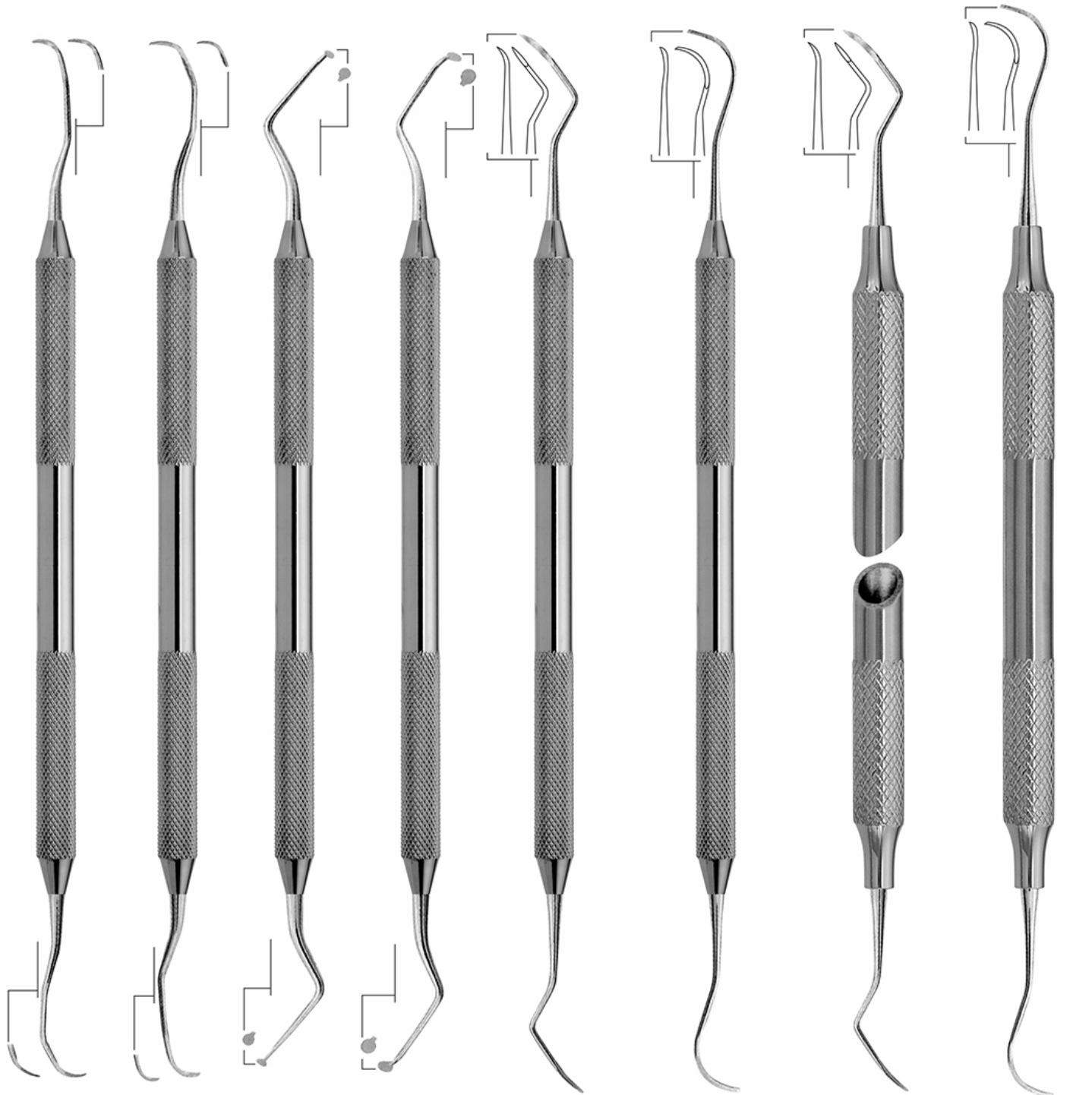

30.1888
Fig. 11/14
Gracey
Mesial-Distal
Серединно-
дистальний

30.1891
Fig. 12/13
Gracey
Mesial-Distal
Серединно-
дистальний

30.1894
Fig. 1
De Marco

30.1897
Fig. 2
De Marco

30.1900
Fig. 13/14
Indiana University
Anterior
передній ряд

30.1903
Fig. 17/18
Indiana University
Posterior
задній ряд

30.1906
Fig. 13/14
Indiana University
Anterior
передній ряд

30.1909
Fig. 17/18
Indiana University
Posterior
задній ряд

- Инструменты пародонтологические
- Instruments pour la parodontologie
- Instrumente für die Parodontologie
- Інструменти пародонтологічні
- instrumentos para periodoncia
- الصكوك اللثة

Curettes & Scalers

Кюретки і інструменти для видалення зубного каменя

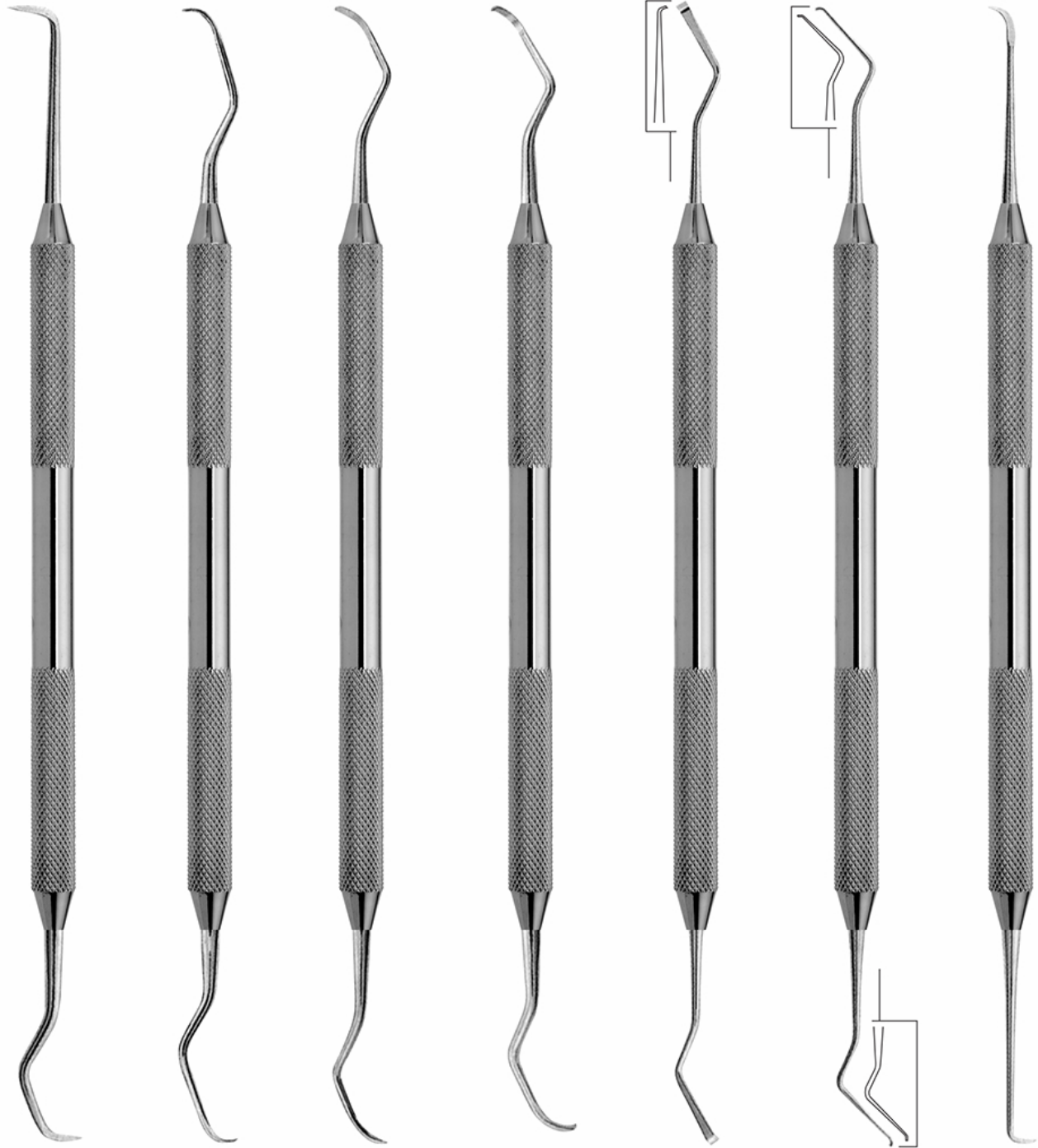

30.1912
Fig. 1
Goldman-Fox

30.1915
Fig. 2
Goldman-Fox

30.1918
Fig. 3
Goldman-Fox

30.1921
Fig. 4
Goldman-Fox

30.1924
Fig. 5
Goldman-Fox

30.1927
Fig. 6
Goldman-Fox

30.1930
Fig. 21
Goldman-Fox

- Инструменты пародонтологические
 - Instruments pour la parodontologie
 - Instrumente für die Parodontologie
- Інструменти пародонтологічні
 - instrumentos para periodoncia
 - الصكوك اللثة

Curettes & Scalers

Кюретки і інструменти для видалення зубного каменя

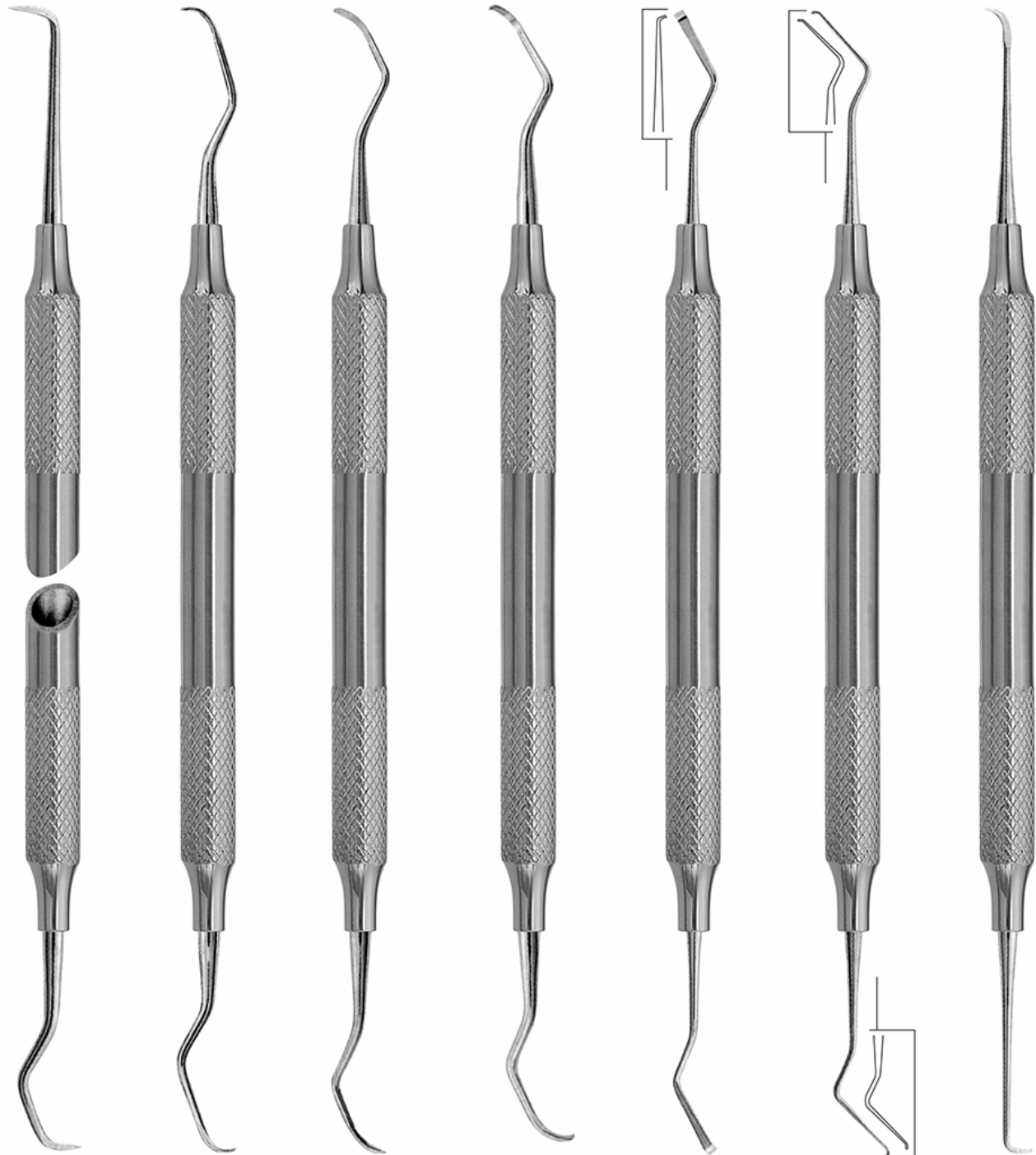

30.1933
Fig. 1
Goldman-Fox

30.1936
Fig. 2
Goldman-Fox

30.1939
Fig. 3
Goldman-Fox

30.1942
Fig. 4
Goldman-Fox

30.1945
Fig. 5
Goldman-Fox

30.1948
Fig. 6
Goldman-Fox

30.1951
Fig. 21
Goldman-Fox

- Инструменты пародонтологические
- Instruments pour la parodontologie
- Instrumente für die Parodontologie
- Инструменти пародонтологічні
- instrumentos para periodoncia
- الصكوك اللثة

Curettes & Scalers

Кюретки і інструменти для видалення зубного каменя

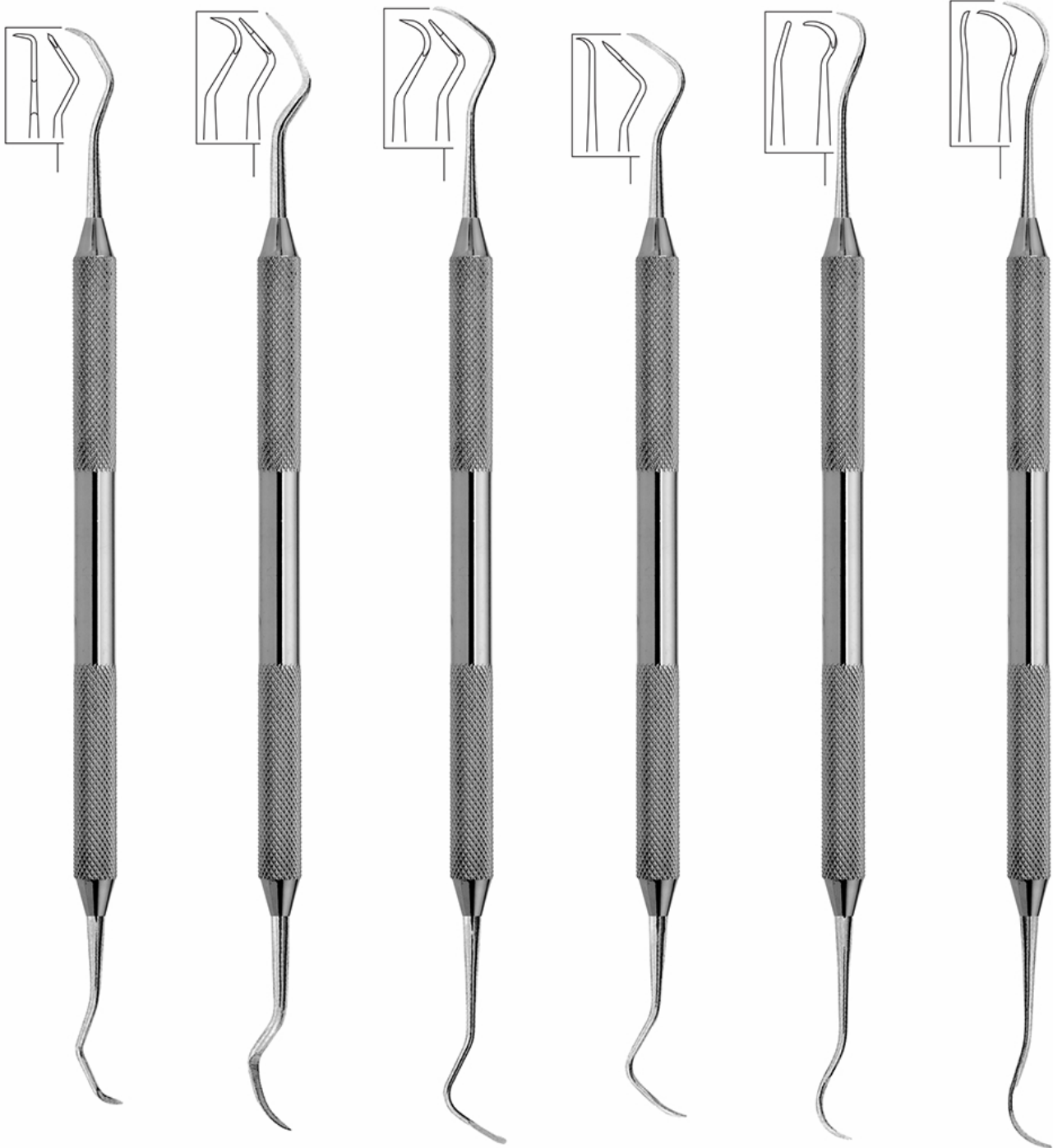

30.1954
Fig. 11/12
Mc Call

30.1957
Fig. 11A/12A
Mc Call

30.1960
Fig. 13/14
Mc Call

30.1963
Fig. 13S/14S
Mc Call

30.1966
Fig. 17S/18S
Mc Call

30.1969
Fig. 19/20
Mc Call



- Инструменты пародонтологические
- Instruments pour la parodontologie
- Instrumente für die Parodontologie

- Інструменти пародонтологічні
- instrumentos para periodoncia
- الصكوك اللثة

Curettes & Scalers

Кюретки і інструменти для видалення зубного каменя

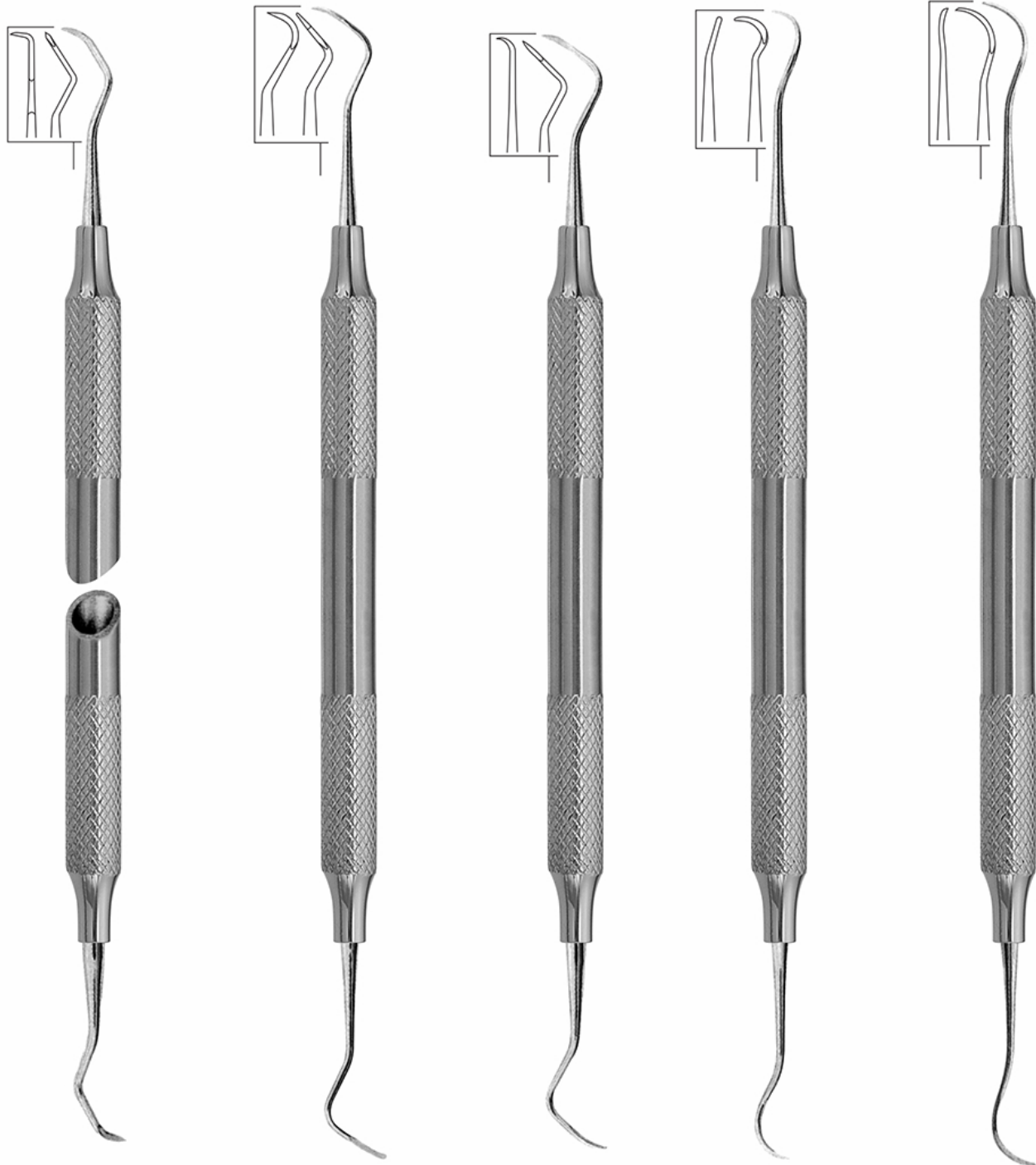

30.1972
Fig. 11/12
Mc Call

30.1975
Fig. 13/14
Mc Call

30.1978
Fig. 13S/14S
Mc Call

30.1981
Fig. 17S/18S
Mc Call z

30.1984
Fig. 19/20
Mc Call

- Инструменты пародонтологические
 - Instruments pour la parodontologie
 - Instrumente für die Parodontologie
- Інструменти пародонтологічні
 - instrumentos para periodoncia
 - الصكوك اللثة

Curettes & Scalers Scaler for manual removal of over-gingival backside tartar

Кюретки і інструменти для видалення зубного каменя Скалер для ручного видалення over-gingival backside tartar

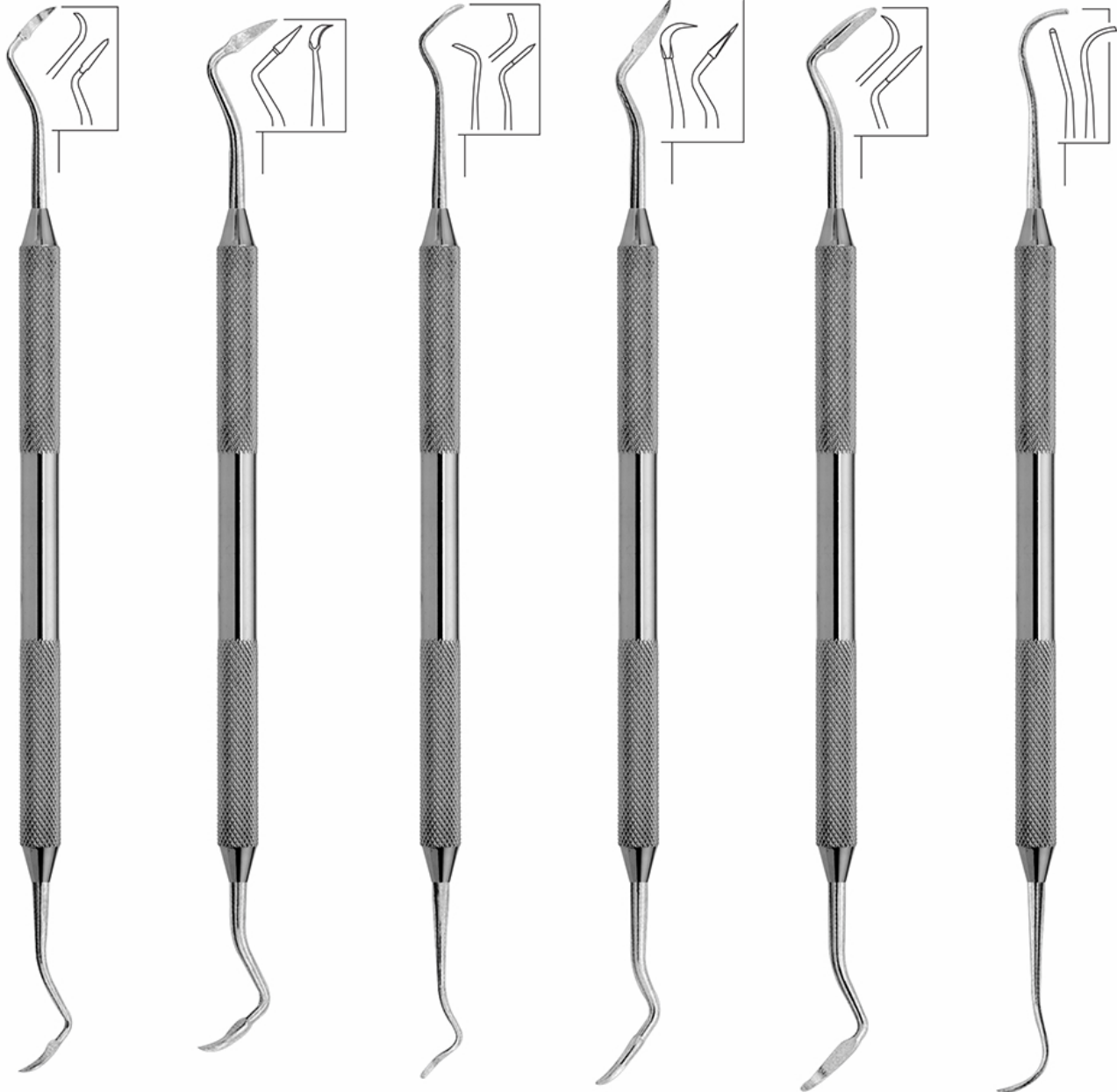

30.1987
Fig. 2/3
Taylor

30.1990
Fig. 204

30.1993
Fig. 204S

30.1996
Fig. 2/3

30.1999
Fig. 6
Crane-Kaplan

30.2002
Fig. 7/8
Younger-Good



- Инструменты пародонтологические
- Instruments pour la parodontologie
- Instrumente für die Parodontologie

- Інструменти пародонтологічні
- instrumentos para periodoncia
- الصكوك اللثة

Curettes & Scalers

Кюретки і інструменти для видалення зубного каменя

Curettes & Scalers Hirschfeld File

Кюретки і інструменти для видалення зубного каменя Hirschfeld Рашиль

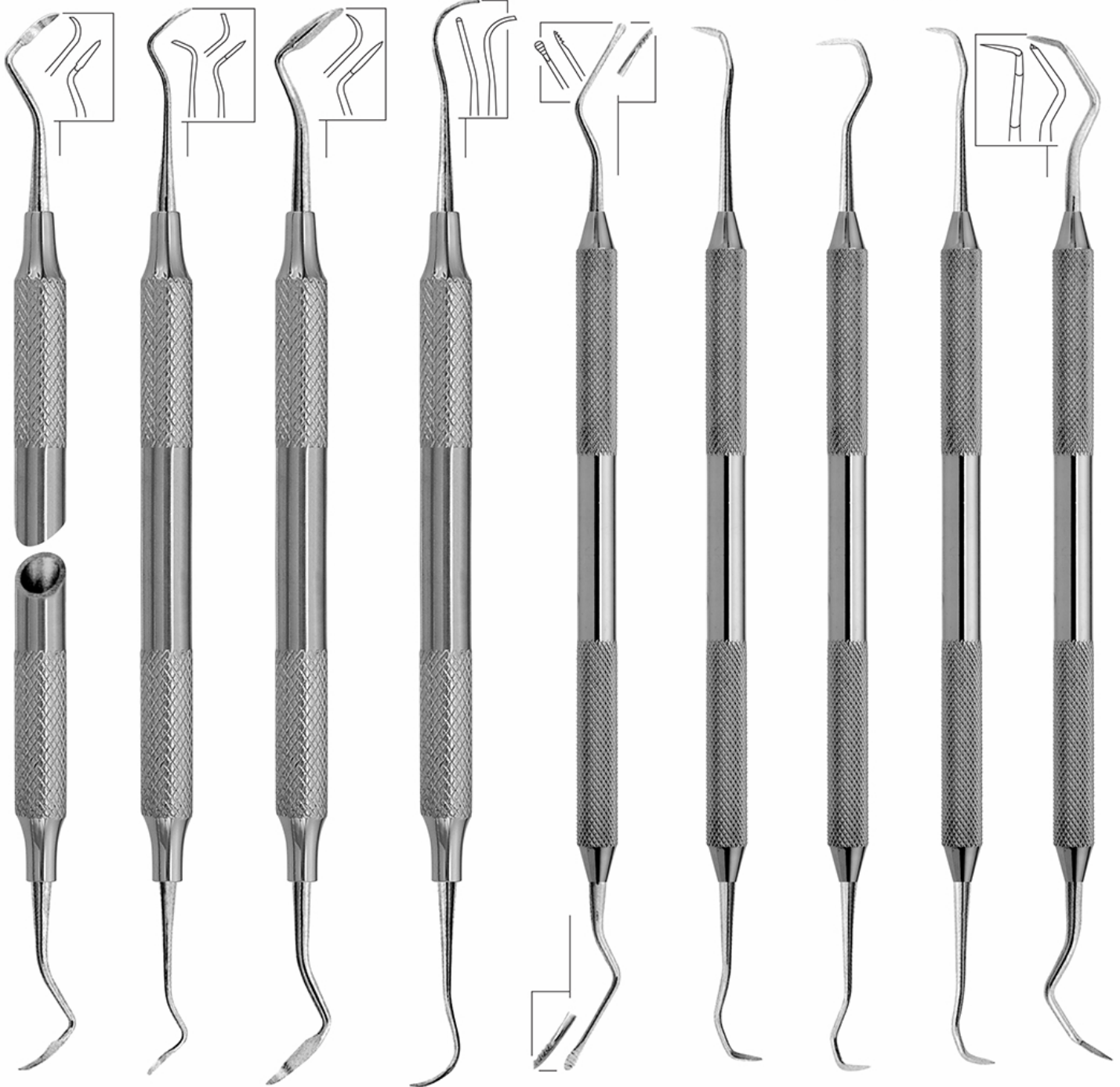

30.2005
Fig. 2/3
Taylor

30.2008
Fig. 204S

30.2011
Fig. 6
Crane-Kaplan

30.2014
Fig. 7/8
Younger-Good

30.2017
Fig. 3/7
Hirschfeld

30.2020
Fig. 31/32
Jacquette

30.2023
Fig. 30/33
Jacquette

30.2026
Fig. 34/35
Jacquette

30.2029
Fig. 37/38
Jacquette

- Инструменты пародонтологические
- Instruments pour la parodontologie
- Instrumente für die Parodontologie
- Инструменти пародонтологічні
- instrumentos para periodoncia
- الصكوك اللثة

Curettes & Scalers

Кюретки і інструменти для видалення зубного каменя



30.2032
Fig. 3/7
Hirschfeld



30.2035
Fig. 31/32
Jacquette



30.2038
Fig. 30/33
Jacquette



30.2041
Fig. 34/35
Jacquette



30.2044
Fig. 37/38
Jacquette

- Инструменты пародонтологические
- Instruments pour la parodontologie
- Instrumente für die Parodontologie

- Інструменти пародонтологічні
- instrumentos para periodoncia
- الصكوك اللثة

Scaler For Tartar Removal

Скалер для видалення зубного нальоту

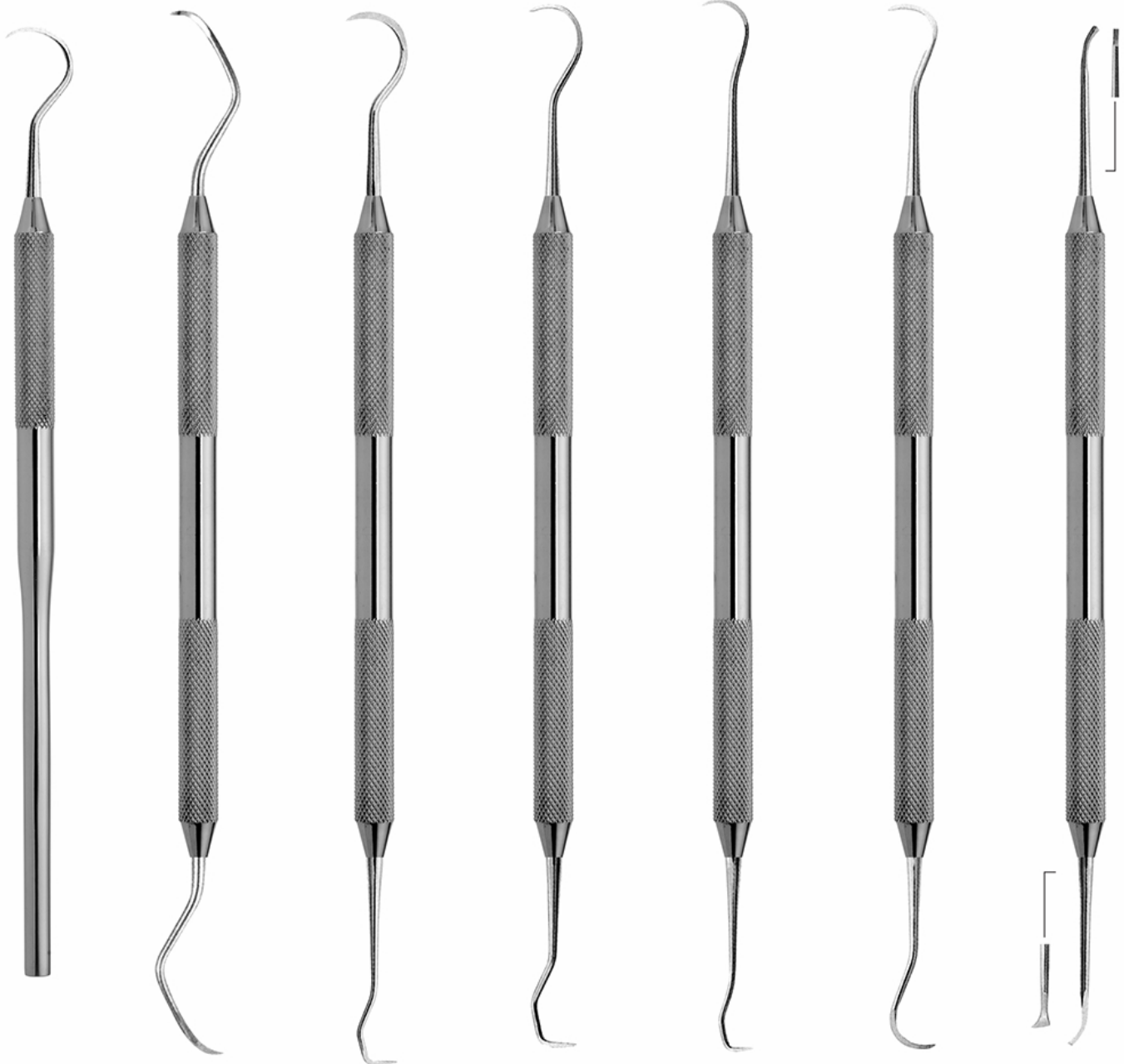

30.2048
Fig. U15
Towner

30.2051
Fig. M23
Universal
Scaler M23

30.2054
Fig. U15/33
Towner Jacquette

30.2057
Fig. U15/30
Towner Jacquette

30.2060
Fig. H5/33

30.2063
Fig. H6/H7

30.2066
Fig. 1/2

- Инструменты пародонтологические
- Instruments pour la parodontologie
- Instrumente für die Parodontologie

- Інструменти пародонтологічні
- instrumentos para periodoncia
- الصكوك اللثة

Scalers

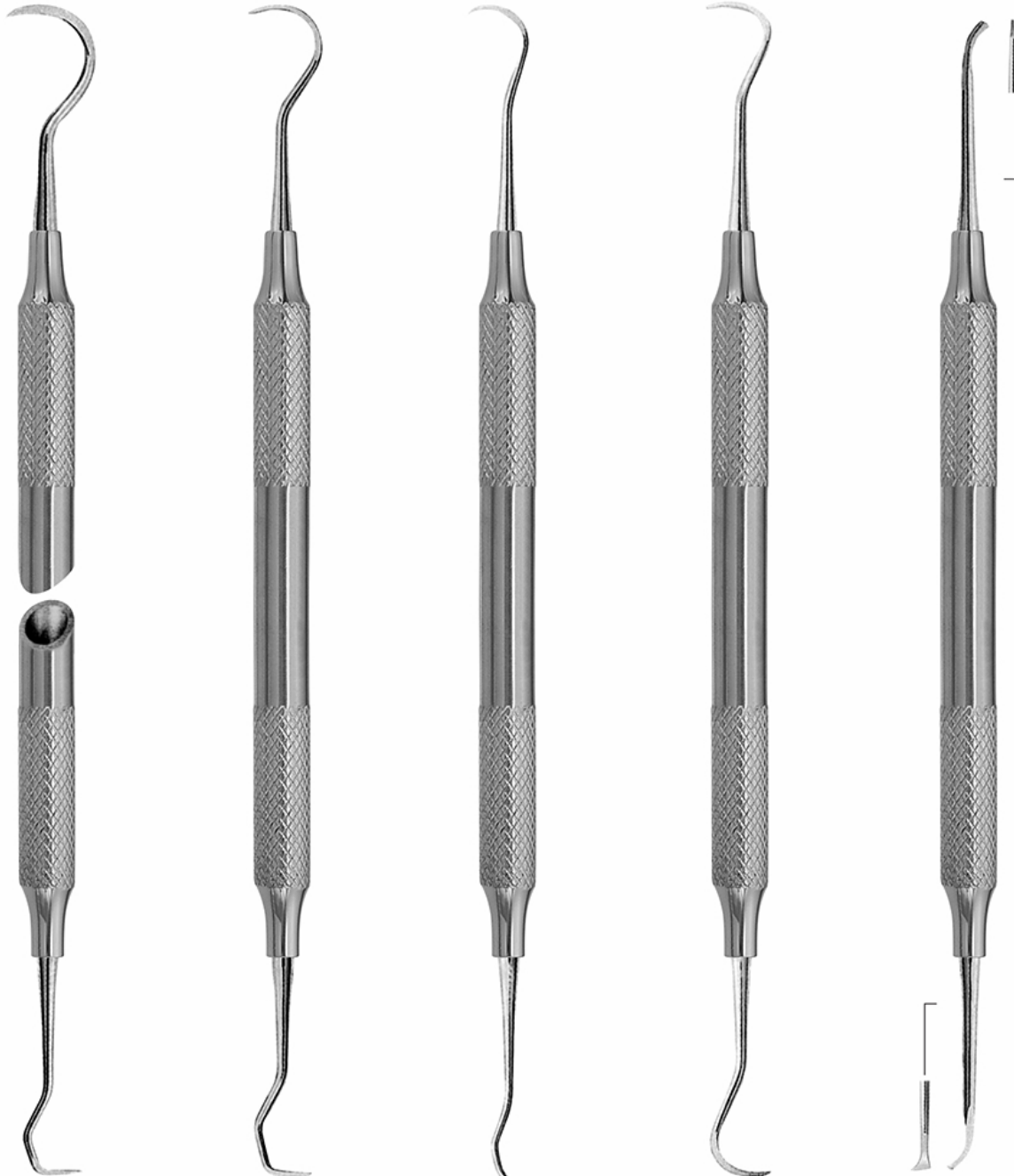

30.2069
Fig. U15/33
Towner Jacqueline

30.2072
Fig. U15/30
Towner Jacqueline

30.2075
Fig. H5/33

30.2078
Fig. H6/H7

30.2081
Fig. 1/2

- Инструменты пародонтологические
- Instruments pour la parodontologie
- Instrumente für die Parodontologie

- Інструменти пародонтологічні
- instrumentos para periodoncia
- الصكوك اللثة

Scalers



30-2084
Fig. 1

30.2087
Fig. 1L
Left

30.2090
Fig. 1R
Right

30.2093
Fig. 2L
left

30.2096
Fig. 2R
Right



30-2099
Fig. 33



30-2102
Fig. H5
Hygienist



30.2105
Fig. H6
Hygienist



30.2108
Fig. H7
Hygienist

WAX KNIVES

- Ножи для воска
- Couteaux a cire
- Wachsmesser

- Ножи для воску
- Cuchillos para cera
- السكاكين الشمع



30.2111
13 cm

Fahamenstock

30.2114
17 cm

30.2117
13 cm

rostfrei/stainless
inox

30.2120
17 cm

30.2123
13 cm

Lessmann

30.2126
17 cm

30.2129
13 cm

Ermert

- Ножи для воска
- Couteaux a cire
- Wachsmesser

- Ножі для воску
- Cuchillos para cera
- السكاكين الشمع



30.2132
Fig. 1
Fahnenstock
12.5 cm

30.2135
Fig. 2
Fahnenstock
17 cm

30.2138
Fig. 1
Lessmann
12.5 cm

30.2141
Fig. 2
Lessmann
17 cm

30.2144
Fig. 1
with small spoon
12.5 cm
з малою ложкою

30.2147
Fig. 2
with large spoon
17 cm
з великою ложкою

PLASTER KNIVES

- Ножи гипса
- Couteaux platre
- Gipsmesser Gisschneide- U.
- Ножи гіпсу
- Cuchillos yeso
- الجص للسكاكين



30.2150
Fig. 1
17 cm



30.2153
Fig. 2
Gritman
17 cm



30.2156
Fig. 3
16 cm



30.2159
Fig. 4
16 cm



ALGINATE & PLASTER SPATULAS

- Шпатель для замешивания
- Spatules a alginate et a platre
- Alginat- und Gipsspatel
- Шпатель для змішування
- Espatulas para alginato y para yeso
- ملاعق الجص الجينات



30.2162
Fig. Рис. 1
18.5 cm

30.2165
Fig. Рис. 2
18 cm

30.2168
Fig. Рис. 3
18.5 cm

30.2171
Fig. Рис. 4
19.5 cm

30.2174
Fig. Рис. 5
21.5 cm

30.2177
Fig. Рис. 6
20.5 cm

ALGINATE & PLASTER SPATULAS

- Шпатель для замешивания
- Spatules a alginate et a platre
- Alginat- und Gipsspatel
- Шпатель для змішування
- Espatulas para alginato y para yeso
- ملاعق الجص الجينات



30.2180
Fig. 7
19.5 cm

30.2183
Fig. 8
20 cm

30.2186
Fig. 9
22.5 cm

30.2189

30.2192

MALLETS - PLASTER SHEARS - SAWS & BLADES

• Молотки, ножницы, пилы и лезвия

• Молотки, ножиці, пилки і леза

• شفرات مناشير - الجص المقصات - مطارق



Horn tip

30.2195
200 mm
Рогоподібний кінчик



Metal tip

30.2198
220 mm
Металічний кінчик



Metal tip

30.2201
220 mm
Металічний кінчик

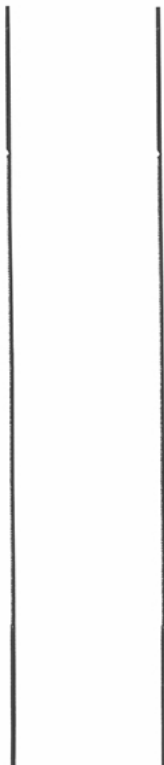

30.2204
For Plaster
Для парафіну

30.2207
For metal
Для металу

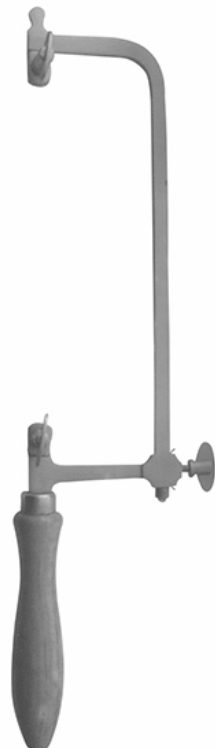

30.2210
Fret saw 250 mm
Лобзик



30.2213 250 mm
30.2217 320 mm
Crucible tongs. Щипці для тигелю

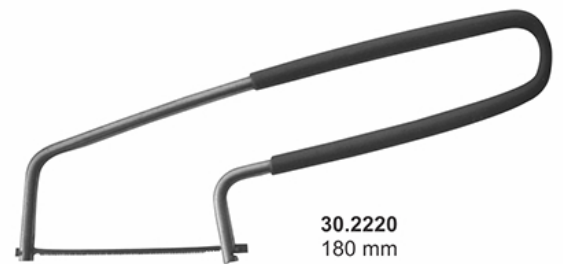

30.2220
180 mm



30.2223
0.12x5 mm



30.2226
0.25x5 mm



30.2229
0.25x3 mm

- Артикуляторы
- Artocilar
- Artikulations

- Артикулятори
- Articuler
- أرتيكولاتورس

30.2232

Technical Datas:

Intercondylar distance	120 mm.
condylar inclination	fixed at 30°
Bennet angle	fixed at 7°
Incisal table inclination	10°
Distance between mounting plates	110 mm.
Weight	700 gr.
Opening	180°

features:

Lightweight anatomic articulator made of aluminum die-casting. it can be used following the geometrical laws of medium values (Bonwill triangle). Fixing according to centric. Automatic return to the hinge axis with springs. Perfect stability also in reclused position. Easy access and visibility to the lingual surfaces. interchangeable self centring aluminum mounting plates.



Increased height and width

- (1) More space when using removable stumps systems.
- (2) More space for installation of mobile prosthesis with high chewing or big base.
- (3) More space when using magnetic plates



30.2235
Nakawalni
Dental Laboratory
Instrument

30.2238

Technical Datas:

Intercondylar distance	120 mm.
condylar inclination	fixed at 30°
Bennet angle	fixed at 7°
Incisal table inclination	flat
Distance between mounting plates	110 mm.
Weight	700 gr.
Opening	180°

Special Features:

Adjustable back by registration screw to work without incisal rod by keeping constant trajectories and inclinations during side and back/forward movements. Pure translation movement (key and instructions included). Anti-shock hinge rod in case articulator falls down. Bigger size lock screws for mounting plates.





- Артикуляторы
- Artocilar
- Artikulations

- Артикулятори
- Articuler
- أرتيكولاتورس

30.2241

Technical Datas:

Intercondylar distance	110 mm.
condylar inclination	fixed at 30°
Bennet angle	fixed at 7°
Incisal table inclination	10°
Distance between mounting plates	85 mm.
Weight	400 gr.
Opening	125°



30.2244

Technical Datas:

Intercondylar distance	110 mm.
condylar inclination	fixed at 30°
Bennet angle	fixed at 7°
Incisal table inclination	flat
Distance between mounting plates	85 mm.
Weight	450 gr.
Opening	180°



ARTICULATORS

- Артикуляторы
- Artocilar
- Artikulations

- Артикулятори
- Articuler
- أرتيکولاتورس



30.2247

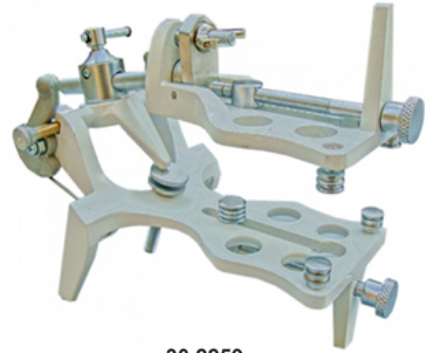

30.2259



30.2250
Copper Black Metallic
Мідний Чорний Металічний



30.2253
Stainless Steel Finishing
Нержавіюча сталь
30-2256
Royal Blue
королівський синій



30.2262



30.2265



30.2268



30.2271



30.2274

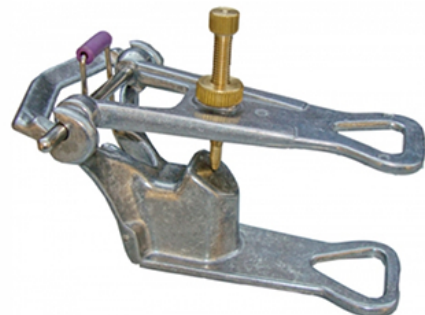

30.2277



ARTICULATORS

- Артикуляторы
- Artocilar
- Artikulations

- Артикулятори
- Articular
- أرتيكولاتورس



30.2280

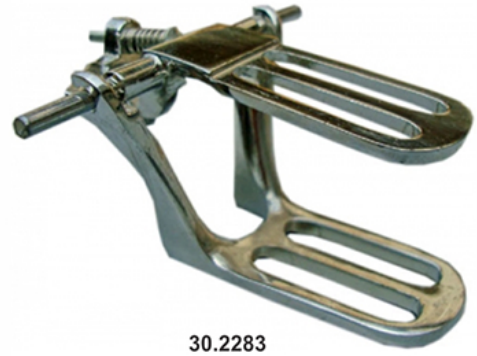

30.2283



30.2286



30.2289



30.2292



30.2295

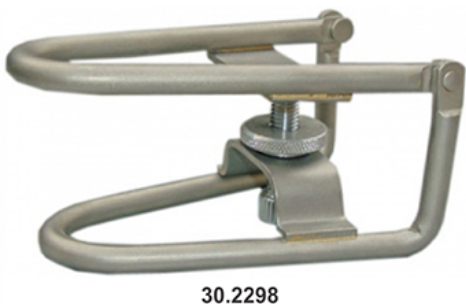

30.2298



30.2301

MISCELLANEOUS PRODUCTS

- Прочие товары
- Divers produits et services
- Sonstige Produkte
- Інші товари
- Varios Productos
- المنتجات المتنوعة

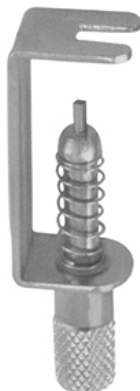

30.2304
Bur Changer Square Key
for Japanese Product
Скидач бору Квадратний
ключ для японського виробу

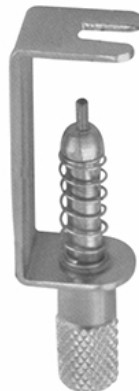

30.2307
Bur Changer
Hexagonal Key
Скидач бору Шестигранний
гайковий ключ

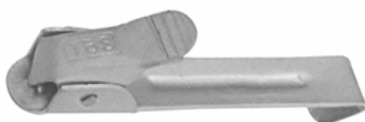

30.2310
X-ray Holder Clip Single
Кронштейн рентгену Одна скоба



30.2313
X-ray Holder Set of 6 Clips
Кронштейн рентгенуНабір з 6 скоб

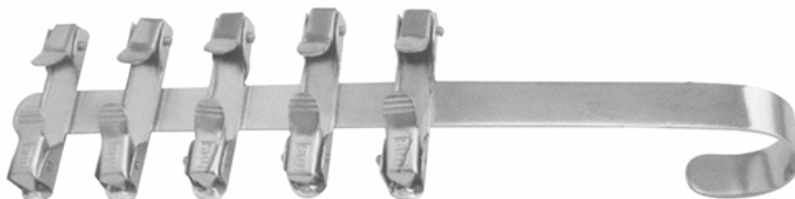

30.2316
X-ray Holder Set of 10 Clips
Кронштейн рентгенуНабір з 10 скоб

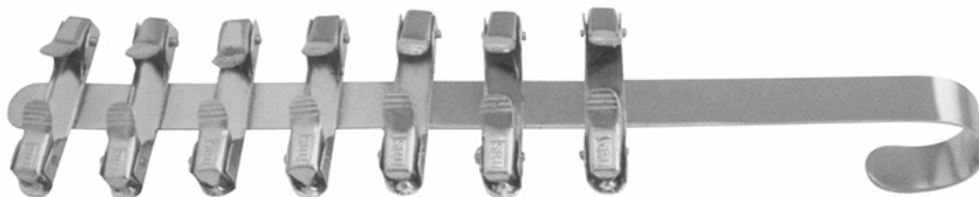

30.2319
X-ray Holder Set of 14 Clips
Кронштейн рентгенуНабір з 14 скоб



acme surgical®

www.acmesurgical.com