

20

Mouth, Tongue
Mund, Zunge
Boca, Lengua

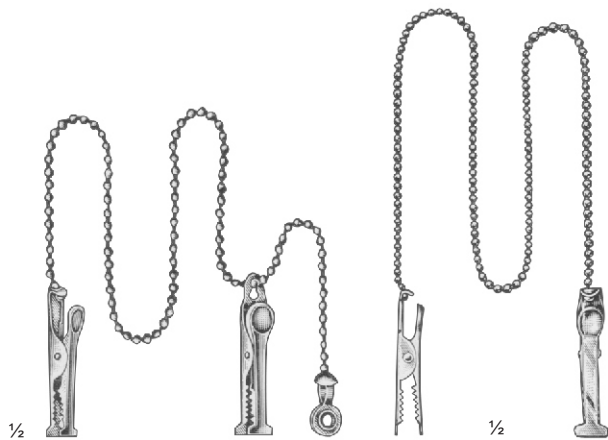

acme surgical
www.acmesurgical.com



Mod. Acme
S20.101.01
length adjustable
Länge verstellbar
largo regulable

Adams
S20.103.01

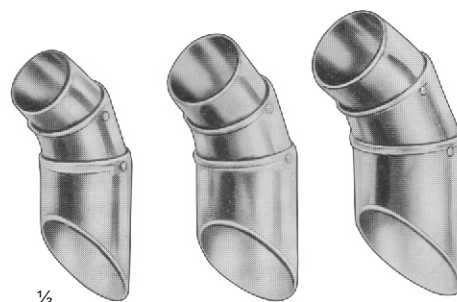

S20.111.01 S20.111.02 S20.111.03

Langenbeck



Mauder
S20.120.10

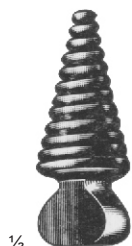

Mauder
S20.120.11

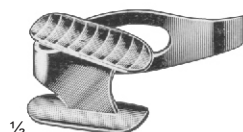

Baisch
S20.121.01



Pitha
S20.125.10, S20.125.11

sterilizable in hot air
in Heißluft sterilisierbar
esterilizable en aire caliente

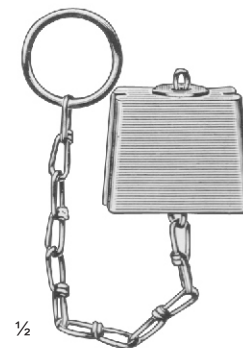

Pitha
S20.127.02 = Fig. 2

Fig.	a	b	c
	2	28	30 30 mm

S20.101.01 - S20-103-01
S20.111.01 - S20-111-03
S20.120.10
S20-120-11
S20-121-01
S20-125-10

S20-125-11
S20-127-02

Napkin Holders
Finger Protectors
Oral Screw, of wood
ditto, of hard rubber
Mouth Gag and Jaw Prop
Oral Wedge of silicone rubber
with handle
Spare Rubber Wedge
Rubber Wedge, with chain

- Serviettenhalter
- Fingerschützer
- Mundkeil, aus Holz
- dito, aus Hartgummi
- Mundoffenhalter und kieferstütze
- Mundkeil, aus Silicongummi,
mit Griff
- Ersatz-Gummikeil
- Mundkeil, aus Gummi, mit kette

- Porta-servilletas
- Dedales (Protectores de dedos)
- Garrote, de madera
- idem, de ebonita
- Abre-boca y Apoyo-mandíbula
- Garrote de silicio, con mango

- Garrote de repuesto, de goma
- Garrote de goma, con cadena

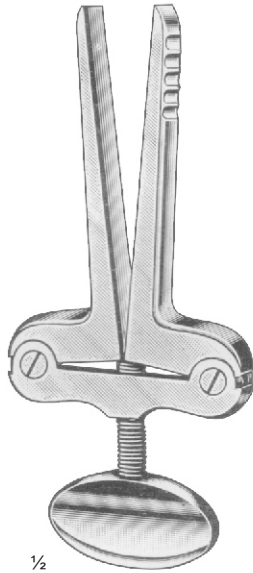

½
Heister
S20.140.130
13 cm / 5"

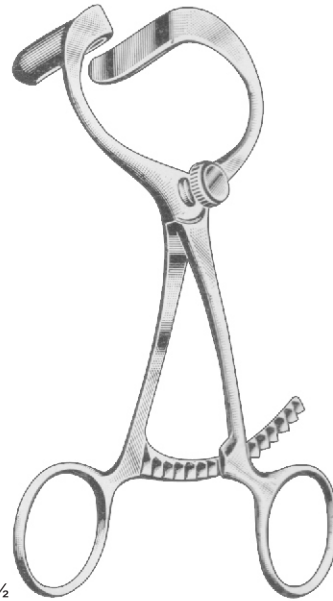

½
Doyen-Collion
S20.155.130
13 cm / 5"

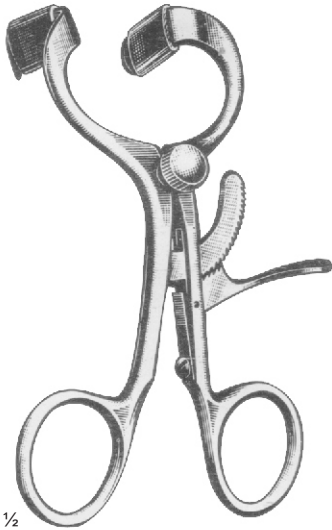

½
Molt
S20.161.110
11 cm / 4½"

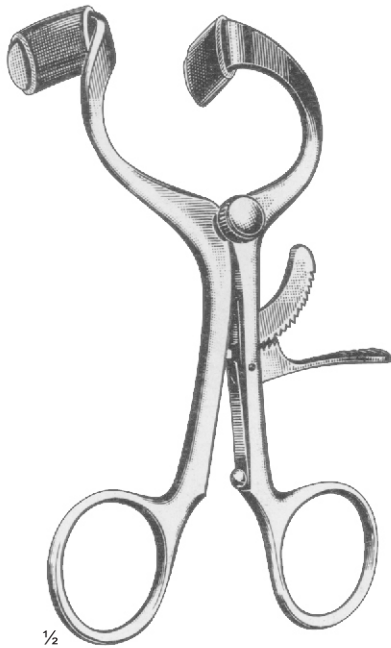

½
Molt
S20.161.140
14 cm / 5½"

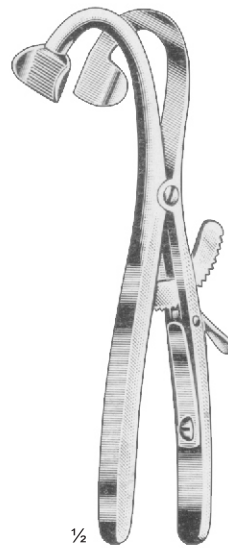

½
Denhart
S20.171.120
12 cm / 4¾"

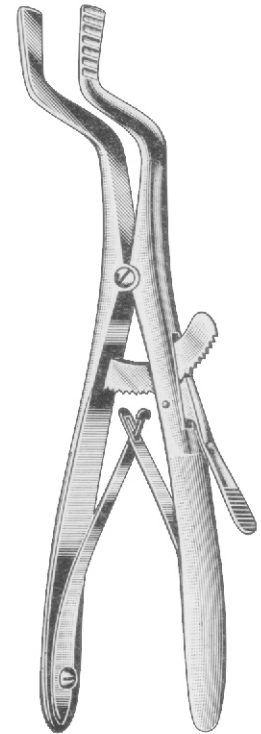

Roser-König
S20.179.160 = 16 cm / 6¼"
S20.179.190 = 19 cm / 7½"

S20.155.130
S20.161.110 - S20-179-190

with soft metal lining
with Loktite ratchets

- mit weichmetallbelag
- mit Loktite-Sperren

- con cubierta de metal blando
- con cremalleras Loktite



Kilner-Doughty
S20.198.00
S20.198.10



½
S20.198.01
Fig.1

½
S20.198.02
Fig. 2

½
S20.198.03
Fig. 3



- S20.198.00 Complete with Frame, 3 Tongue Depressors and 2 Adjustable Tooth Plates, exchangeable, and 1 palatal Support for toothless
- S20.198.01 Tongue Depressor Fig 1, only
- S20.198.02 ditto, Fig. 2, only
- S20.198.03 ditto, Fig. 3, only
- S20.198.10 Gag only

- Komplett mit Rahmen, 3 Zungendrückern, sowie 2 beweglichen, auswechselbaren Zahnplatten und 1 Gaumenplatte für Zahnlose.
- Zungendrücker Fig. 1, allein
- dito, Fig. 2
- dito, Fig. 3
- Sperrer allein

- Completo con cuadro, 3 abajalengua y 2 soportes de dientes móviles e intercambiables, 1 soporte de paladar para desdentados
- Abajalengua fig. 1, suelto
- idem, fig. 2, suelto
- idem, fig. 3, suelto
- Abre-boca suelto

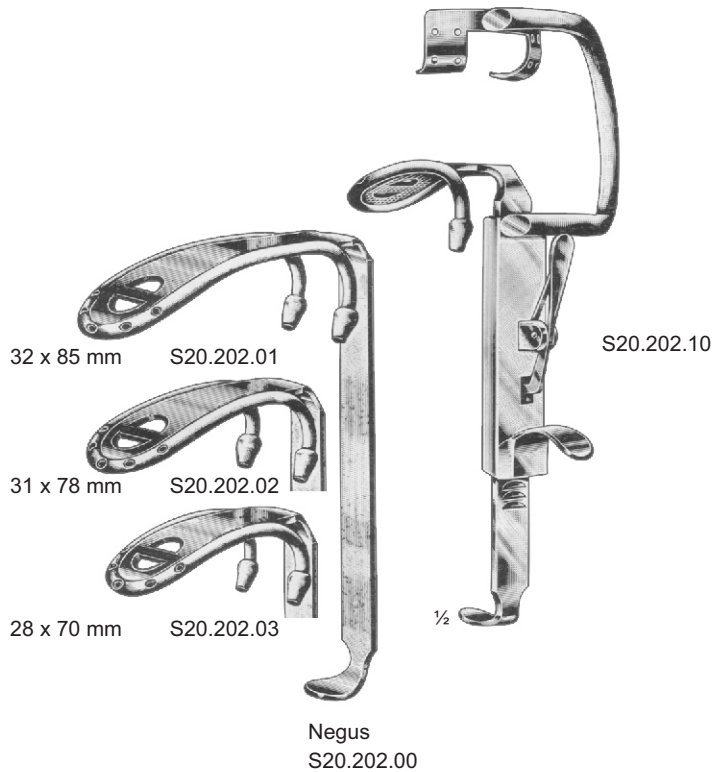

S20.202.00 Complete with frame (Handle) and 3 interchangeable tongue depressors, with 2 anaesthetic tubes
S20.202.01 - S20.202.03 Tongue Depressors only
S20.202.10 Frame (Handle) only

S20.202.00 Komplet mit Sperrbügelgriff und 3 auswechselbaren Zungenspateln, mit 2 Narkosezuleitungen
S20.202.01 - S20.202.03 Zungenspatel, allein
S20.202.10 Sperrbügelgriff, allein

S20.202.01 - S20.202.03 Completo con mango y cuadro, 3 abaja-lengua intercambiables con 2 tubos de anestesia
S20.202.10 Abaja-lengua sueltos
Mango y cuadro suelto

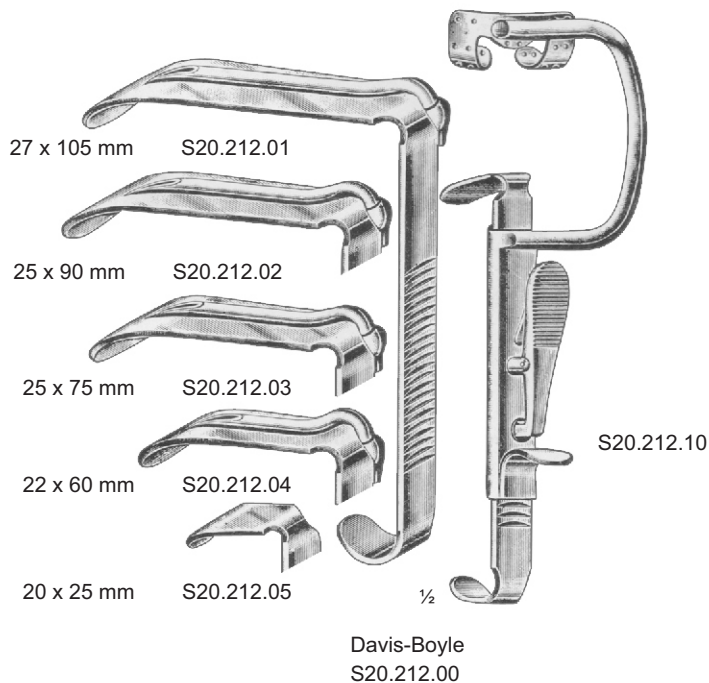

S20.212.00 Complete with frame (Handle) and 5 interchangeable tongue depressors, S20.212.01 - 04 with 1 anaesthetic tubes each
S20.212.01 - S20.212.05 Tongue Depressors only
S20.212.10 Frame (Handle) only

S20.212.00 Komplet mit Sperrbügelgriff und 5 auswechselbaren Zungenspateln, mit 1 Narkosezuleitungen
bei S20.212.01 - 04 Zungenspatel, allein
S20.212.01 - S20.212.05 Sperrbügelgriff, allein
S20.212.10

S20.212.00 Completo con mango y cuadro, 5 abaja-lengua intercambiables, S20.212.01 - 04 con 1 tubo de anestesia
S20.212.01 - S20.212.05 Abaja-lengua sueltos
S20.212.10 Mango y cuadro suelto

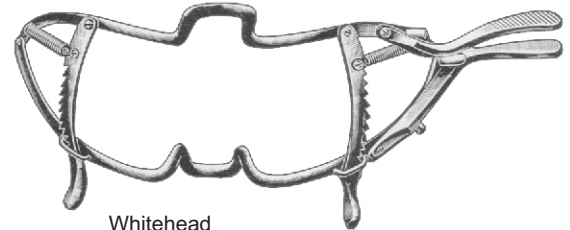
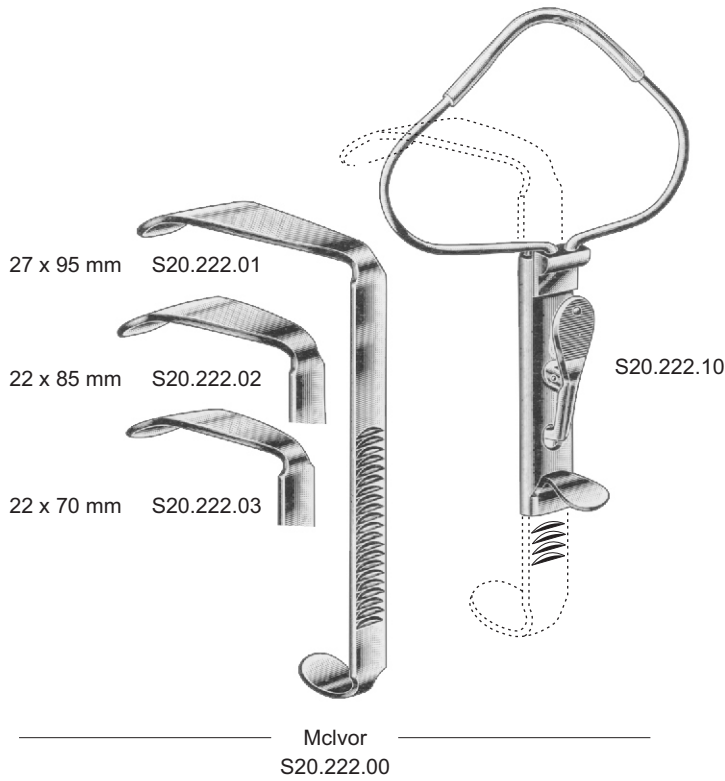

Whitehead
S20.231.110 = 11 cm / 4 1/4"
S20.231.130 = 13 cm / 5"
S20.231.150 = 15 cm / 6"

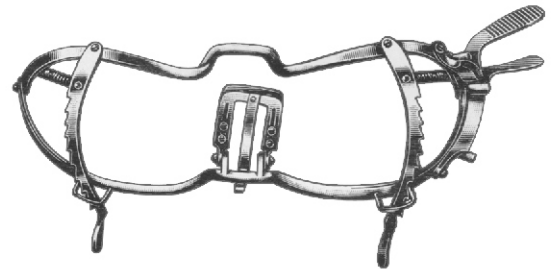

Whitehead
S20.233.130 = 13 cm / 5"

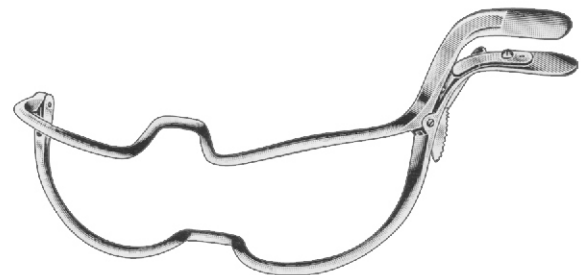

Jennings
S20.237.90 = 9 cm / 3 1/2"
S20.237.110 = 11 cm / 4 1/2"
S20.237.130 = 13 cm / 5"
S20.237.150 = 15 cm / 6"

- S20.222.00 Complete with frame (Handle) and 3 interchangeable tongue depressors, without anaesthetic tubes
- S20.222.01 - S20.222.03 Tongue Depressors only
- S20.222.10 Frame (Handle) only
- S20.222.00 Komplet mit Sperrbügelgriff und 3 Zungenspateln ohne Narkosezuleitung
- S20.222.01 - S20.222.03 Zungenspatel, allein
- S20.222.10 Sperrbügelgriff, allein
- S20.222.00 Completo con mango y cuadro, con 3 abaja-lengua intercambiables, sin tubo de anestesia
- S20.222.01 - S20.222.03 Abaja-lengua sueltos
- S20.222.10 Mango y cuadro suelto

- | | | | |
|---------------------------|--|--|--|
| S20.231.110 - S20.231.150 | with one lateral handle, without tongue depressor | - mit 1 seitlichen Griff, ohne Zungendrücker | - con 1 mango lateral, sin abaja-lengua |
| S20.233.130 | ditto, with tongue depressor | - dito, mit Zungendrücker | - idem, con abaja-lengua |
| S20.237.90 - S20.237.150 | ditto, without tongue depressor with Loktite ratchet | - dito, ohne Zungendrücker
- mit Loktite-Sperre | - idem, sin abaja-lengua, con cremallera Loktite |

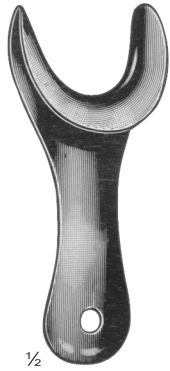

Acme-Simplex
 S20.243.110
 11 cm / 4½"

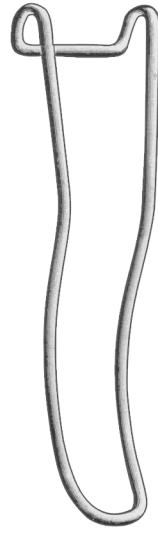

Sternberg



Sternberg

	cm	in	
	12	4¾	S20.249.120
S20.247.140	14	5½	S20.249.140
S20.247.160	16	6¼	S20.249.160
S20.247.180	18	7	

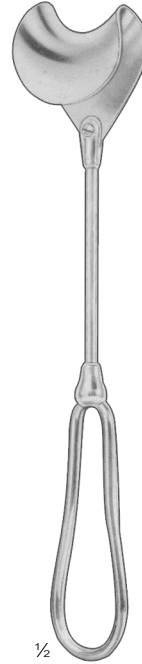

Mod. Acme
 S20.255.190
 19 cm / 7½"

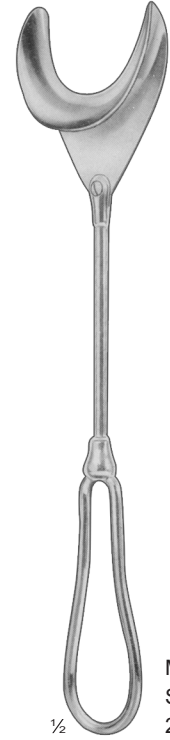

Mod. Acme
 S20.257.210
 21 cm / 8¼"



Bishop
 S20.261.130
 13 cm / 5"



Moritz-Schmidt
 S20.265.190
 19 cm / 7½"
 hollow - hohl - hueco



Hartmann
 S20.271.150
 15 cm / 6"



Tobold
 S20.277.145
 14,5 cm / 5½"
 solid . massiv . macizo

- S20.243.110
- S20.247.140 - S20.249.160
- S20.255.140 - S20.257.160
- S20.261.130
- S20.265.190 - S20.277.145

- Cheek Retractor
- Lip Retractors
- Cheek Retractors, with swivel blades
- Combined Cheek and Lip Retractor
- Tongue Depressors

- Wangenhalter
- Lippenhalter
- Mundwinkelhalter mit beweglichen Valven
- Wangen-und Lippenhalter kombiniert
- Zungendrucker

- Separador para mejillas
- Separadores para labios
- Separadores para mejillas, con valvas movibles
- Separador combinado para labios y mejillas
- Abaja-lengua

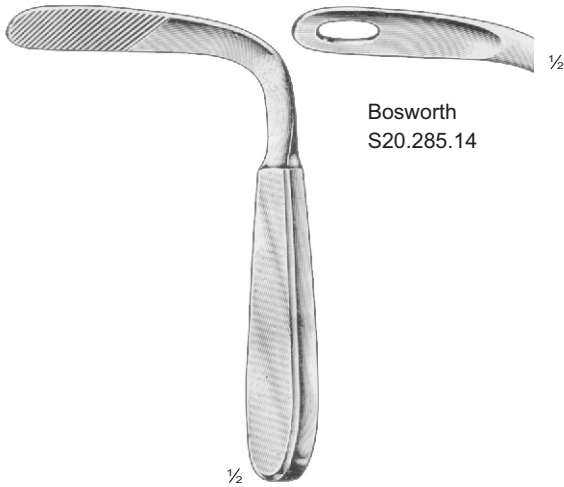

Bosworth
S20.285.14



Andrew
S20.293.110
11 cm / 4 1/2"

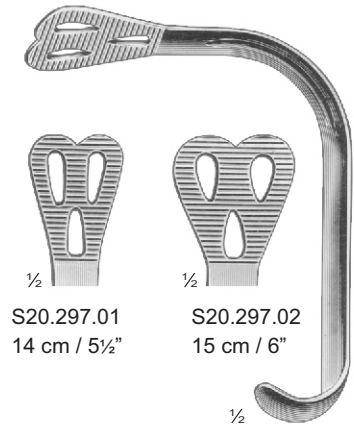

S20.297.01
14 cm / 5 1/2"

S20.297.02
15 cm / 6"

Wieder

Tobold
S20.281.145
14,5 cm / 5 1/2"
hollow - hohl - hueco

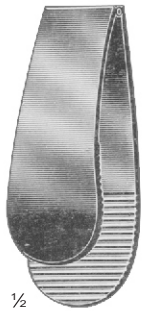

Tobold
S20.305.120
12 cm / 4 3/4"

folding type
zusammenlegbar
plegable

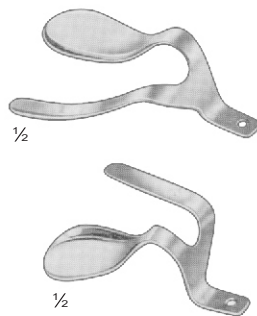

Acme-Zuwafix
S20.325.00

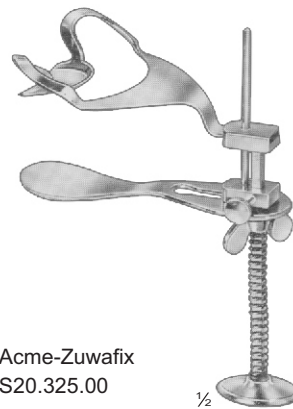

Tapia
S20.330.190
19 cm / 7 1/2"

S20.281.145 - S20.305.120
S20.325.00

Tongue Depressors
Tongue Depressor and cotton
Roll Holder, with chin Holder

- Zungendrucker
- Zungen- und Watterollen-
halter mit Kinnstütze

- Abaja-lengua
- Abaja-lengua con soporte para
rollos de algodón y sostén para el
mentón

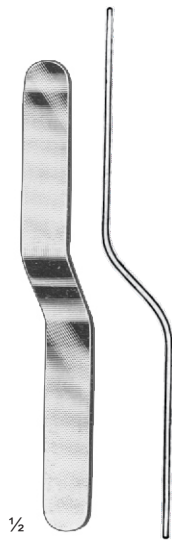

$\frac{1}{2}$
S20.371.145
14,5 cm / 5 $\frac{3}{4}$ "

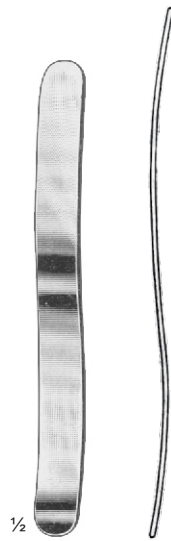

$\frac{1}{2}$
S20.373.145
14,5 cm / 5 $\frac{3}{4}$ "



Doyen
S20.375.130 = 13 cm / 5"
S20.375.160 = 16 cm / 6 $\frac{1}{4}$ "

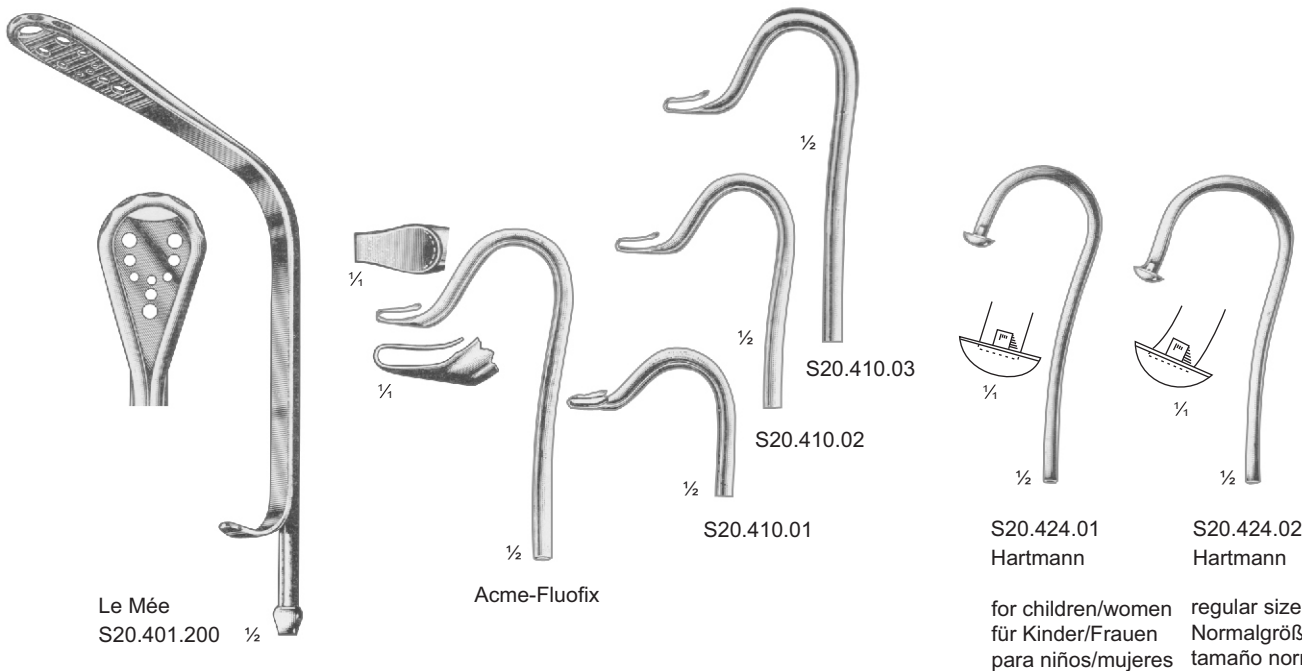
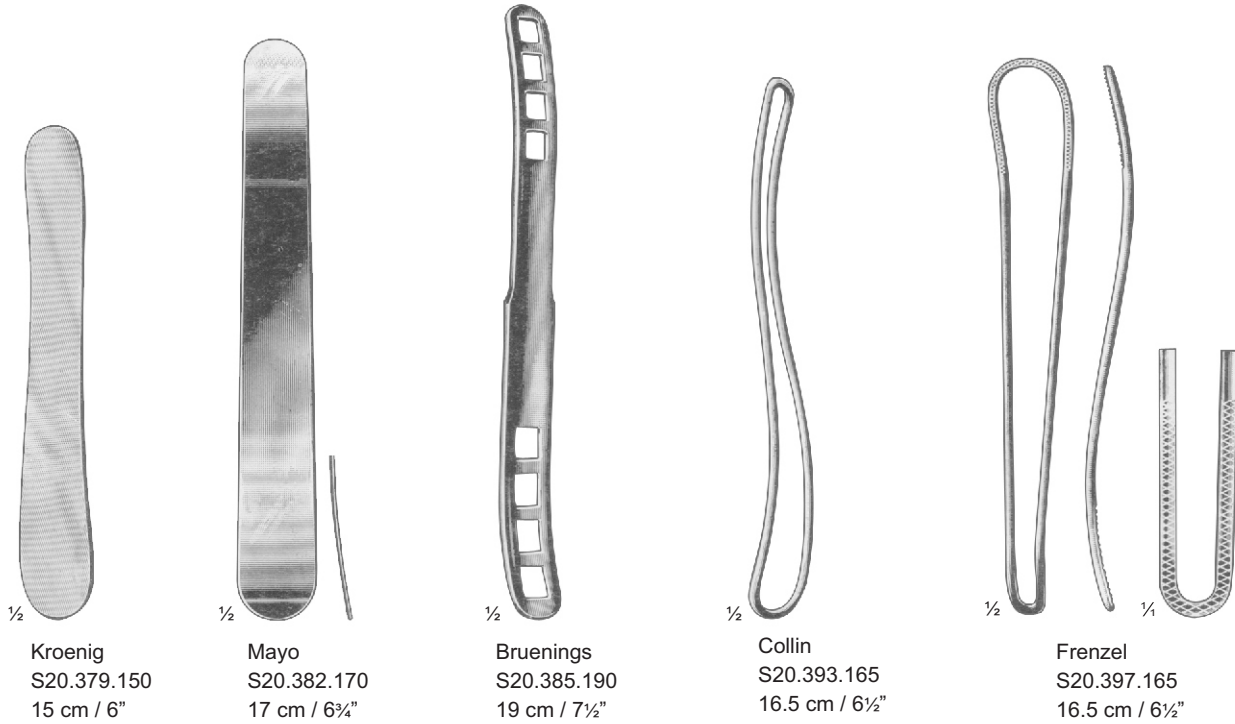

S20.401.200

Tongue Depressor, with suction tube and hollow surface to catch-up tonsil or adenoid residui

- Zungenspatel, mit Absaugrohr und vertiefter Oberfläche zum Auffangen von Tonsillen- und Adenoidresten

- Abaja-lengua, con tubo aspirador y superficie cóncava para recoger restos de amígdalas y de vegetaciones adenoideas

S20.401.01 - S20.410.03

Saliva Ejectors, with tongue shaped outlet tube

- Speichelsauger, mit zungenförmiger Abflußöffnung

- Tubos para saliva, con tapa en forma de lengüeta

S20.424.01 - S20.424.02

ditto, with sucking shell

- dito, mit schalenförmigen Metall-saugnapfen

- idem, con concha de aspiración

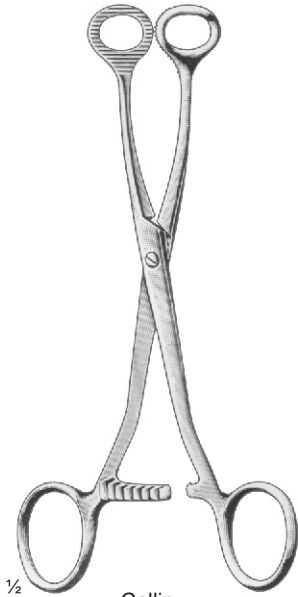

1/2
Collin
S20.450.160
16 cm / 6 1/4"

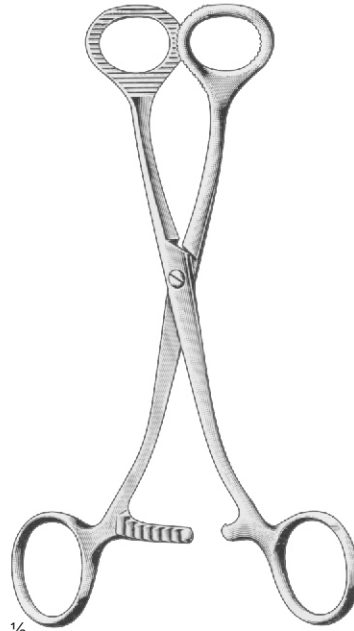

1/2
Collin
S20.452.170 = 17 cm / 6 3/4"
S20.452.190 = 19 cm / 7 1/2"

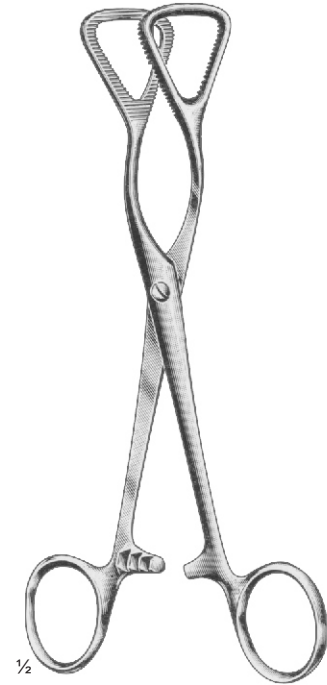

1/2
Guy
S20.458.190
19 cm / 7 1/2"

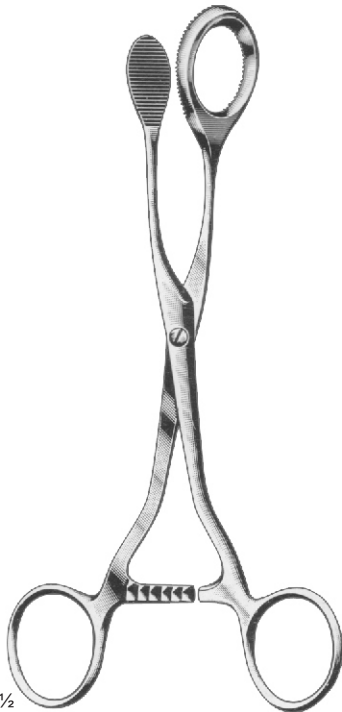

1/2
Mathieu
S20.462.190
19 cm / 7 1/2"

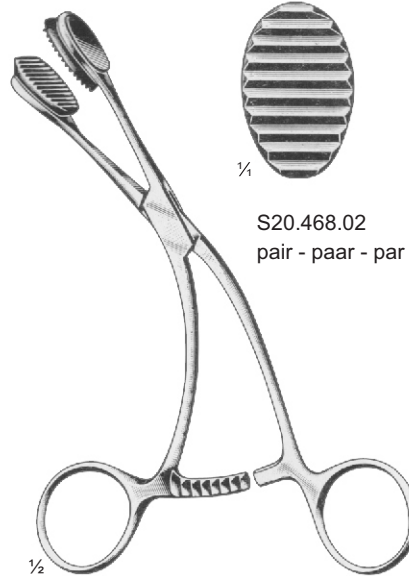

1/2
Young
S20.467.170
17 cm / 6 3/4"



S20.468.02
pair - paar - par

S20.450.160 - S20.467.170

Tongue Holding Forceps, with interchangeable toothed rubber jaws

S20.468.02

Rubber jaws only

Zungenzangen, mit auswechselbarem gezahnten Gummipolster
Gummipolster, allein

- Pinzas tira-lengua, con bocas dentadas intercambiables de goma blanda
- Bocas de goma sueltas



***acme* surgical**
www.acmesurgical.com