

14

Liver, Gall, Kidney, Bladder, Urology
Leber, Galle, Niere, Blase, Urologie
Higado, Bilis, Riñón, Vejiga, Urologia



acme surgical
www.acmesurgical.com

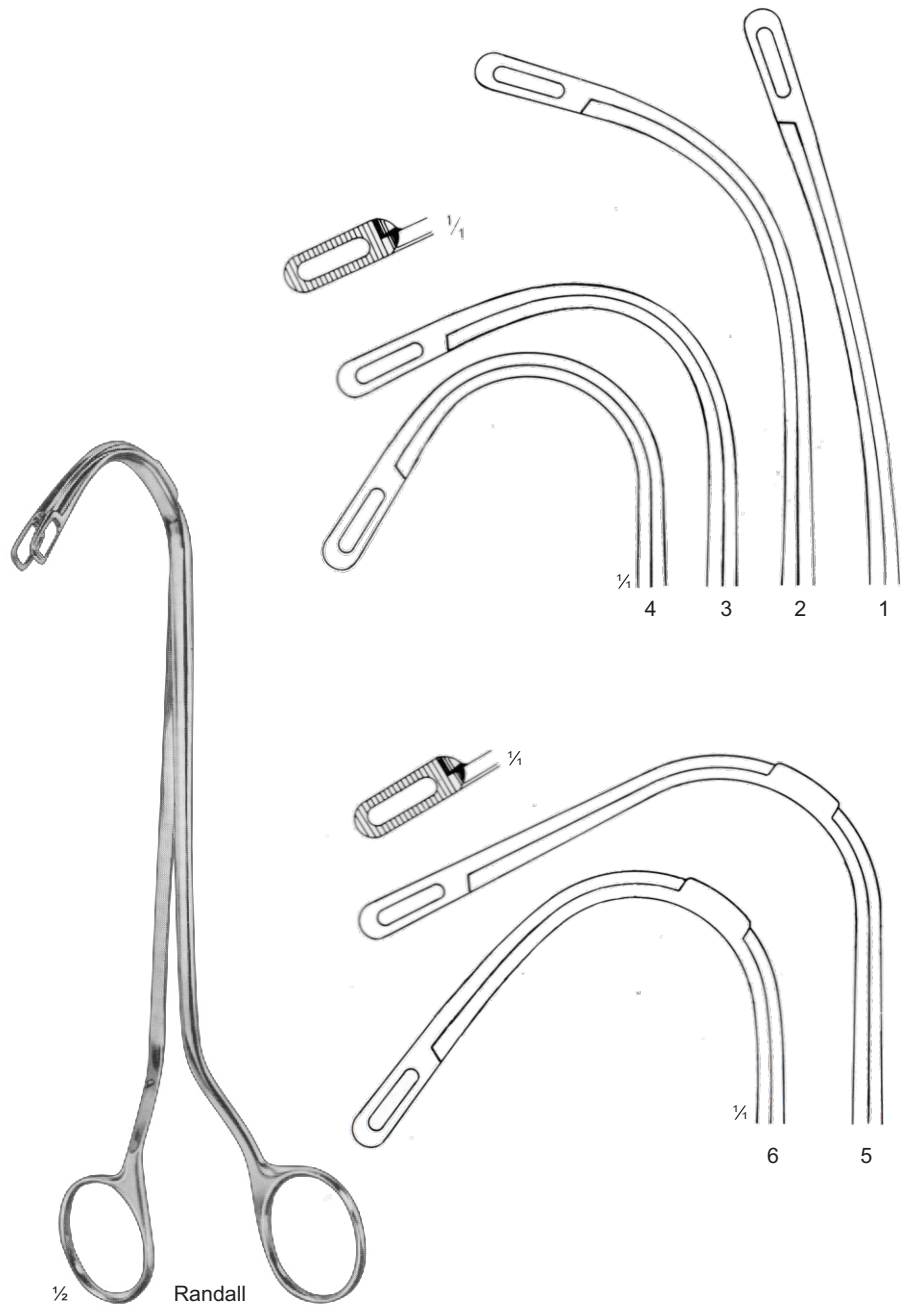
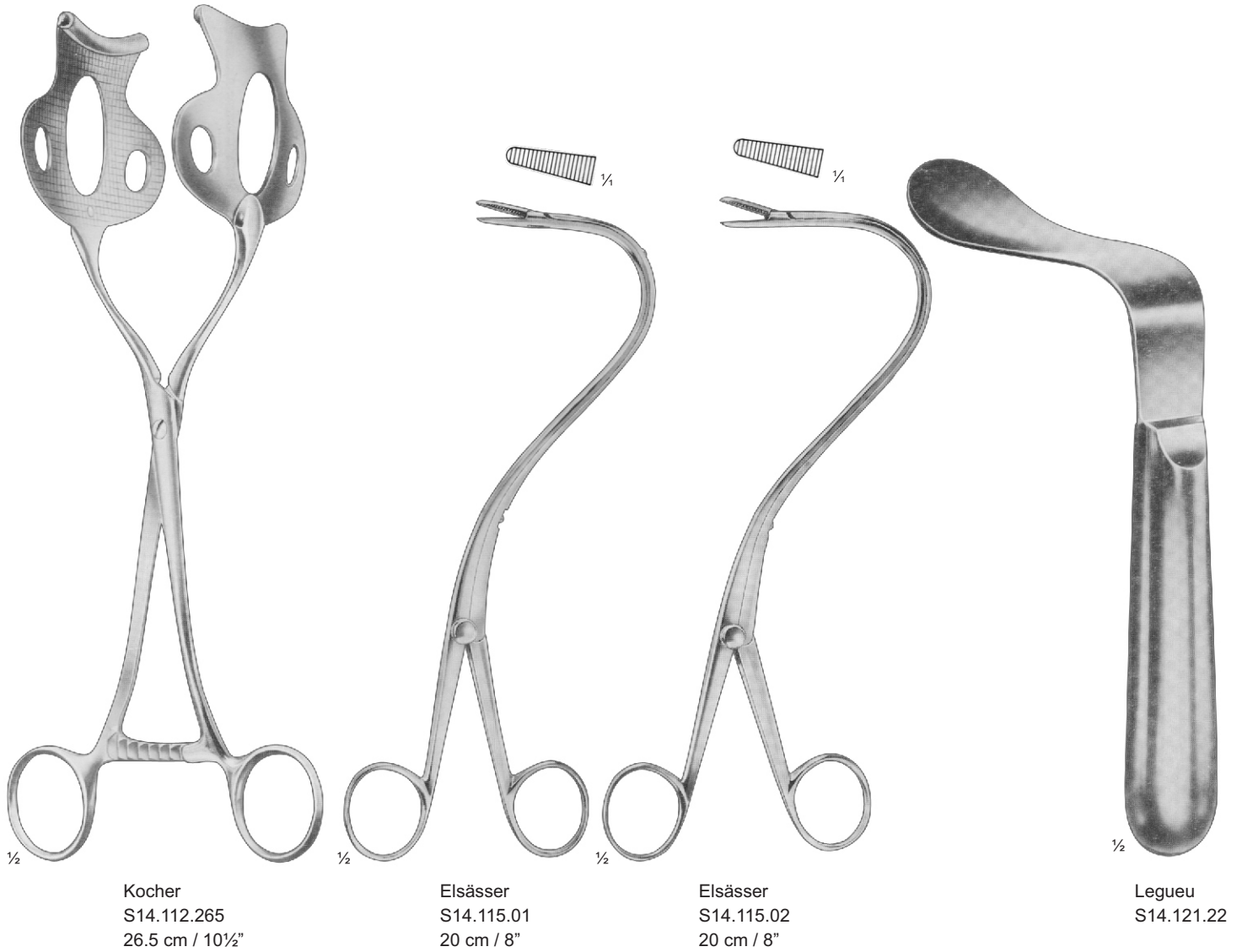
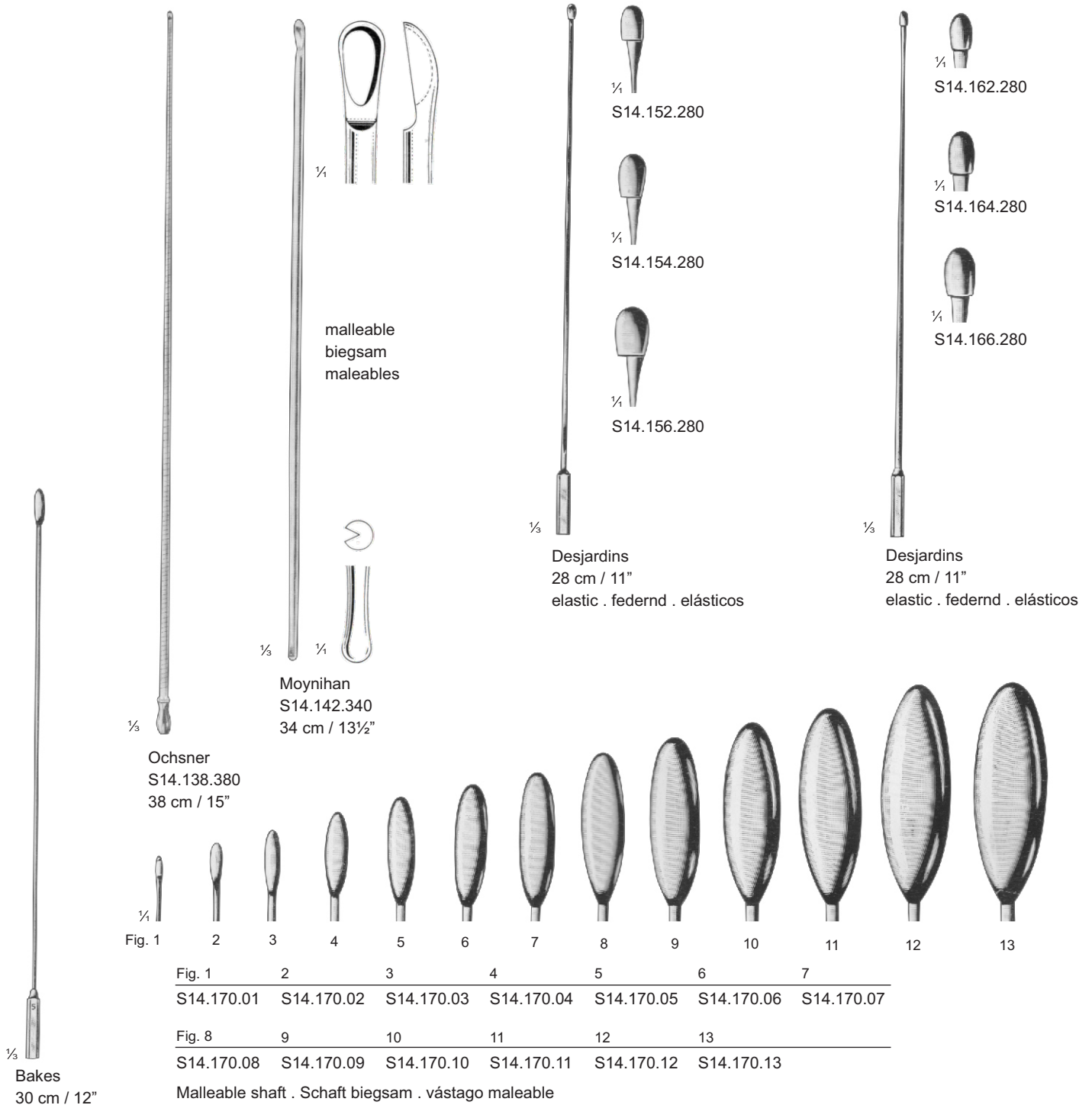

Fig.	cm	in.	
1	23	9	S14.101.230
2	22	8 $\frac{3}{4}$	S14.103.220
3	22	8 $\frac{3}{4}$	S14.105.220
4	22	8 $\frac{3}{4}$	S14.107.220
5	19	7 $\frac{1}{2}$	S14.109.190
6	19	7 $\frac{1}{2}$	S14.111.190



- | | | | |
|-----------------|--------------------------|--------------------|--------------------------------|
| S14.112.265 | - Kidney Holding Forceps | Nierenfaßzange | - Pinza para sostener el riñón |
| S14.115.01 - 02 | - Nephrostomy Forceps | Nierenfistelzangen | - Pinzas a para nefrostomía |
| S14.121.22 | - Kidney Spatula | Nierenspatel | - Espátula renal |



S14.138.380	Gall Duct Probe, with stilette, malleable	- Gallenkanalsonde, mit Stilette, biegsam	- Estilete para conductos biliares, con mandril maleable
S14.142.340	Gall Stone Probe, malleable, of tin	- Gallensteinsonde, biegsam, aus Zinn	- Explorador para cálculos biliares, maleable, de estaño
S14.152.280 - S14.156.280	Gall Stone Probes, elastic	Gallensteinsonden, federnd	Exploradores para cálculos biliares, elásticos
S14.162.280 - S14.166.280	with eccentric olives	- mit exzentrischen Oliven	- con olivas excéntricas
S14.170.01 - S14.170.13	with centric olives	- mit zentrischen Oliven	- con olivas centrales
	Gall Duct Dilators, copper shaft, malleable	- Gallenkanal-Dilatatoren, Schaft aus Kupfer, biegsam	- Dilatadores para conductos biliares, vástago de cobre, maleables

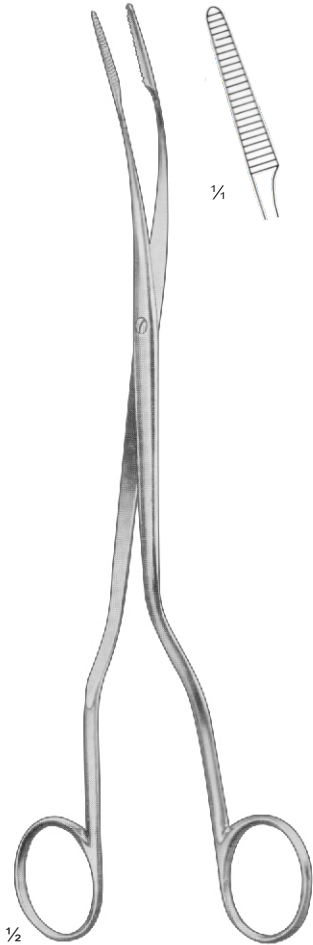

Czerny
S14.201.245
24.5 cm / 9 3/4"

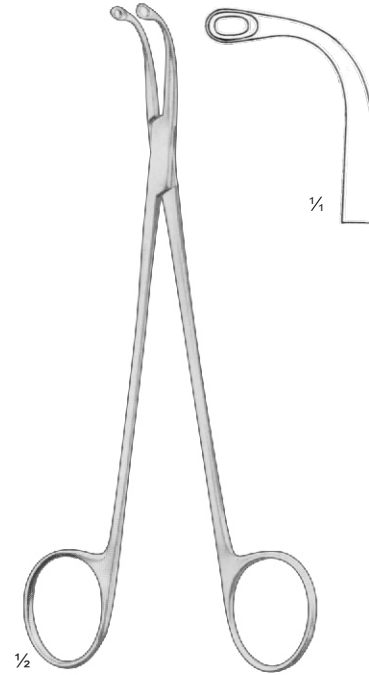

Turner-Warwick
S14.203.180
18 cm / 7"

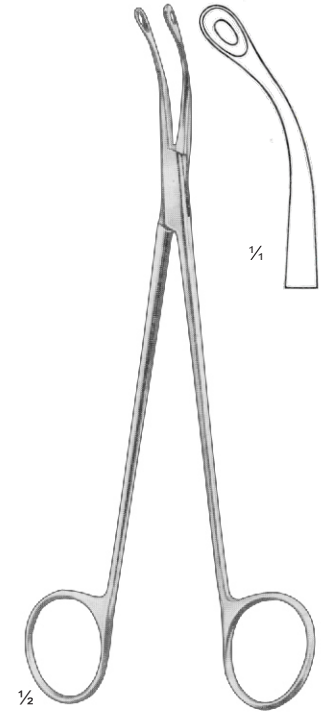

Turner-Warwick
S14.203.190
19 cm / 7 1/2"

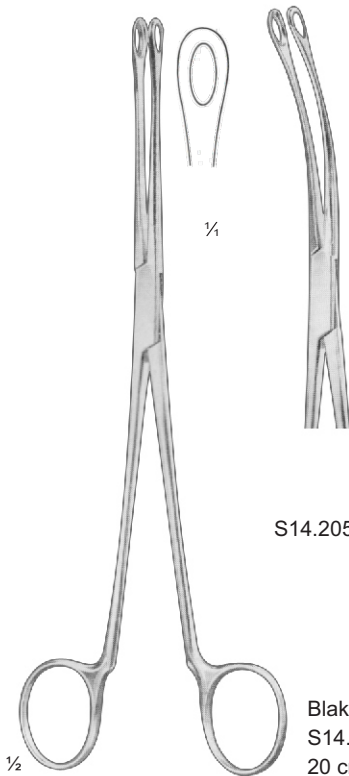

S14.205.200

Blake
S14.204.200
20 cm / 8"



Mayo-Blake
S14.214.200
20 cm / 8"

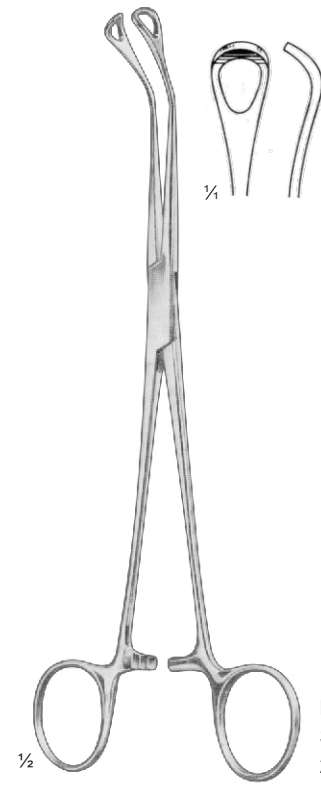

Mayo-Blake
S14.215.200
20 cm / 8"



1/2

Mixer
S14.217.220
22 cm / 8 3/4"

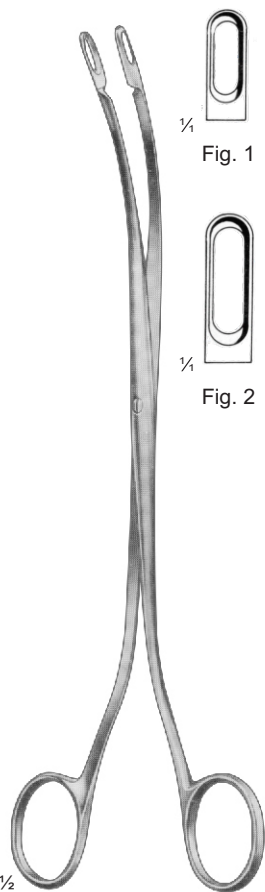

1/2

Desjardins
23 cm / 9"

S14.223.230 = Fig.1
S14.225.230 = Fig.2

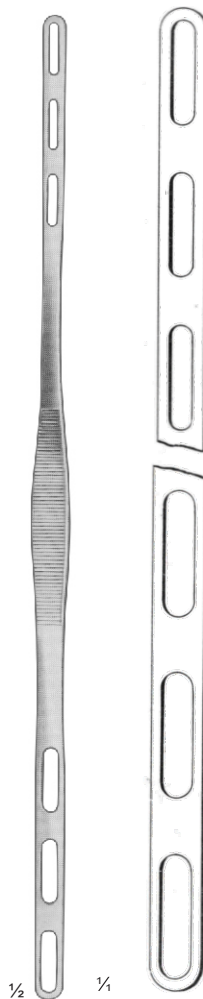

1/2

1/4

S14.320.265
26.5 cm / 10 1/2"

malleable
biegsam
maleable

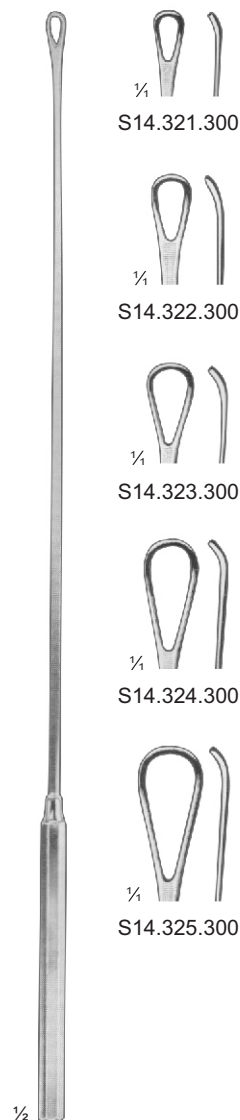

1/2

S14.321.300

S14.322.300

S14.323.300

S14.324.300

S14.325.300

Mod. Muenchen
30 cm / 12"

elastic . federnd . elásticas

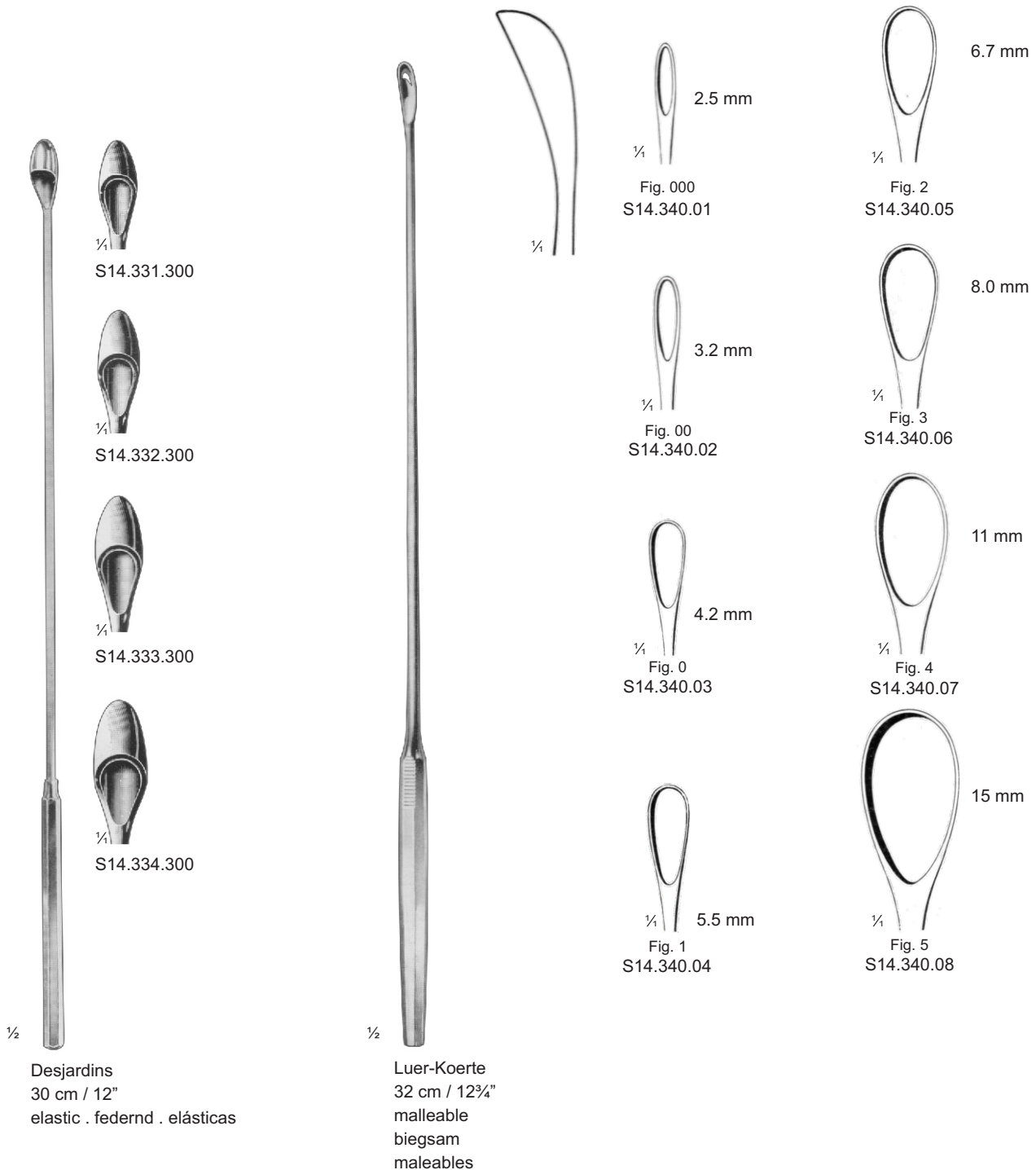

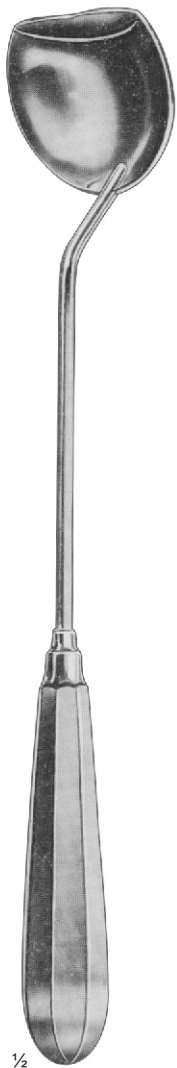

1/2

Moore
S14.355.280
28 cm / 11"



1/2

Mayo
S14.358.280
28 cm / 11"



1/2

S14.361.340
34 cm / 12 1/2"



1/4

Fergusson
S14.362.215
21.5 cm / 8 1/2"



1/4

Fergusson
S14.362.220
22 cm / 8 3/4"



1/4

Fergusson
S14.362.235
23.5 cm / 9 1/4"



La Place
 S14.381.340
 34 cm / 13½"

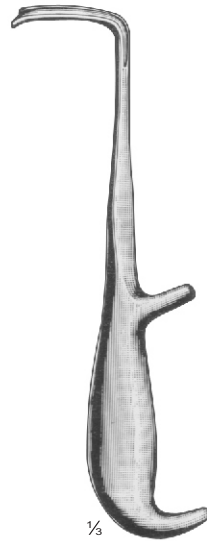

Young
 S14.401.210
 21 cm / 8¼"

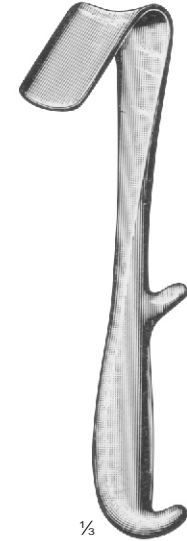

Young
 S14.403.220
 22 cm / 8¾"

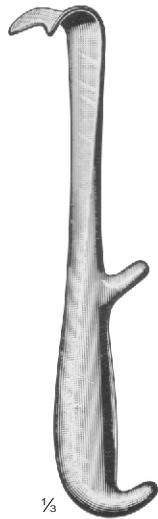

Young
 S14.405.210
 21 cm / 8¼"
 for bulb . für Bulbus . para el bulbo

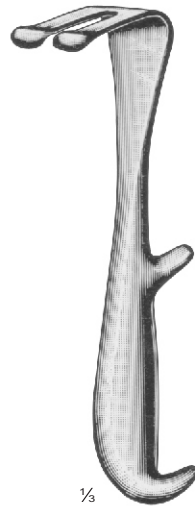

Young
 S14.407.220
 22 cm / 8¾"

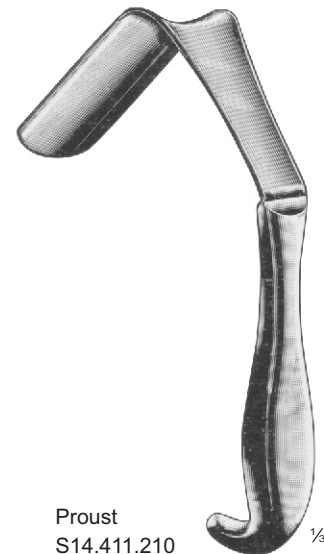

Proust
 S14.411.210
 21 cm / 8¼"
 for external sphincter . für Steißbein . para coxis

S14.381.340

- Liver Retractor for operations of gall bladder and gall ducts

Leberhaken, zur Operation an Gallenblase und Gallengang

- Separador del hígado para operaciones de la vesícula y de los conductos biliares

S14.401.210 - S14.407.220

- Prostatic Retractors

Prostatahaken

- Separadores para la próstata

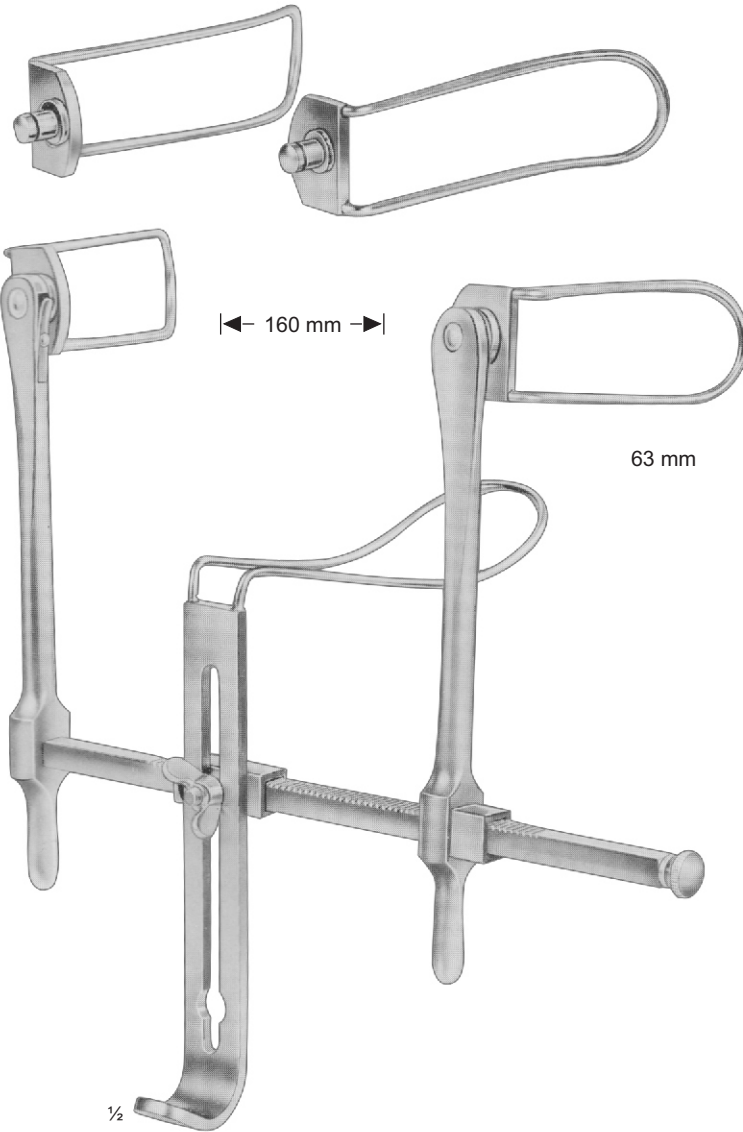

Gosset
 S14.470.00

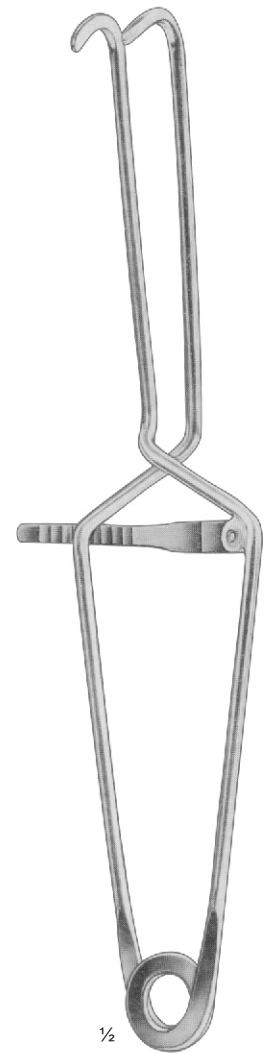

Millin
 S14.475.00

- | | | | |
|------------|----------------------------------------|---------------------|------------------------------------|
| S14.470.00 | - Bladder Retractor | Blasen-Wundspreizer | - Separador de vejiga |
| S14.475.00 | - Meatus Clamp (Bladder Neck Spreader) | Blasenhalsperrerr | - Dilatador para el cuello vesical |

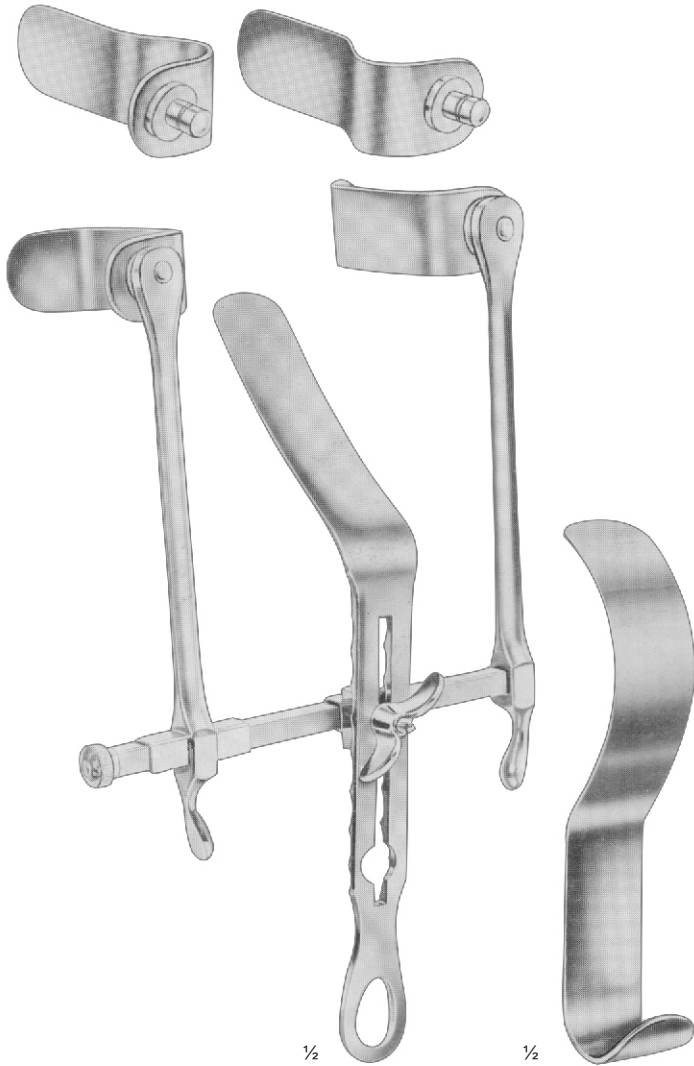

1/2 Thomson-Walker
S14.503.00

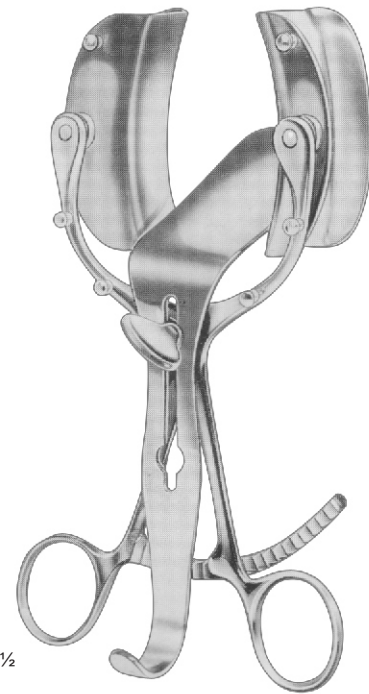

1/2 Legueu
S14.508.00

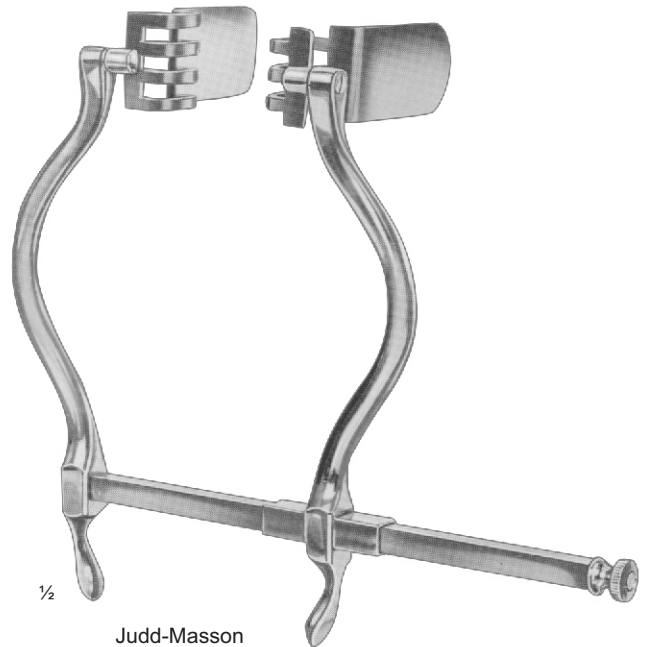

1/2 Judd-Masson
S14.509.00

- S14.503.00 - Bladder Retractors, self-retaining, with 4 detachable blades, centre spatula and retractor
- S14.508.00 - ditto, with 2 detachable blades and centre spatula
- S14.509.00 - ditto, for suprapubic prostatectomy, with 2 swivel blades

- Blasen-Wundspreizer, selbsthaltend, mit 4 abnehmbaren Blättern, Medialspatel und wundhaken
- ditto, mit 2 beweglichen Blättern und Medialspatel
- ditto, für suprapubische Prostatektomie, mit 2 drehbaren Blättern

- Separador vesical, de retención automática, con 4 valvas desmontables, 1 espátula central y depresor
- idem, con 2 valvas desmontables y espátula central
- idem, para prostatectomía suprapubiana con 2 valvas móviles

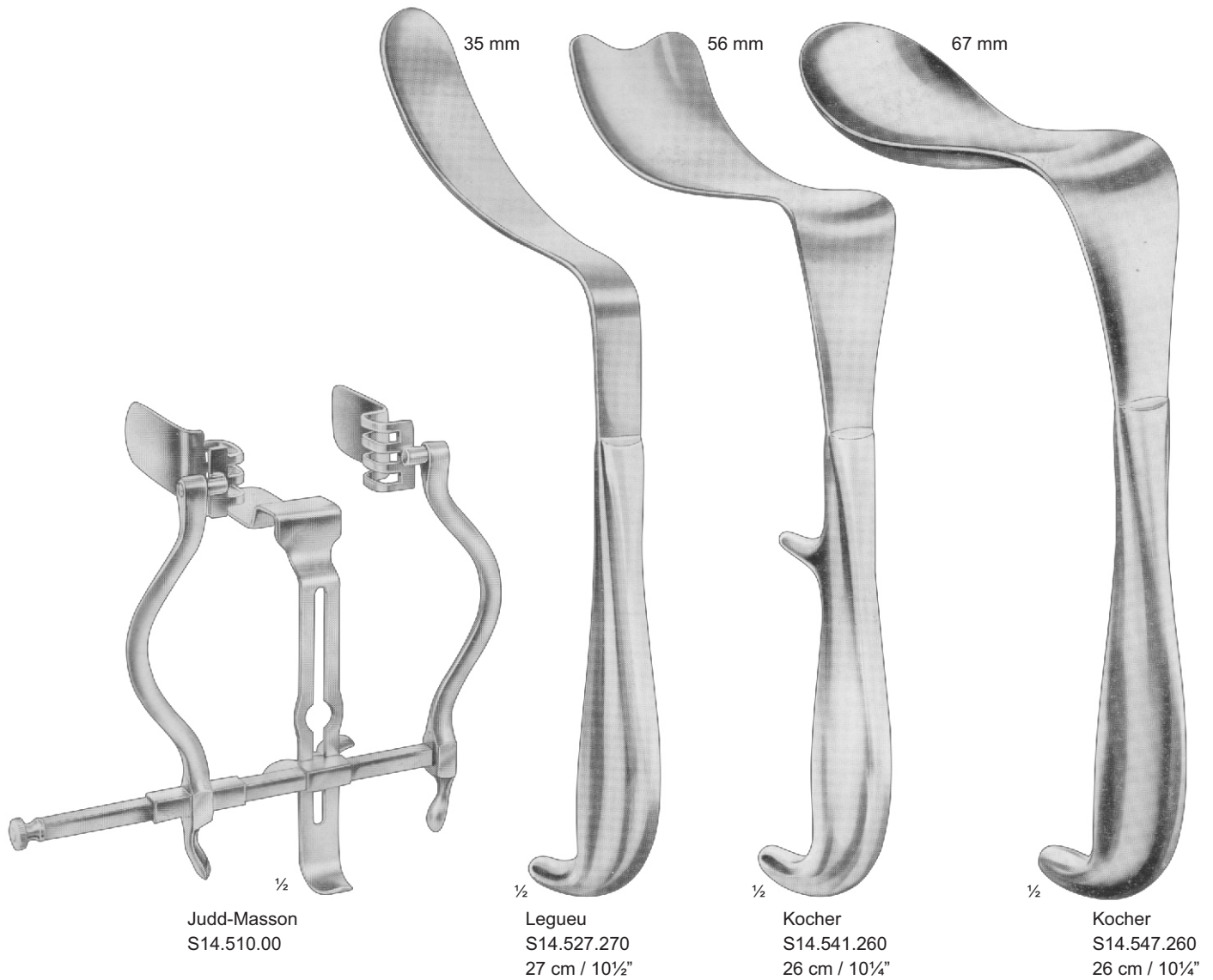

S14.510.00

- Bladder Retractor with 2 swivel blades and centre spatula

Blasenwundspreizer mit 2 drehbaren Blättern und Medialspatel

- Separador vesical con 2 valvas y espátula central



Table of measurements
Maßtabelle
Tabla de medidas

Scale I
Charrière (French) No. 8- 36,
rising by 1/3 mm per number

Scale II
Béniqué No. 20 - 26, rising
by 1/3 mm per two number

Skala I
Charrière No. 8 - 36,
um je 1/3 mm steigend

Skala II
Béniqué No. 20 - 60,
um 1/3 mm per
2 Nummern steigend

Escala I
Charrière no. 8 - 36
aumentándose en 1/3 mm
por número

Escala II
Béniqué no. 20 - 26
aumentándose en 1/3 mm
por dos números

Scale Skala Escala mm Ø	I charrière (French)	II Béniqué	Dittel	van Buren curved gebogen curvasa	Guyon without int. thread ohne Innen- gewinde sin rosca interior	Guyon with int. thread mitt Innen- gewinde con rosca interior
2 2/3	8		S14.580.08	S14.599.08		
3	9		S14.580.09			
3 1/3	10	20	S14.580.10	S14.599.10	S14.605.10	S14.607.10
3 2/3	11	22	S14.580.11		S14.605.11	S14.607.11
4	12	24	S14.580.12	S14.599.12	S14.605.12	S14.607.12
4 1/3	13	26	S14.580.13		S14.605.13	S14.607.13
4 2/3	14	28	S14.580.14	S14.599.14	S14.605.14	S14.607.14
5	15	30	S14.580.15		S14.605.15	S14.607.15
5 1/3	16	32	S14.580.16	S14.599.16	S14.605.16	S14.607.16
5 2/3	17	34	S14.580.17		S14.605.17	S14.607.17
6	18	36	S14.580.18	S14.599.18	S14.605.18	S14.607.18
6 1/3	19	38	S14.580.19		S14.605.19	S14.607.19
6 2/3	20	40	S14.580.20	S14.599.20	S14.605.20	S14.607.20
7	21	42	S14.580.21		S14.605.21	S14.607.21
7 1/3	22	44	S14.580.22	S14.599.22	S14.605.22	S14.607.22
7 2/3	23	46	S14.580.23		S14.605.23	S14.607.23
8	24	48	S14.580.24	S14.599.24	S14.605.24	S14.607.24
8 1/3	25	50	S14.580.25		S14.605.25	S14.607.25
8 2/3	26	52	S14.580.26	S14.599.26	S14.605.26	S14.607.26
9	27	54	S14.580.27		S14.605.27	S14.607.27
9 1/3	28	56	S14.580.28	S14.599.28	S14.605.28	S14.607.28
9 2/3	29	58	S14.580.29		S14.605.29	S14.607.29
10	30	60	S14.580.30	S14.599.30	S14.605.30	S14.607.30
10 2/3	32			S14.599.32		
10 1/3	34			S14.599.34		
12	36			S14.599.36		



	Dittel 6 - 10 mm 18 - 30 Charrière	Dittel Charrière (French) No. 8-30	van Buren Charrière (French) No. 8-36	Guyon Charrière No. 10-30	Guyon Charrière No. 10-30	Filiform S14.610.12
Set Satz Juego		S14.580.00	S14.599.00	S14.605.00	S14.607.00	
single einzel individ	S14.578.00	S14.580.08 - S14.580.30	S14.599.08 - S14.599.36	S14.605.10 - S14.605.30	S14.607.10 - S14.607.30	

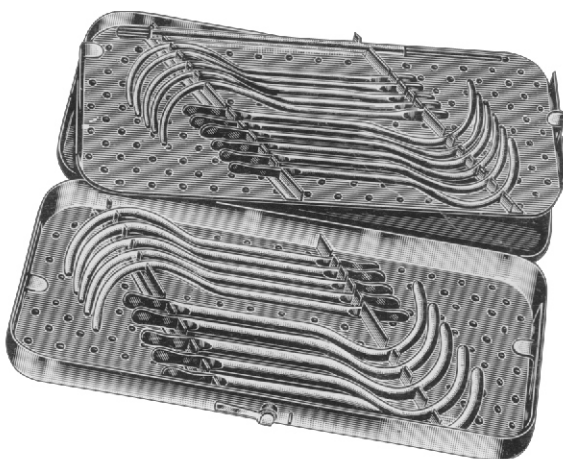

S14.612.00 Set in metal case, Containing:
 21 Bougies, Guyon S14.607.10 - S14.607.30
 6 filiform bougies S14.610.12 in metal tube

S14.612.00 Besteck, in Metalletui, enthaltend:
 21 Bougies, Guyon No. S14.607.10 - S14.607.30
 6 Gleitsonden No. S14.610.12 in Metallröhre

S14.612.00 Juego en estuche de metal, conteniendo:
 21 bujías Guyon S14.607.10 - S14.607.30
 6 bujías conductoras S14.610.12 en tubo de metal

Guyon
 S14.612.00
 420 x 175 x 40 mm

S14.578.00	- Dialting Sound, graduated in mm (diameter), from 6 to 10 mm	Bougie, Konisch, mit mm-Ø-Einteilung von 6-10 mm Ø	- Bujía dilaradora, graduada en mm (diámetro), de 6 a 10 mm
S14.605.10 - S14.605.30	- Urethral Dilating Sounds, without interior thread	Harnröhren-Bougies, ohne Innegevinde an Spitze	- Bujías dilatadoras uretrales, sin rosca interior
S14.610.12	- Filiform Bougie to be screwed on bougies S14.607.10 - S14.607.30	Gleitsonde (Filiformbougies), zum Aufschrauben auf Bougies No. S14.607.10 - S14.607.30	- Bujía conductora (bujía filiforme) atornillándose sobre las bujías dilatadoras S14.607.10 - S14.607.30



Table of measurements
Maßtabelle
Tabla de medidas

Scale Skala Escala mm Ø	I Charrière (French)			
2	6	S14.701.06	S14.721.06	S14.722.06
2 1/3	7	S14.701.07	S14.721.07	S14.722.07
2 2/3	8	S14.701.08	S14.721.08	S14.722.08
3	9	S14.701.09	S14.721.09	S14.722.09
3 1/3	10	S14.701.10	S14.721.10	S14.722.10
3 2/3	11	S14.701.11	S14.721.11	S14.722.11
4	12	S14.701.12	S14.721.12	S14.722.12
4 1/3	13	S14.701.13	S14.721.13	S14.722.13
4 2/3	14	S14.701.14	S14.721.14	S14.722.14
5	15	S14.701.15	S14.721.15	S14.722.15
5 1/3	16	S14.701.16	S14.721.16	S14.722.16
5 2/3	17	S14.701.17	S14.721.17	S14.722.17
6	18	S14.701.18	S14.721.18	S14.722.18
6 1/3	19	S14.701.19	S14.721.19	S14.722.19
6 2/3	20	S14.701.20	S14.721.20	S14.722.20
7	21	S14.701.21	S14.721.21	S14.722.21
7 1/3	22	S14.701.22	S14.721.22	S14.722.22
7 2/3	23	S14.701.23	S14.721.23	S14.722.23
8	24	S14.701.24	S14.721.24	S14.722.24

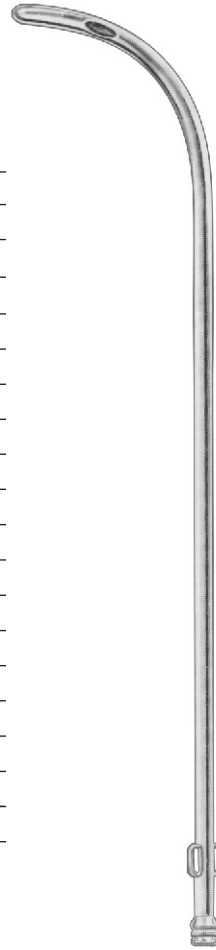

S14.701.06 -
S14.701.24
Charrière (French)
No. 6 - 24
27 cm / 10 1/2"

S14.721.06 -
S14.721.24
Charrière (French)
No. 6 - 24
15 cm / 6"

Catheter (S-Shape)
S14.722.06 -
S14.722.24
Charrière (French)
No. 6 - 24
20 cm / 8"

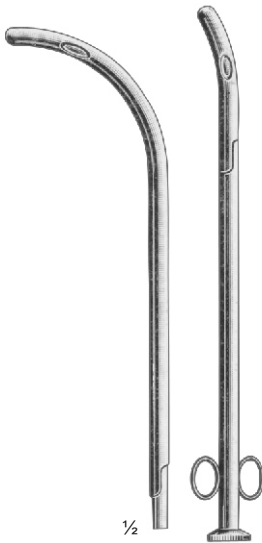

S14.725.00

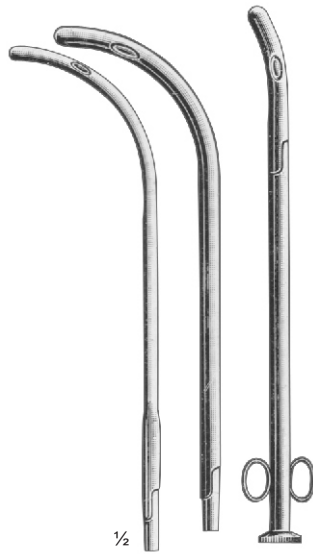

S14.727.00

S14.701.06 - S14.701.24
S14.721.06 - S14.721.24

- Male catheters
- Female Catheters
Combined, for pocket sets

für Männer
für Frauen
Zum Zusammenschrauben, für
Taschenbestecke,

- para hombres
- para mujeres
combinadas, para juegos de bolsillo

S14.725.00
S14.727.00

- male and female
- male, female and children's

für Männer und Frauen
für Männer, Frauen und Kinder

- para hombres y mujeres
- para hombres, mujeres y niños

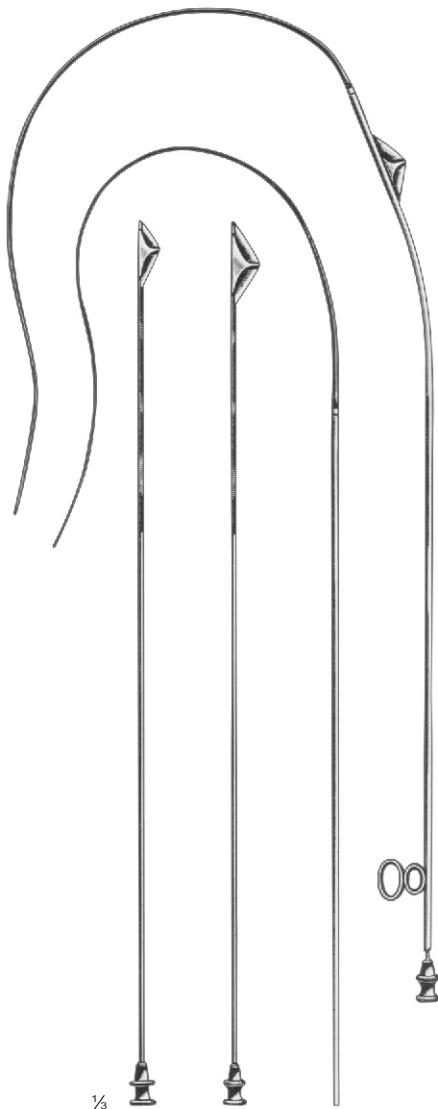

1/2
 Maisonneuve
 S14.755.00 - S14.757.00

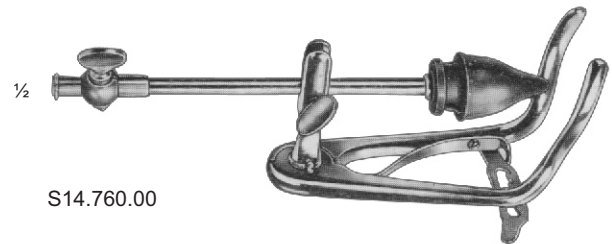

1/2
 S14.760.00

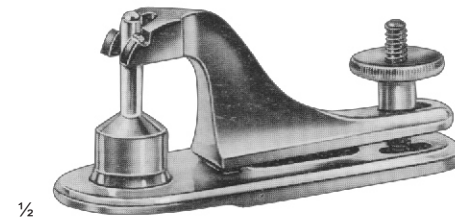

1/2
 S14.765.08 - S14.765.32

- S14.755.00 - Urethrotome, complete with 2 filiform guides, 1 stilette and 3 outward cutting blades
- S14.756.00 - ditto, but with 3 inward cutting blades
- S14.757.00 - Leather case for S14.755.00 - S14.756.00
- S14.760.00 - Knutson Urethrography Instrument, consisting of holder, penile, adjustable, with sliding cannula with rubber cone
- Circumcision Instrument
- S14.765.08 - 8 mm Ø, baby size
- S14.765.11 - 11 mm Ø, child size
- S14.765.13 - 13 mm Ø, child size
- S14.765.16 - 16 mm Ø, adolescent size
- S14.765.21 - 21 mm Ø, adolescent size
- S14.765.26 - 26 mm Ø, men's size
- S14.765.32 - 32 mm Ø, men's size

- Uretrotom, komplett mit 2 Gleitsonden (Filiformbougies), 1 Stilet und 3 auswärts gestellten Messern
- ditto, jedoch mit 3 einwärts gestellten Messern
- Leder tasch e für S14.755.00 - S14.756.00
- Knutson Urethrographie -Instrument, bestehend aus verstellbarer penishalterung mit verschiebbarer Kanüle mit Gummikonus
- Circumcisionsgerät
- 8 mm Ø, für Säuglinge
- 11 mm Ø, für Knaben
- 13 mm Ø, für Knaben
- 16 mm Ø, für Jugendliche
- 21 mm Ø, für Jugendliche
- 26 mm Ø, für Männer
- 32 mm Ø, für Männer

- Uretrótomos, completo con 2 bujías conductoras, 1 estilete y 3 hojas cortantes al exterior
- idem, pero con 3 hojas cortantes al interior
- Funda de piel para S14.755.00 - S14.756.00
- Knutson instrumento de uretrografía, compuesto de soporte para el penis ajustable, con cánula regulable con cono de goma
- Instrumento para circuncisión
- 8 mm Ø. para bebés
- 11 mm Ø, para niños
- 13 mm Ø, para niños
- 16 mm Ø, para adolescentes
- 21 mm Ø, para adolescentes
- 26 mm Ø, para hombres
- 32 mm Ø, para hombres

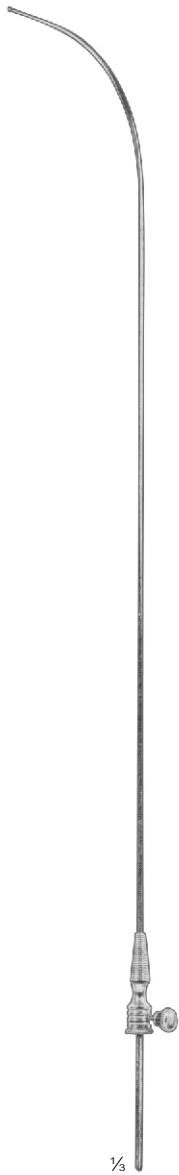

S14.785.460
46 cm / 18"



S14.787.460
46 cm / 18"

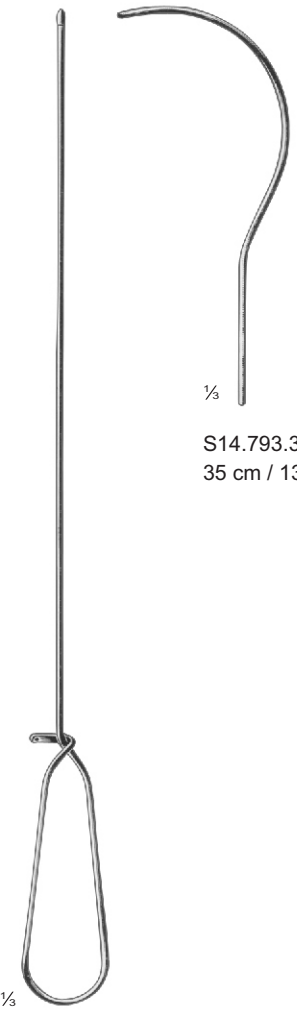

Guyon
S14.792.390
39 cm / 15½"

1/3

S14.793.350
35 cm / 13¾"

- S14.785.460 - Mandrin for rubber catheters, with Dittel curve, adjustable cone
- S14.787.460 - ditto, with Guyon curve
- S14.792.390 - ditto, straight
- S14.793.350 - ditto, curved

- Einführungsinstrument (Katheterspanner), mit Dittelbiegung, Konus verstellbar
- ditto, mit Guyonbiegung
- ditto, gerade
- ditto, gebogen

- Mandril para sondas de goma blanda, con curva de Dittel, con cono ajustable
- idem, con curva de Guyon
- idem, recto
- idem, curvo

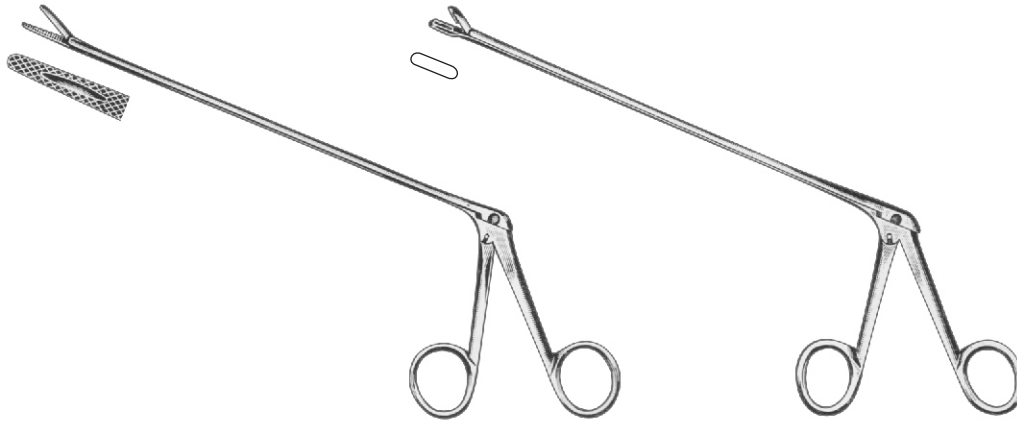

Lengths of shafts Schäftlängen Largos de las astas		Mathieu	Mathieu
20 cm	8"	S14.811.200	S14.813.200
28 cm	11"	S14.811.280	S14.813.280

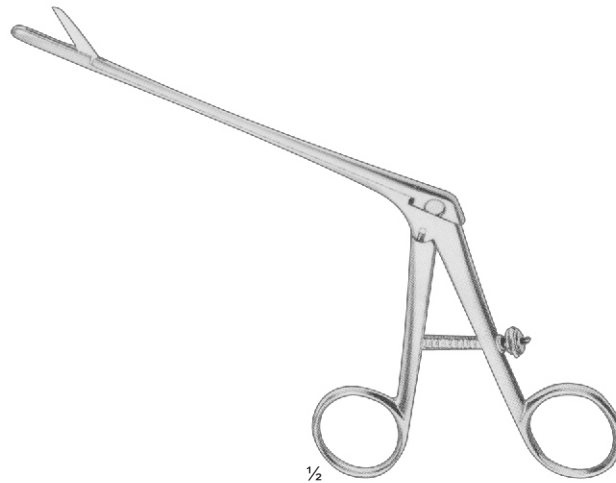

1/2 Sachse
 S14.817.12

S14.811.200 - S14.811.280
 S14.813.200 - S14.813.280
 S14.817.12

- Urethral Foreign Body Forceps
 serrated jaws
 - ditto, sharp, punch jaws
 - Meatotome

Fremdkörperzange, für die Harnröhre,
 gerieftes Maul
 dito, scharf, durchschneidend
 Meatotom

- Pinza uretral para cuerpos
 extraños, boca estriada
 - idem, sacabocado
 - Meatótomo

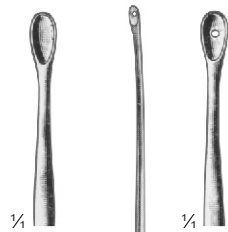

¼

¼

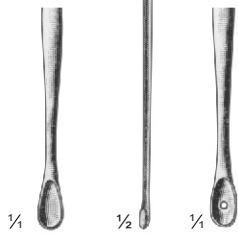

¼

½

¼

Guttmann
S14.840.265 - S14.842.265
26.5 cm / 10½"

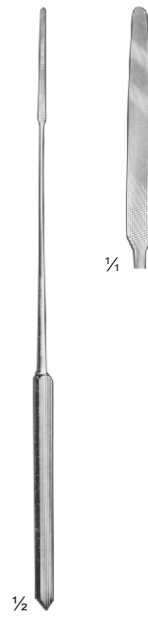

½

¼

S14.850.160
16 cm / 6¼"



½

Jusbasic
S14.873.190
19 cm / 7½"



½

Stockmann
S14.875.08



½

Stockmann
S14.877.08

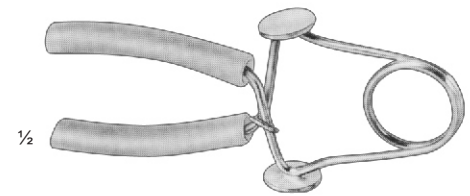

½

Strauss
S14.881.11

- S14.840.265
- S14.842.265
- S14.850.160
- S14.873.190
- S14.875.08
- S14.877.08
- S14.881.11

- Secretion Scoops flexible, may be held in the open flame
- without holes
- with holes
- Secretion Spatula, for urethral specimen taking
- Penis seizing Forceps
- Meatus Clamp
- ditto, with catch
- ditto, rubber covered

- Sekretlöffel, biegsam, ausglühbar ohne Löcher
- mit Löchern
- Sekretspatel, für Harnröhrenabstriche
- Penisfaßzange
- Penisklemme
- ditto, mit Raste
- ditto, mit Gummibelag

- Cucharillas para secreciones, flameables
- sin agujeros
- con agujeros
- Espátula de secreción para frotos uretrales
- Pizas para coger el penis
- Compresor uretral
- idem, con trinquete
- idem, forrado de goma blanda



acme surgical
www.acmesurgical.com