

13

Intestines, Stomach, Rectum
Darm, Magen, Mastdarm
Intestinos, Estómago, Recto

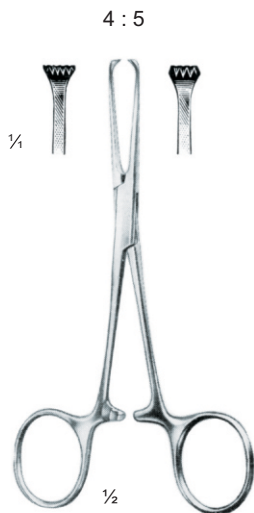

acme surgical
www.acmesurgical.com



Allis-Baby
S13.130.120
12 cm / 4 1/2"
4 : 5 teeth . Zähne . dientes



Allis		4 : 5	5 : 6
cm.	in.	4 : 5	5 : 6
15	6"	S13.132.150	S13.134.150
16	6 1/4"		S13.134.160
18	7"		S13.134.180
19	7 1/2"		S13.134.190
20	8"		S13.134.200
25	10"		S13.134.250



Allis-Adair
S13.138.150
15.5 cm / 6"
10 : 11 teeth . Zähne . dientes



Boys-Allis
S13.142.150
15 cm / 6"



Lockwood-Allis
S13.146.160 = 16 cm / 6 1/4"
S13.146.120 = 20 cm / 8"



Judd-Allis
S13.148.150 = 15 cm / 6"
S13.148.190 = 19 cm / 7"



Thoms-Allis
 S13.150.200
 20 cm / 8"



Allis
 S13.154.200
 20 cm / 8"

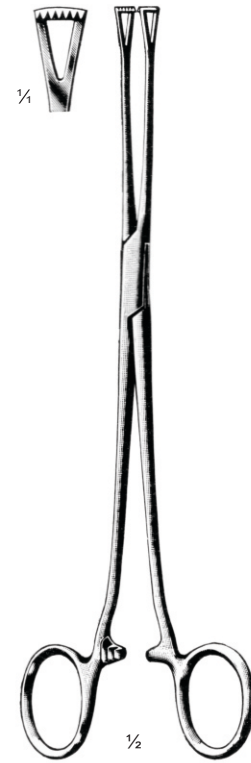

Lockwood
 S13.170.200
 20 cm / 8"



Williams
 S13.186.160
 16 cm / 6 1/4"



Babcock
 S13.190.160 = 16 cm / 6 1/4"
 S13.190.200 = 20 cm / 8"

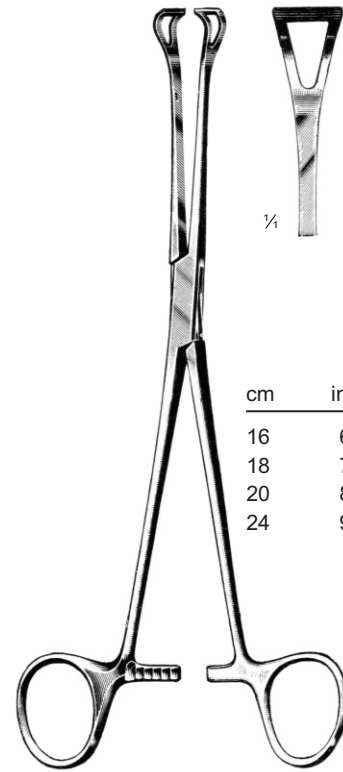

Babcock

cm	in.	
16	6 1/4	S13.192.160
18	7	S13.192.180
20	8	S13.192.200
24	9 1/2	S13.192.240

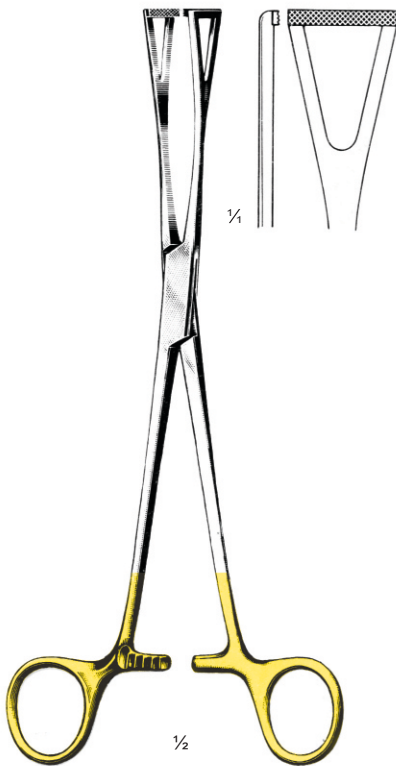

Duval
S13.206.200
20 cm / 8"

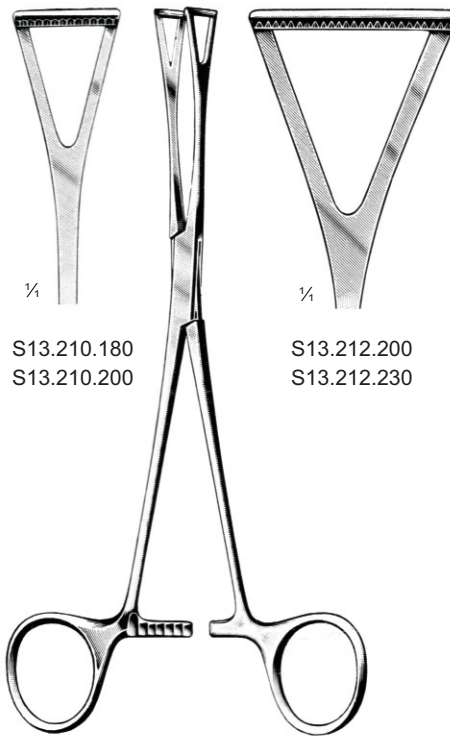

S13.210.180
S13.210.200

S13.212.200
S13.212.230

	cm	in.		cm	in.
S13.210.180	18	7	S13.212.200	20	8
S13.210.200	20	8	S13.212.230	23	9



1/4
S13.230.00
pair
Paar
par

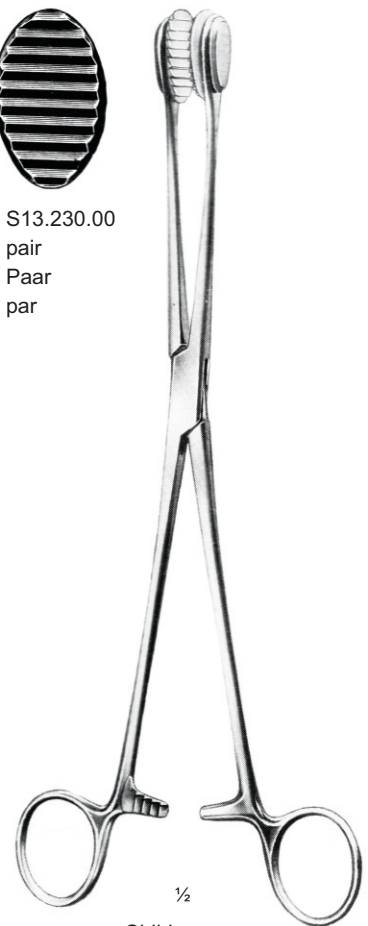

Child
S13.228.240
24 cm / 9 1/2"

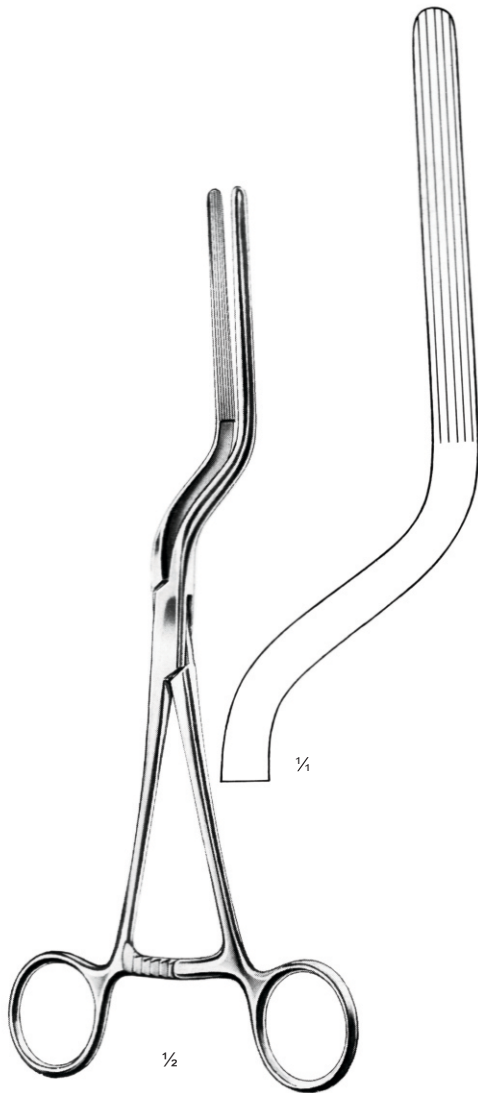

Brunner
S13.265.240
24 cm / 9½"

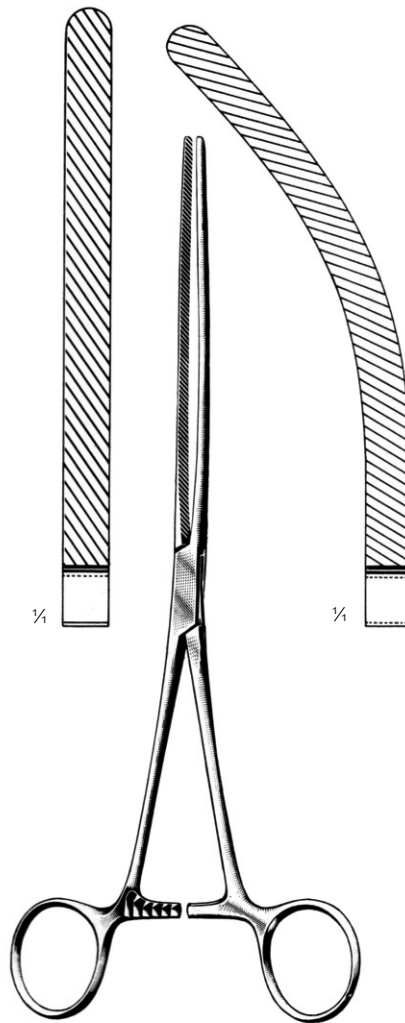

Doyen

	straight gerade rectas		curved gebogen curvas
	cm	in.	
S13.274.210	21	8¼	S13.275.210
S13.274.230	23	9	S13.275.230

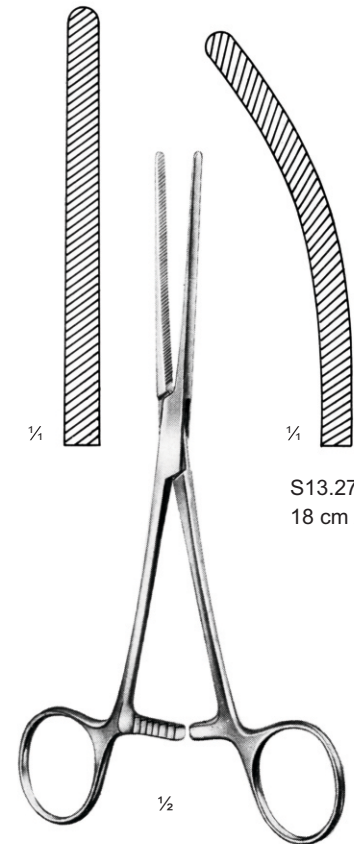

Baby-Doyen
S13.276.180
18 cm / 7"

S13.277.180
18 cm / 7"

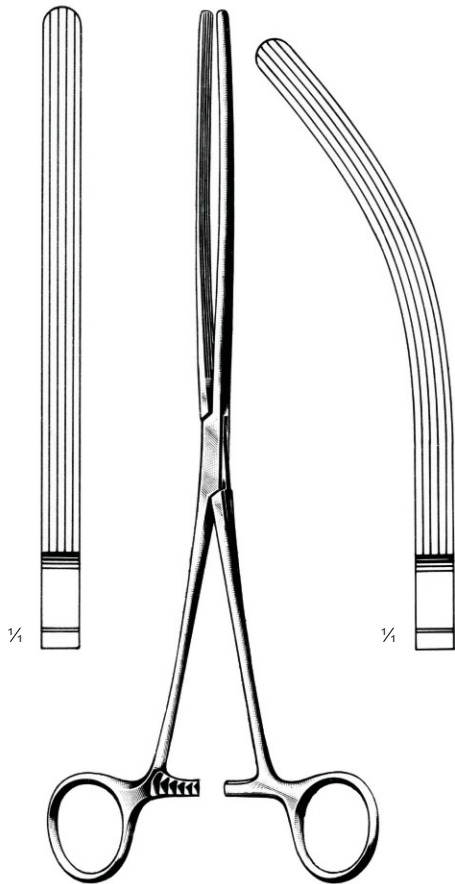

Mayo-Robson

straight gerade rectas	cm	in.	curved gebogen curvas
S13.286.210	21	8 ¹ / ₄	S13.287.210
S13.286.230	23	9	S13.287.230

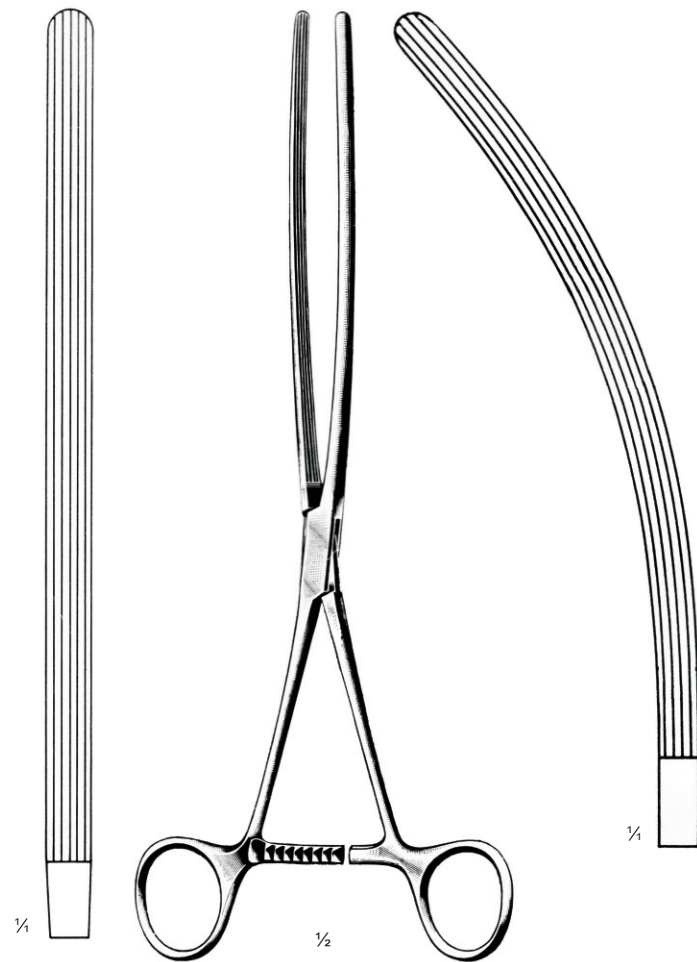

Mayo-Robson

straight gerade rectas	cm	in.	curved gebogen curvas
S13.288.250	25	10	S13.289.250



Kocher
very elastic . sehr elastisch . muy elásticas

straight gerade rectas	cm	in.	curved gebogen curvas
S13.304.220	22	8 $\frac{3}{4}$	S13.305.220
S13.304.250	25	10	S13.305.250
S13.304.280	28	11	S13.305.280

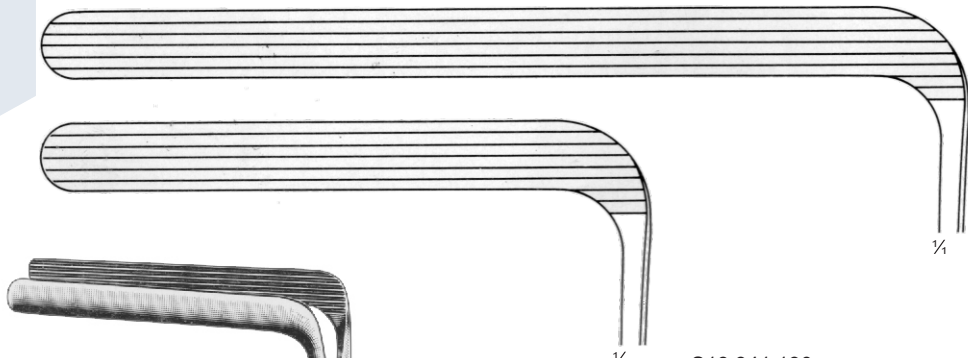

S13.343.190

S13.341.190

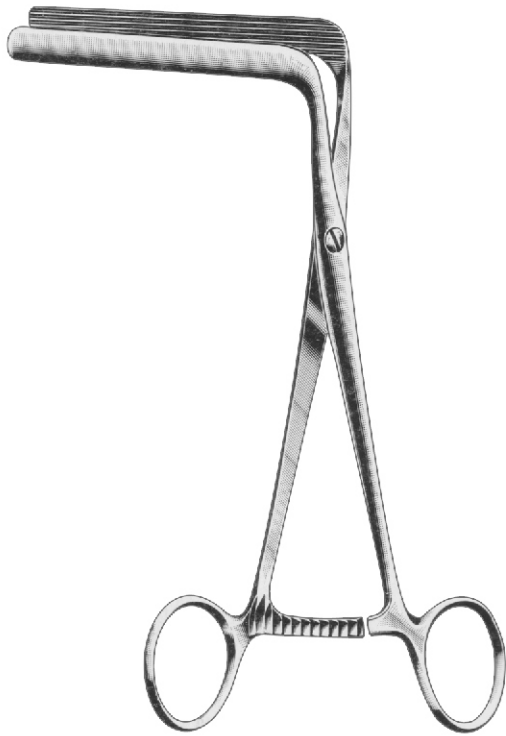

Mikulicz
19 cm / 7½"

Jaw length
Maullänge
Largo de boca

cm	in.	
8	3¼	S13.341.190
12	4¾	S13.343.190

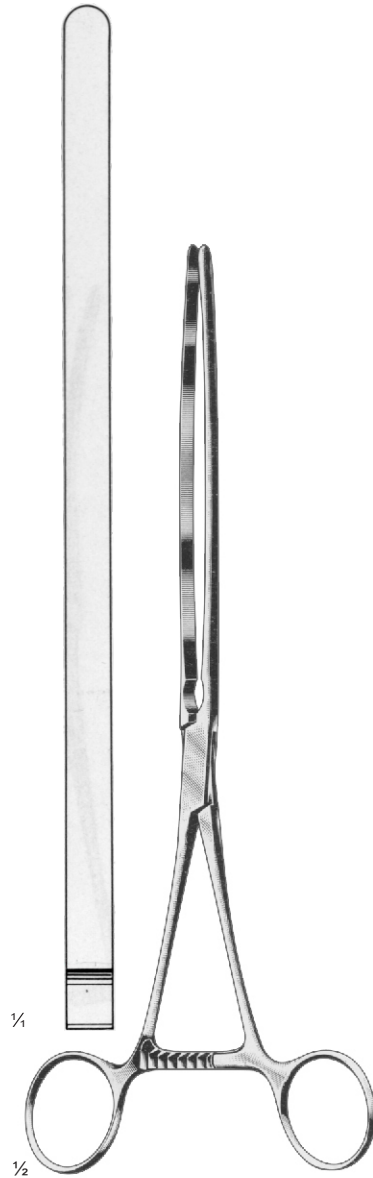

Scudder
S13.352.250
25 cm / 10"

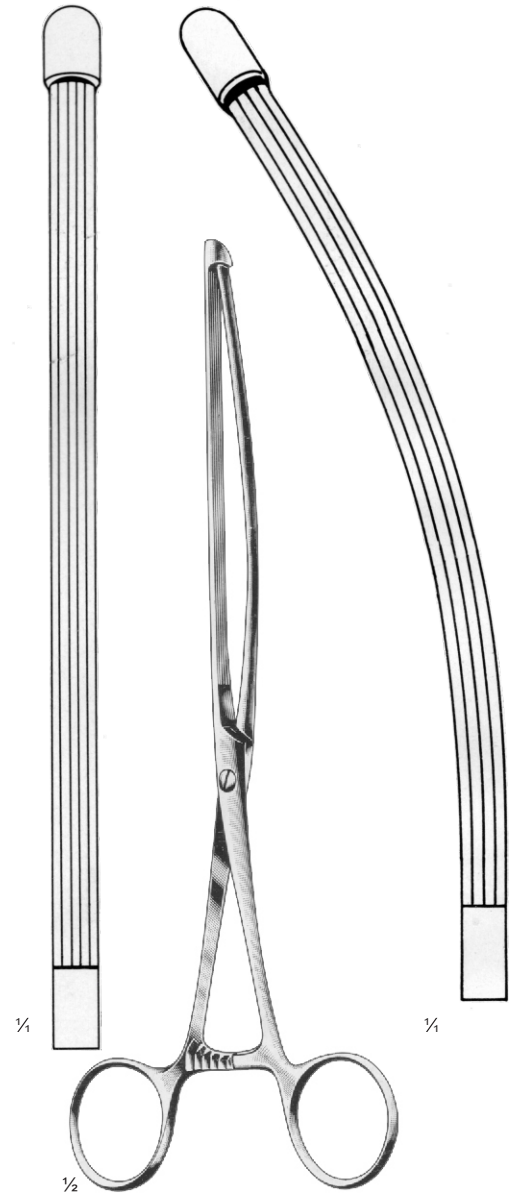

Nussbaum straight gerade recta	cm	in.	curved gebogen curva
S13.360.250	25	10	S13.361.250

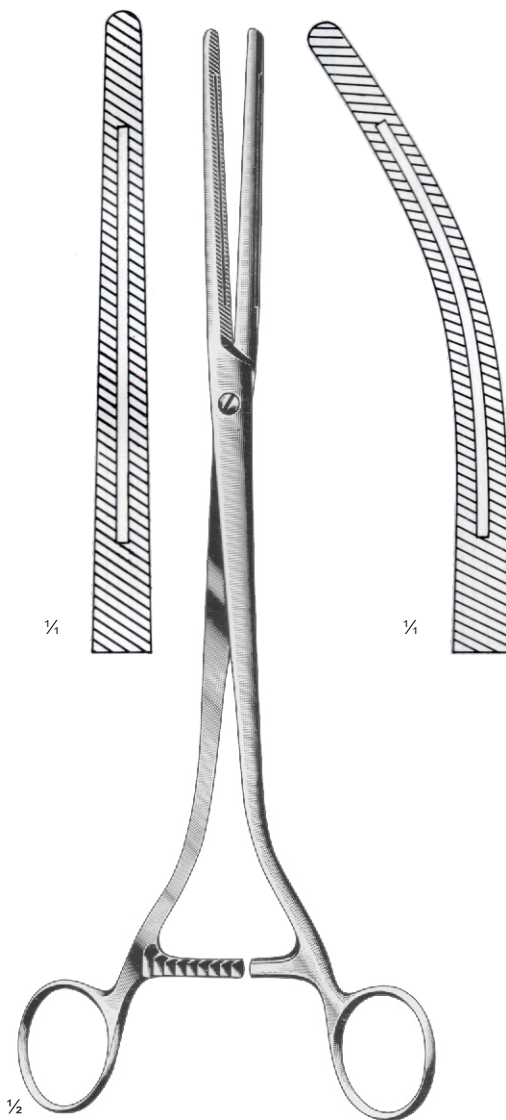

Moynihan

	straight gerade recta		curved gebogen curva
	cm	in.	
S13.368.290	29	11½	S13.369.290

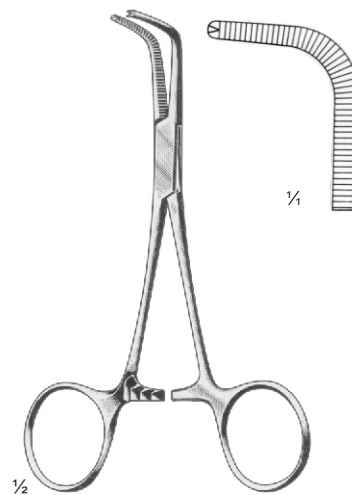

Kleinschmidt
 S13.397.120
 12 cm / 4¾"

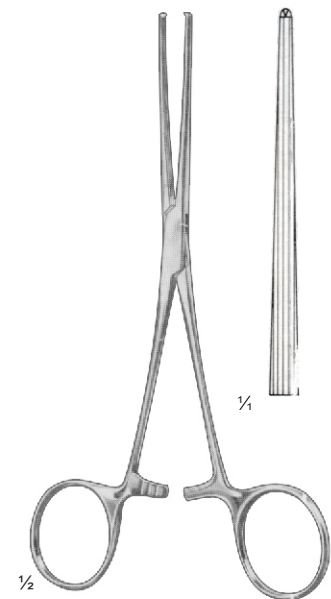

Allen
 S13.398.155
 15.5 cm / 6¼"

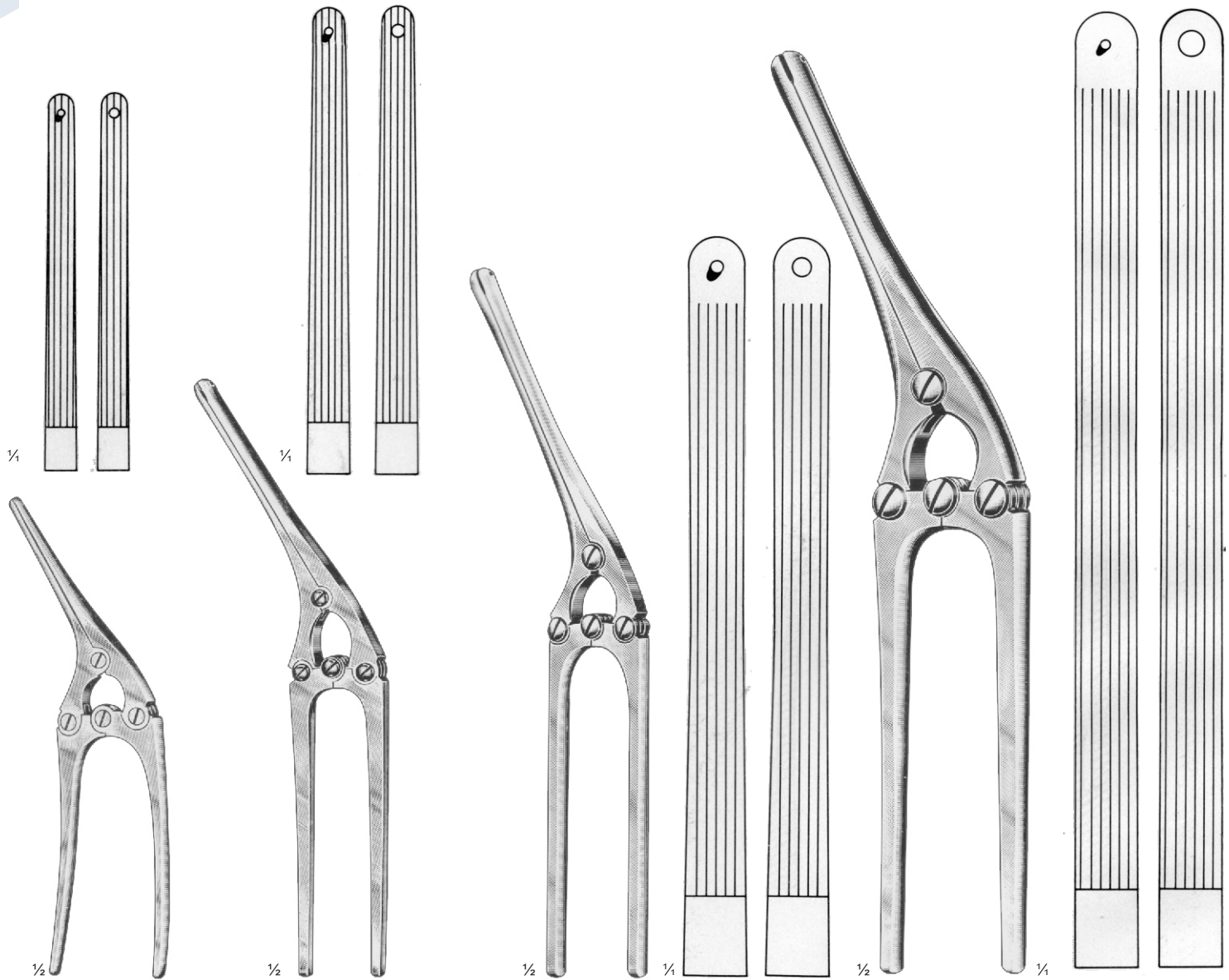

Payr-Baby
15 cm / 6"

Payr
21 cm / 8¼"

Payr
29 cm / 11½"

Payr
35 cm / 13¾"

without pin ohne stift sin espiga	with pin mit Stift con espiga	without pin ohne Stift sin espiga	with pin mit Stift con espiga
S13.413.150	S13.415.150	S13.417.210	S13.419.210

without pin ohne stift sin espiga	with pin mit Stift con espiga	without pin ohne Stift sin espiga	with pin mit Stift con espiga
S13.423.290	S13.425.290	S13.431.350	S13.433.350

S13.413.150 - S13.415.150

- Intestinal Crushing Clamps, for children

Darmquetschklemmen, für Kinder

- Pinzas enterótomos, para niños

S13.417.210 - S13.425.290
 S13.431.350 - S13.433.350

- Intestinal Crushing Clamps
 - Pylorus Clamps

Darmquetschklemmen
 Magenquetschklemmen

- Pinzas enterótomos
 - Pinzas aplastadoras para el estómago

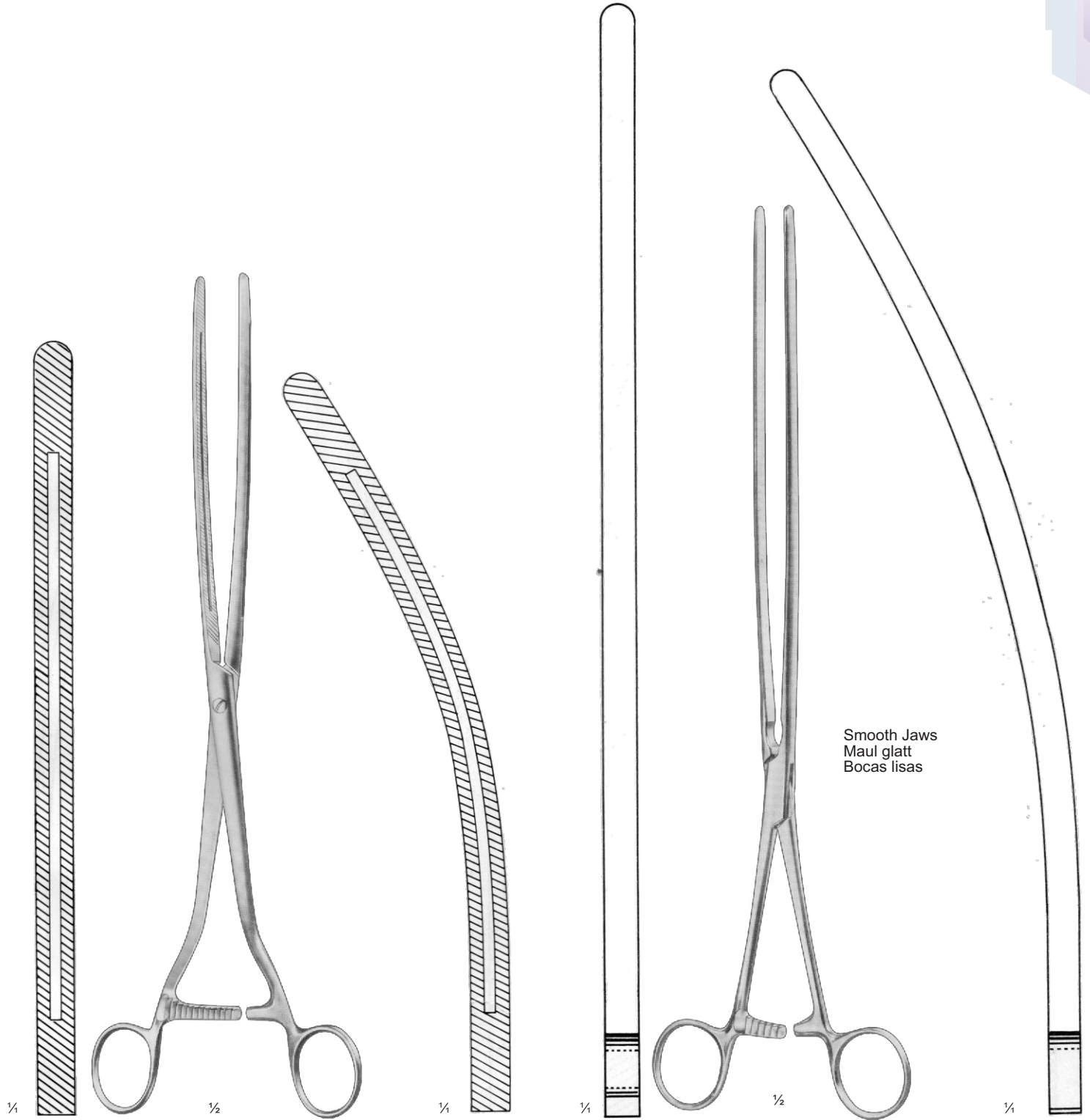

S13.442.310

Moynihan
31 cm / 12 1/4"

S13.443.310

S13.448.330

Scudder
33 cm / 13"

S13.449.330

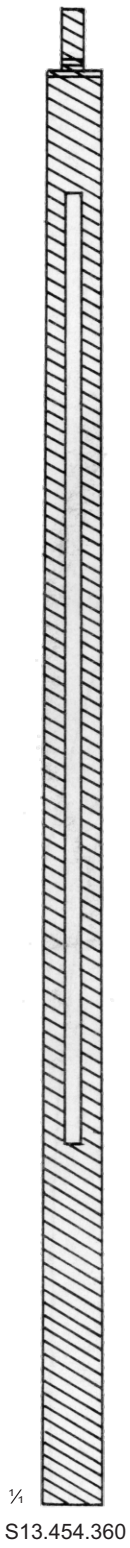

S13.454.360



Moynihan
36 cm / 14 1/4"

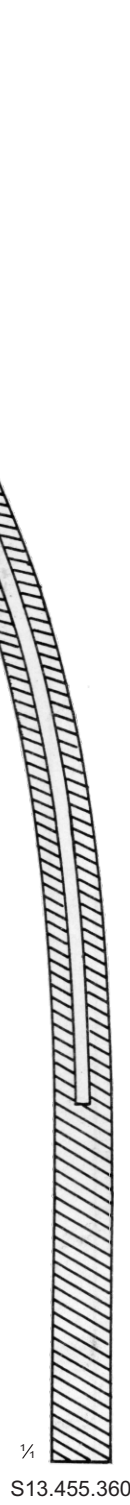

S13.455.360

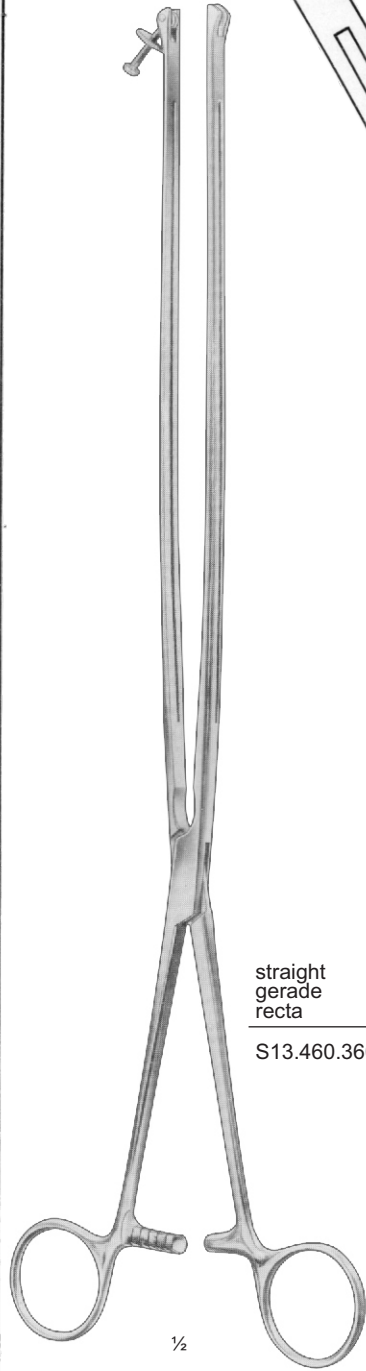

Scudder
36 cm / 14"

straight gerade recta	curved gebogen curva
S13.460.360	S13.461.360

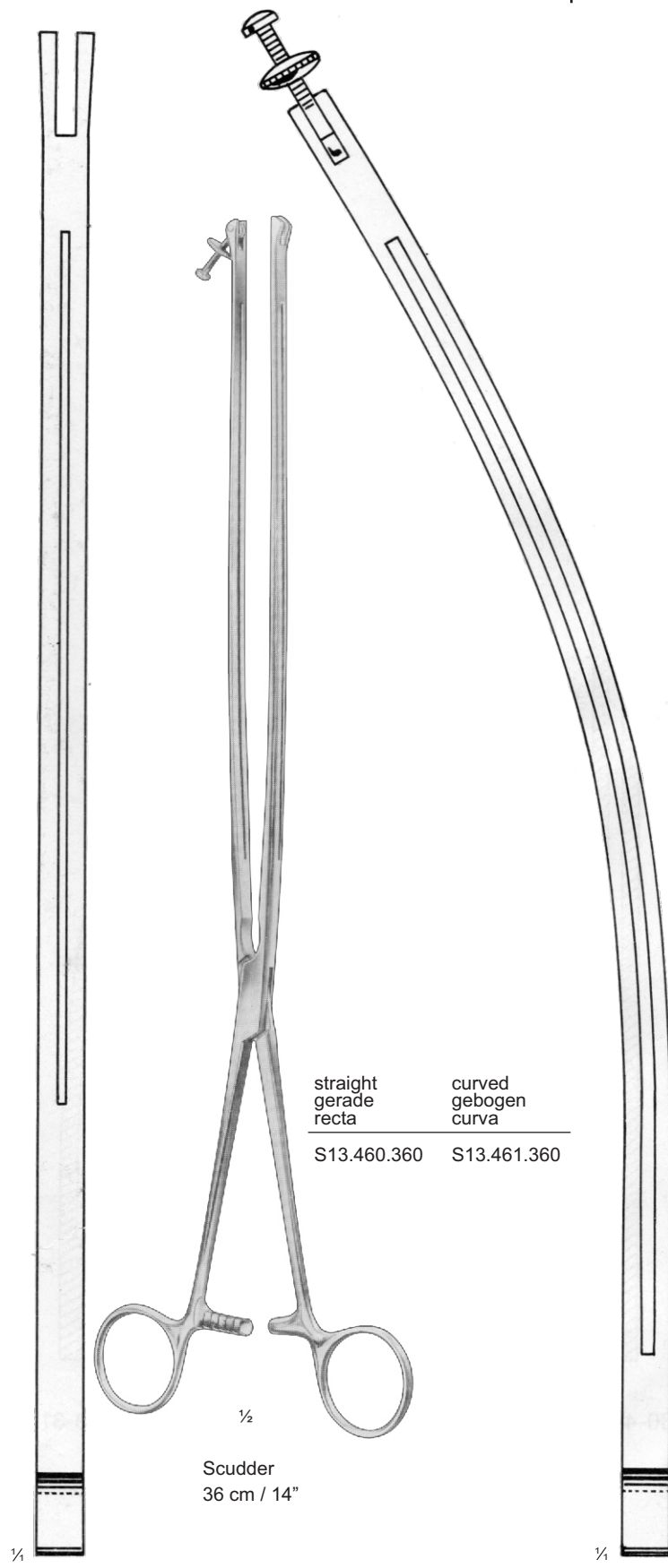



Lane
 S13.474.300
 30 cm / 12"

Lane
 S13.475.300
 30 cm / 12"

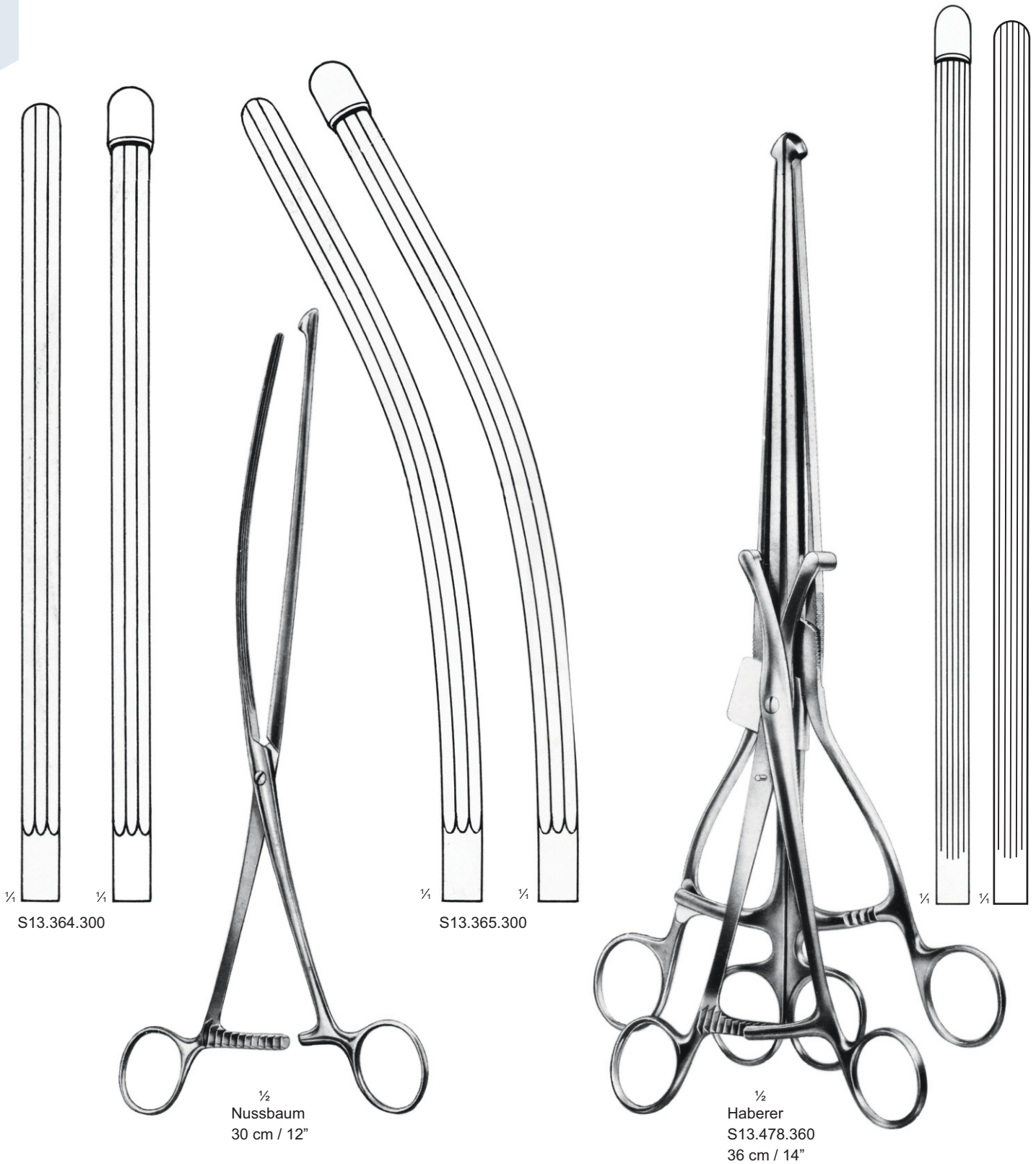

S13.478.360 | - Intestinal and Stomach Twin Clamp Forceps

Darm- und Magen-Zwillings-
klemme

- Pinza-clamp gemela para intestino y estómago

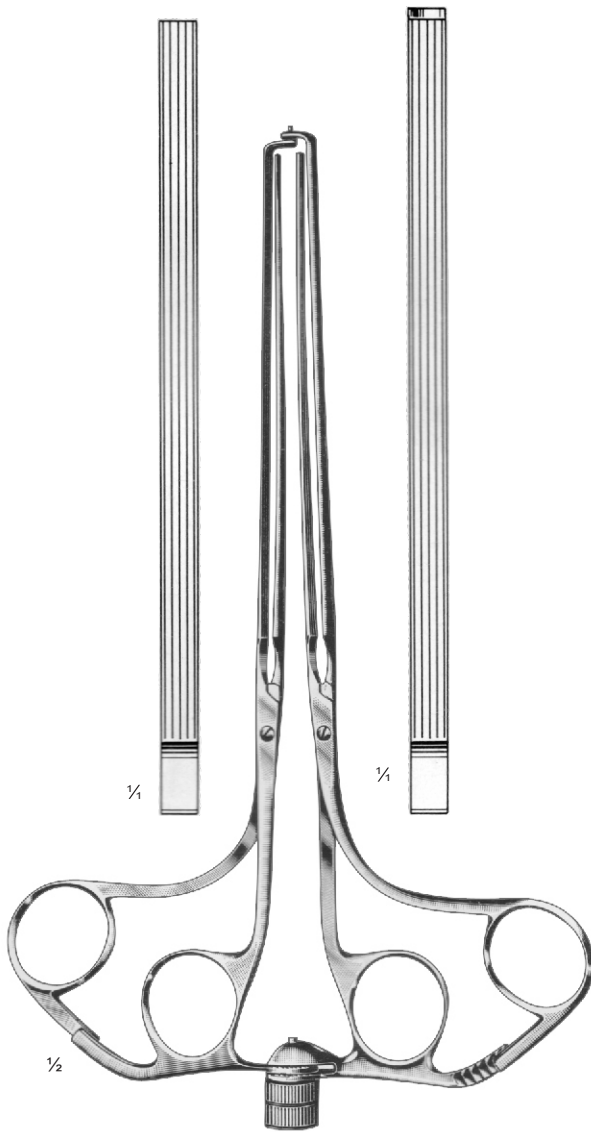

Abadie
S13.484.220 = 22 cm / 8³/₄"
S13.484.270 = 27 cm / 10¹/₂"

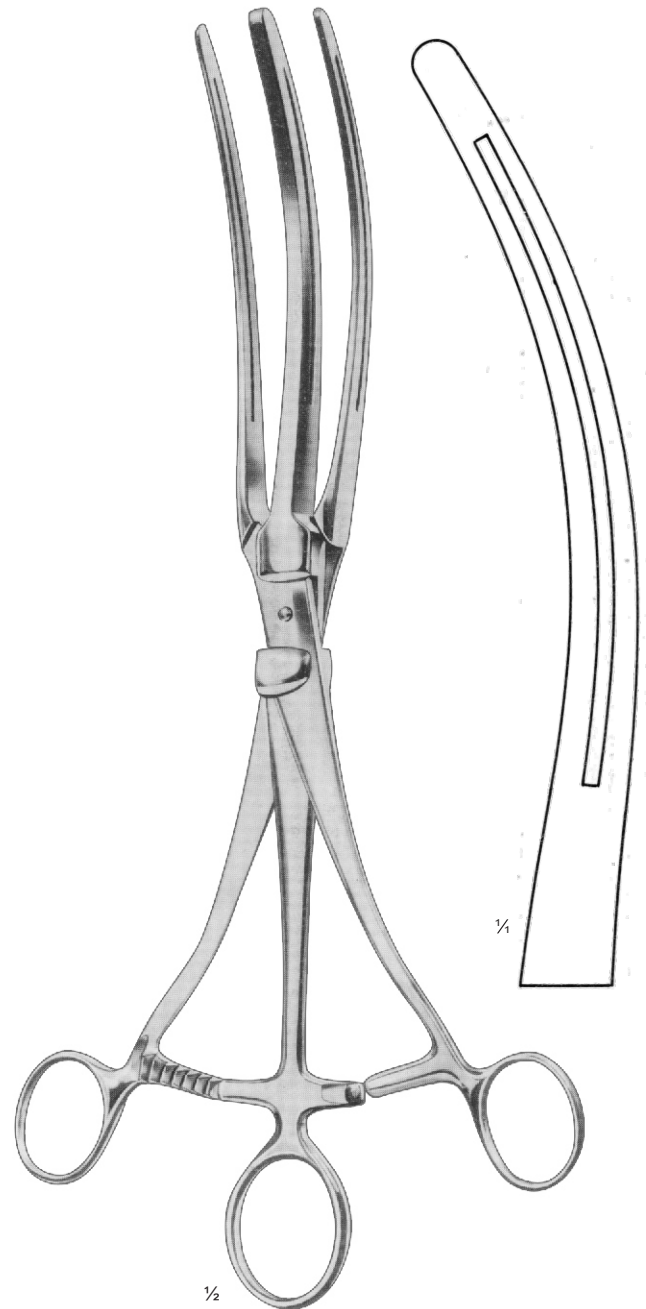

Roosevelt
S13.487.340
34 cm / 13¹/₂"

S13.484.220 | - Intestinal Twin Clamp Forceps
S13.484.270 | - Intestinal and stomach Twin Clamp Forceps

Darm-Zwillingsklemme
Darm- und Magen-Zwillings-
klemme

- Pinza-clamp gemela para intestino
- Pinza-clamp gemela para intestino y estómago

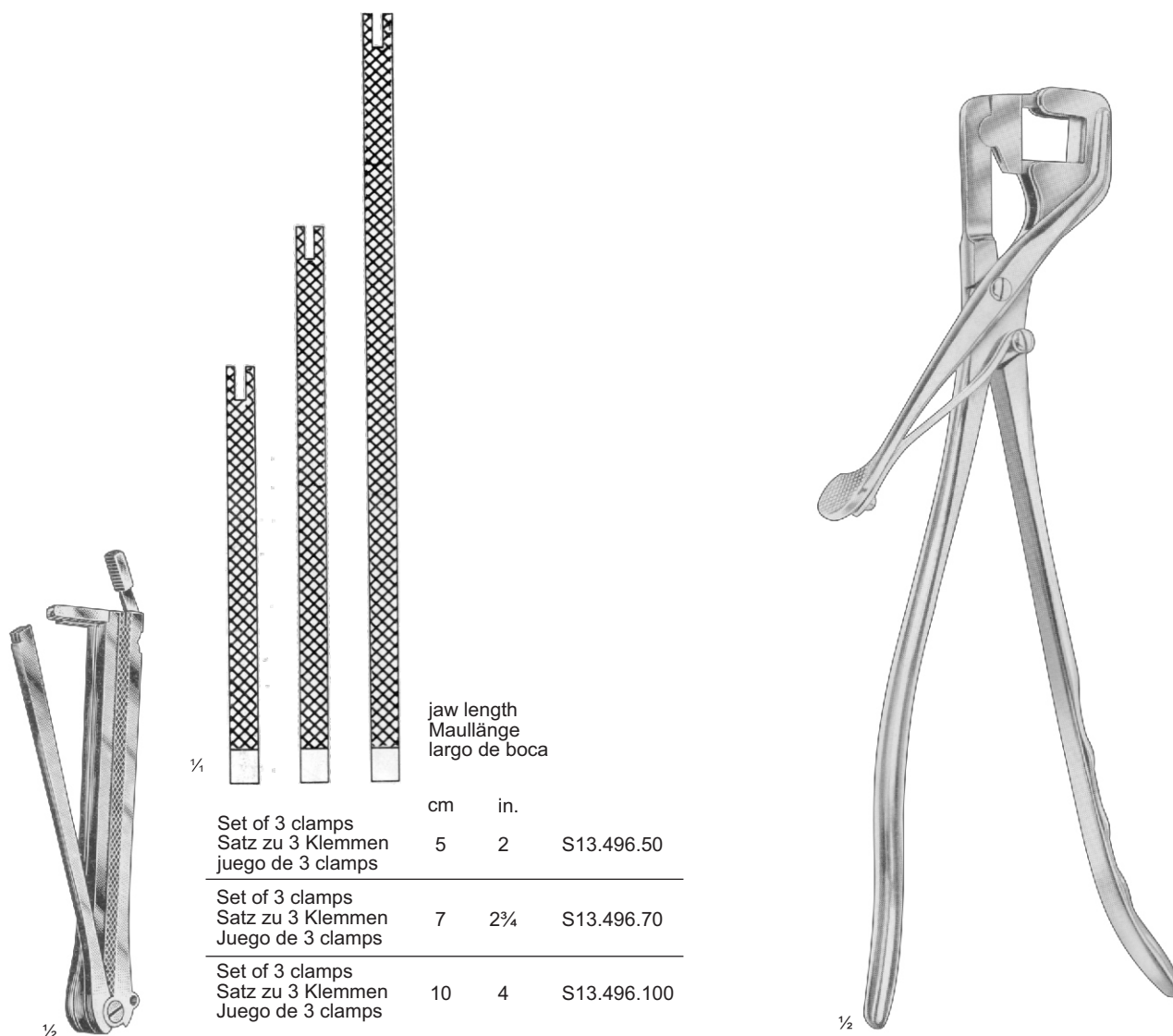

	jaw length Maullänge largo de boca		
	cm	in.	
Set of 3 clamps Satz zu 3 Klemmen juego de 3 clamps	5	2	S13.496.50
Set of 3 clamps Satz zu 3 Klemmen Juego de 3 clamps	7	2¾	S13.496.70
Set of 3 clamps Satz zu 3 Klemmen Juego de 3 clamps	10	4	S13.496.100

De Martel-Wolfson
S13.496.50 - S13.496.100

De Martel-Wolfson
S13.497.260
26 cm / 10¼"

S13.496.50 - S13.496.100
S13.497.260

- Anastomosis Clamps	Anastomosenklemmen	- Clamps para anastomosis
- Clamp Closing Forceps	klemmschließzange	- Pinza para cerrar los clamps

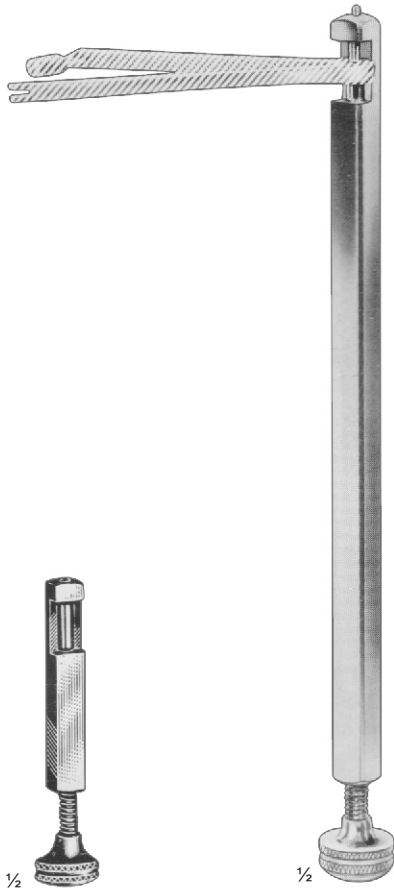

½

S13.498.85
8.5 cm / 3½"

½

De Martel-Wolfson
S13.498.230
23 cm / 9"



½

Stone-Watt
jaw length
Maullänge
largo de boca

cm	in.	
7.5	3	S13.520.75
10.0	4	S13.520.100



Stone-Watt
S13.522.00

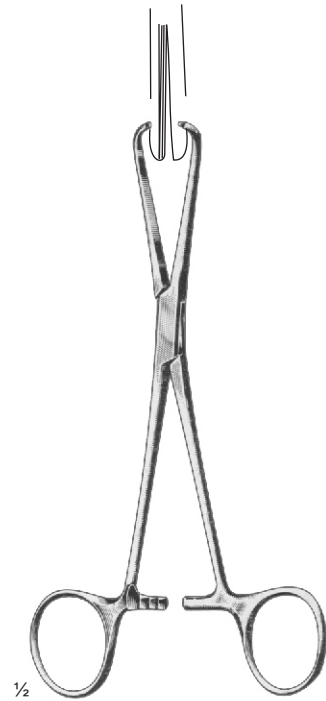

½

Stone
S13.524.155
15.5 cm / 6"

S13.498.85
S13.498.230
S13.520.75 - S13.520.110

S13.522.00
S13.524.155

- Clamp Holder, short
- ditto, long
- Intestinal (Anastomosis) Clamps with locking ferrule
- Locking ferrule only
- clamp Holding and Closing Forceps

Klemmenhalter, kurz
dito, lang
Darm-(Anastomos-) Klemmen
mit Schließchen,
Schließchen, allein
Verschluß- und Halteklemme

- Porta-clamp, corto
- idem, largo
- Clamps para intestino (anastomosis) con manguito de cierre
- Manguito de cierre, suelto
- Pinza para cerrar y sostener los clamps

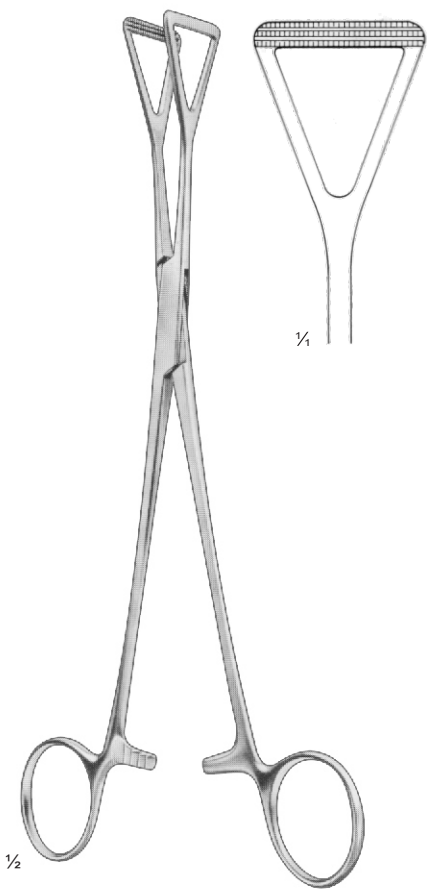

Scheibe
S13.540.230
23 cm / 9"

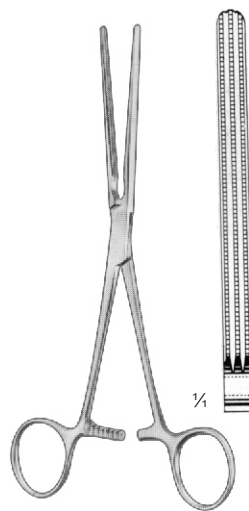

Baby-Doyen
S13.550.130 = 13 cm / 5 1/4"
S13.550.160 = 16 cm / 6 1/4"

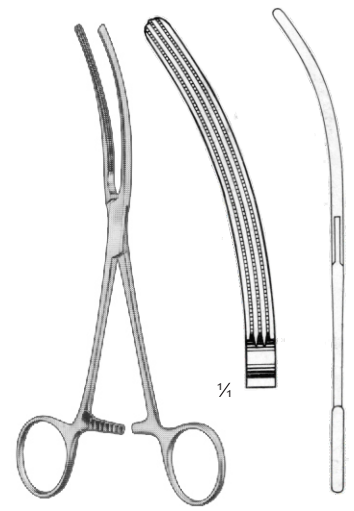

Baby-Doyen
S13.551.130 = 13 cm / 5 1/4"
S13.551.160 = 16 cm / 6 1/4"



Doyen-Atrauma
 S13.550.160 - S13.550.230

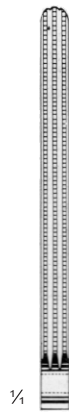

S13.550.160
 16 cm / 6¼"



S13.550.180
 18 cm / 7"

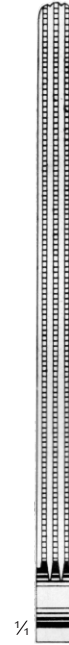

S13.550.215
 21.5 cm / 8½"

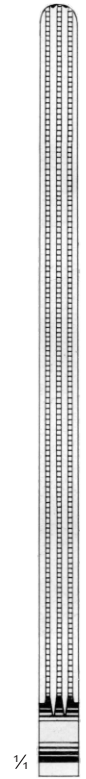

S13.550.230
 23 cm / 9"



Doyen-Atrauma
 S13.551.160 - S13.551.230

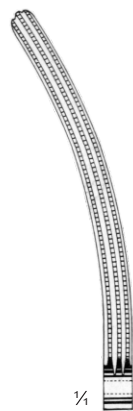

S13.551.160
 16 cm / 6¼"

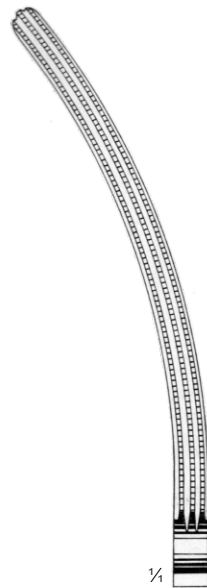

S13.551.180
 18 cm / 7"

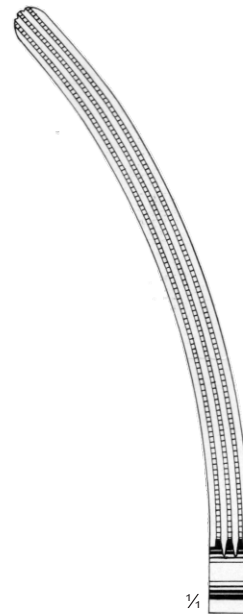

S13.551.215
 21.5 cm / 8½"

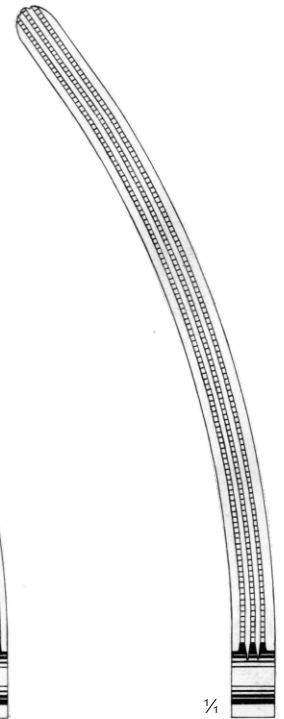

S13.551.230
 23 cm / 9"

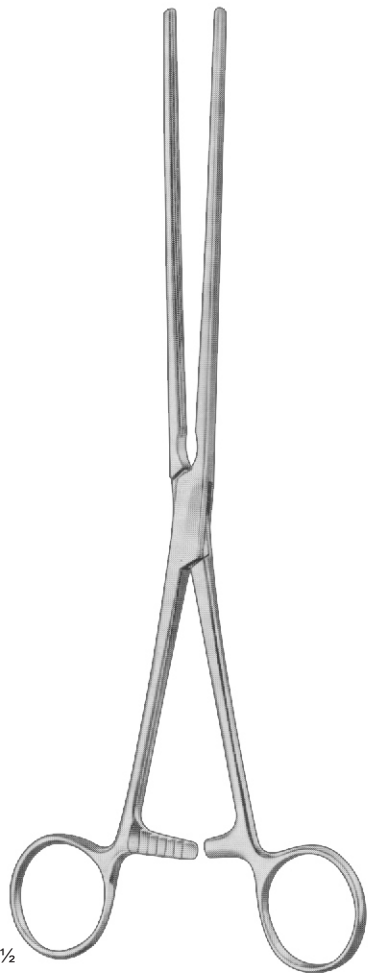

Mayo-Robson-Atrauma

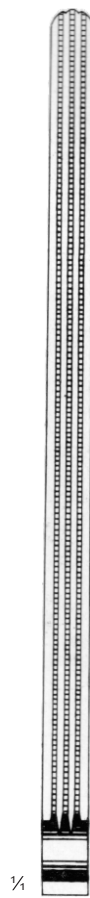

S13.554.250
25 cm / 10"

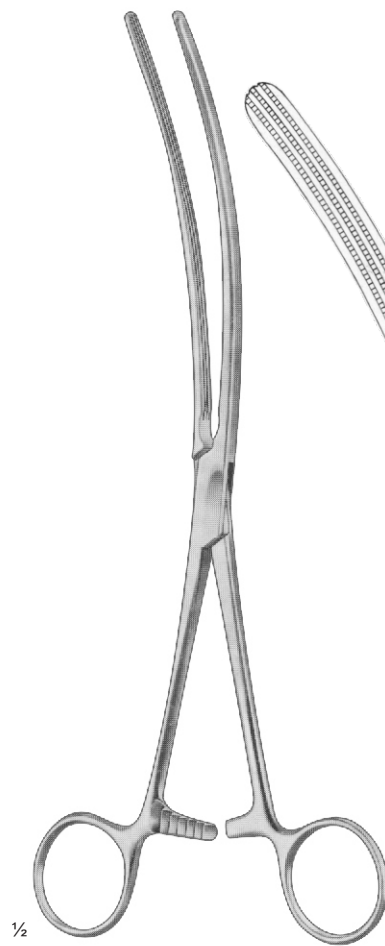

Mayo-Robson-Atrauma

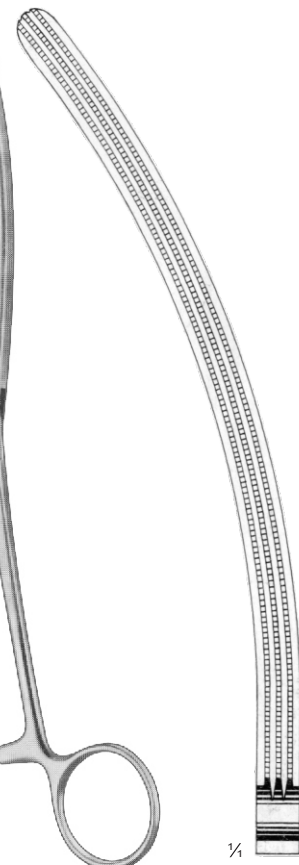

S13.555.250
25 cm / 10"

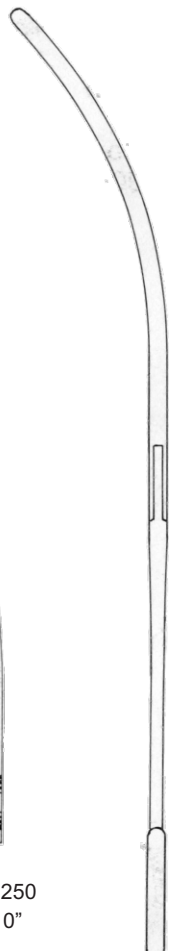

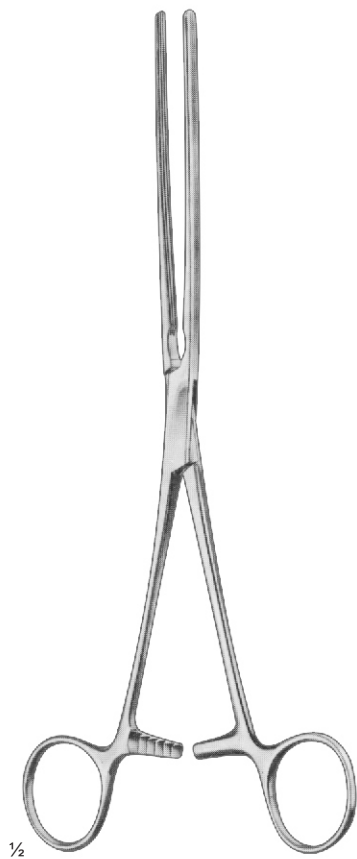

Kocher-Atrauma

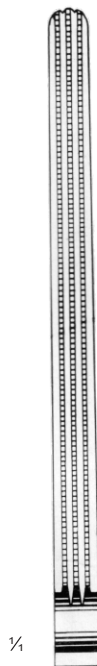

S13.560.220
22 cm / 8³/₄"

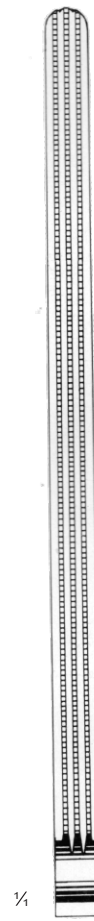

S13.560.250
25 cm / 10"

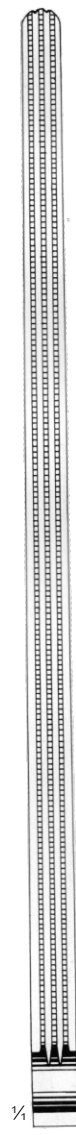

S13.560.280
28 cm / 11"

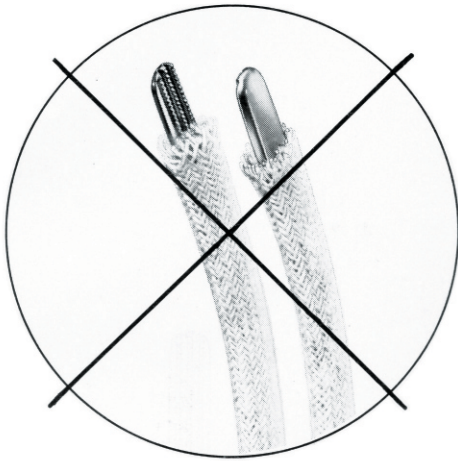

No more time-wasting coating of Jaws
Das zeitraubende Beziehen der Maulteile entfällt
Se evita el engoroso cubrimiento de la boca



1/2

Kocher-Atrauma
S13.561.220 - S13.561.280

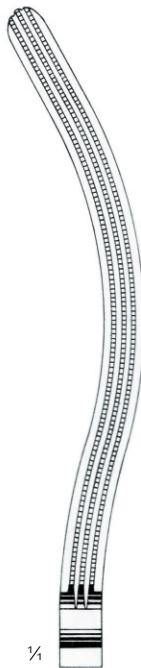

1/4

S13.561.220
22 cm / 8 3/4"

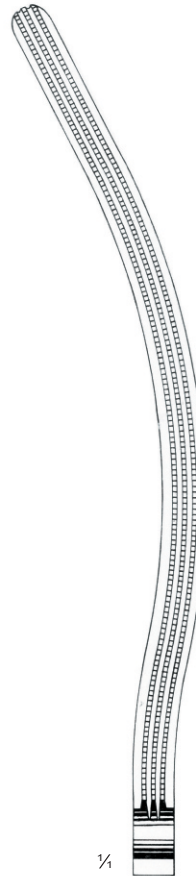

1/4

S13.561.250
25 cm / 10"

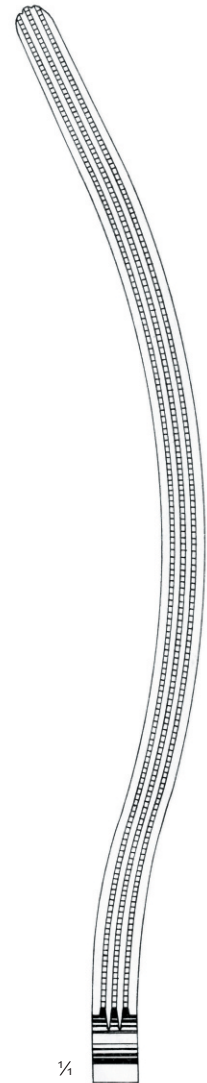

1/4

S13.561.280
28 cm / 11"

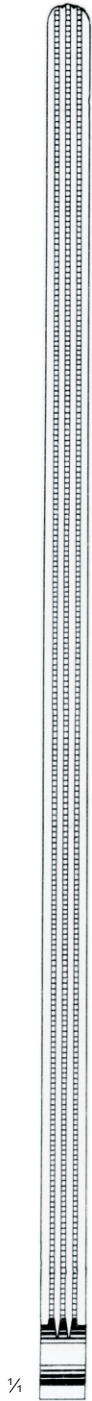

S13.570.330
 33 cm / 12"



Scudder-Atrauma
 S13.580.240 - S13.580.280

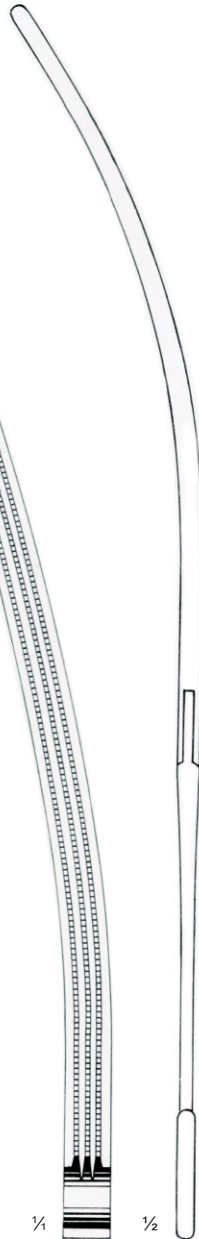

S13.571.330
 33 cm / 12"

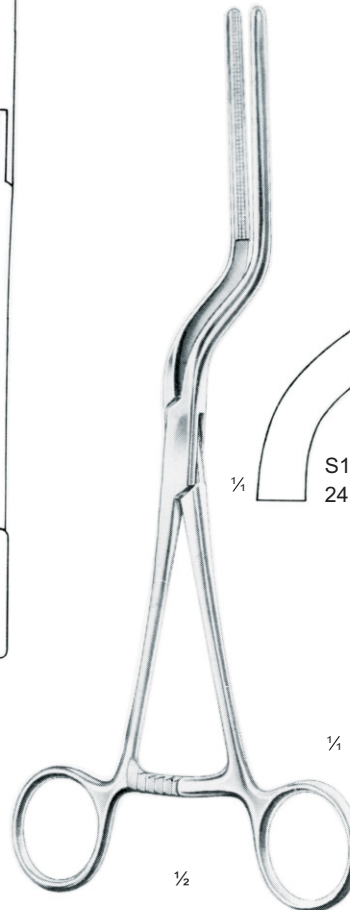

Brunner
 S13.580.240 - S13.580.280

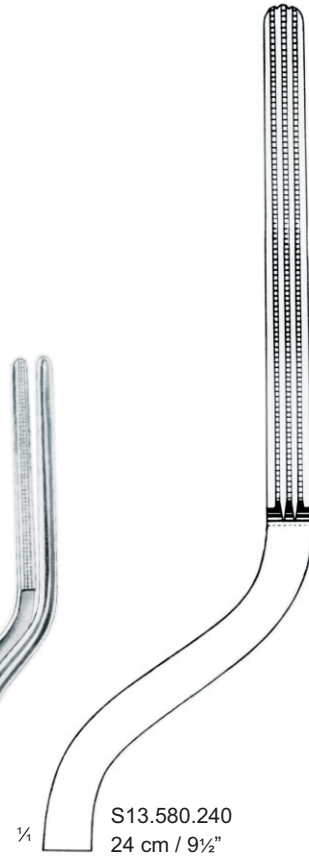

S13.580.240
 24 cm / 9 1/2"

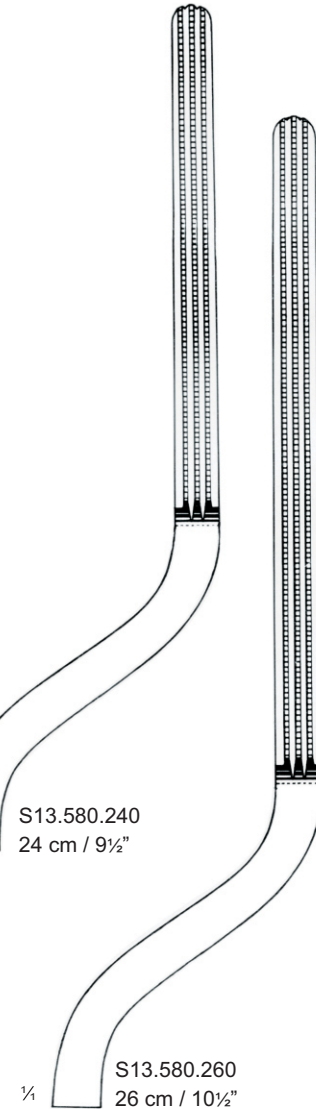

S13.580.260
 26 cm / 10 1/2"

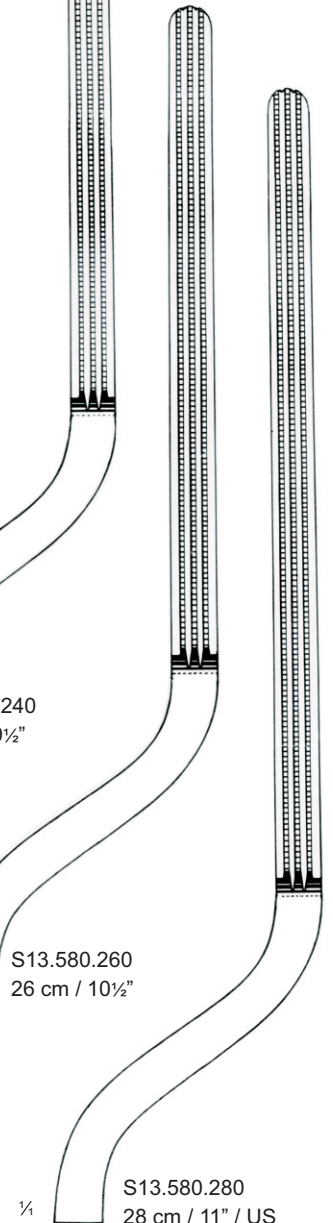

S13.580.280
 28 cm / 11" / US



1/2

Czerny
S13.605.220
22 cm / 8 3/4"

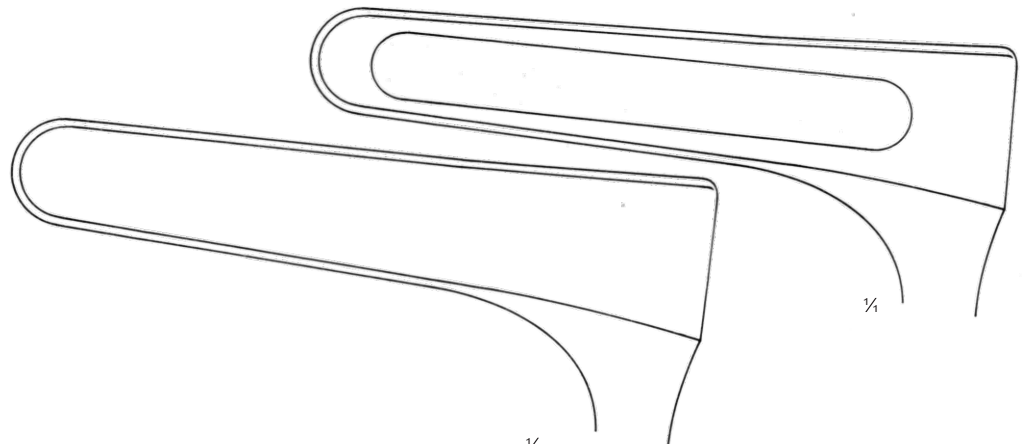

1/4



1/2

Sims
S13.613.150
15 cm / 6"



1/2

Sims
S13.615.150
15 cm / 6"

S13.605.220
S13.613.150-
S13.615.150

- Rectal Speculum
- Rectal Specula with fixing screw

Mastdarm-Spekulum
Mastdarm-Spekula mit Stellschraube

- Espéculo rectal
- Espéculos rectales con tornillos fijadores

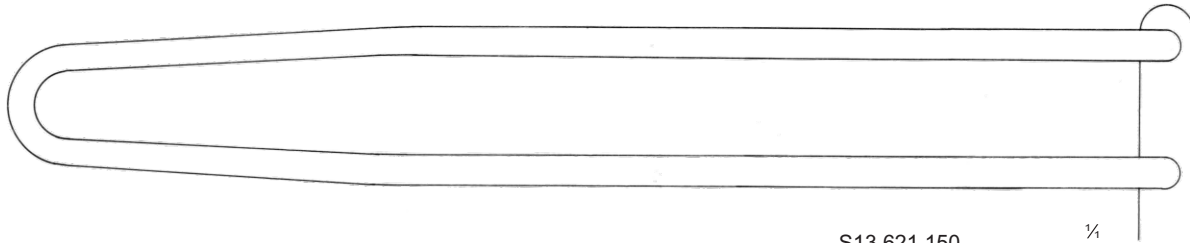

S13.621.150
 Length of Blades 150 mm
 Valvenlänge 150 mm
 Largo de valvas 150 mm

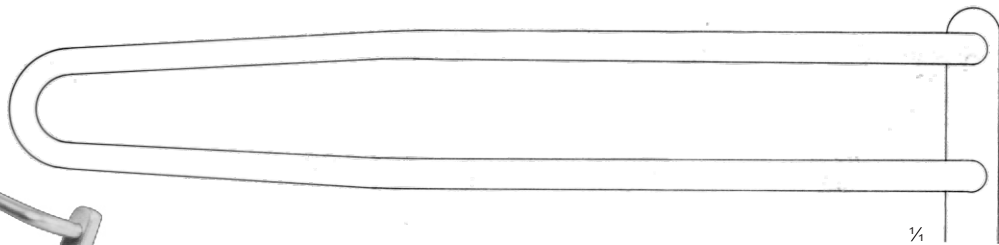

S13.621.125
 Length of Blades 125 mm
 Valvenlänge 125 mm
 Largo de valvas 125 mm

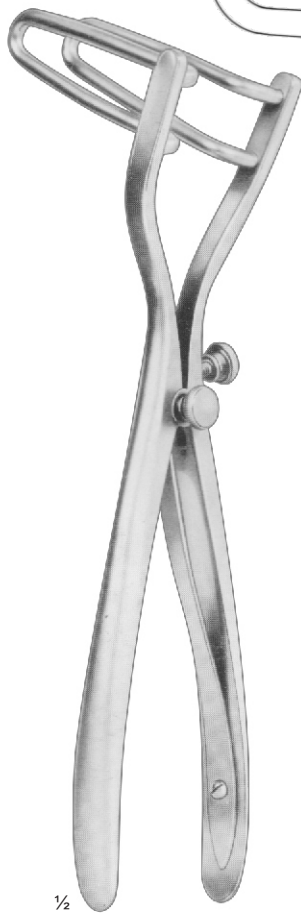

$\frac{1}{2}$
 Schulze-Bergmann
 22 cm / 8 $\frac{1}{2}$ "

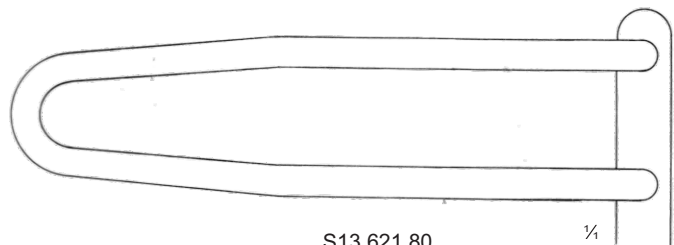

S13.621.80
 Length of Blades 80 mm
 Valvenlänge 80 mm
 Largo de valvas 80 mm

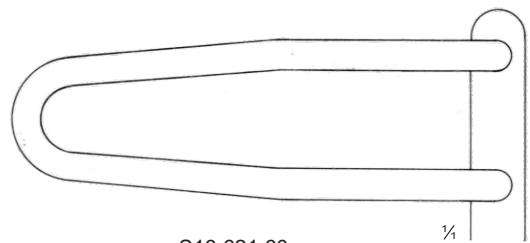

S13.621.60
 Length of Blades 60 mm
 Valvenlänge 60 mm
 Largo de valvas 60 mm

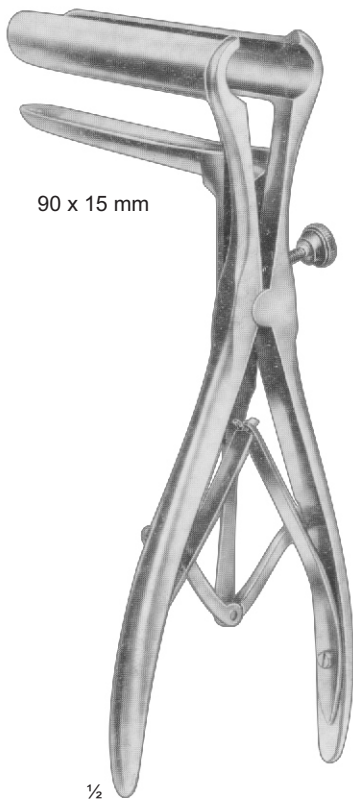

90 x 15 mm

1/2

Mathieu
S13.625.195
19.5 cm / 7 3/4"

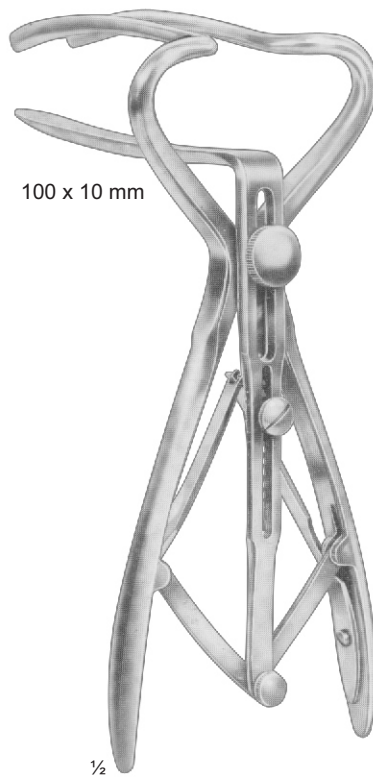

100 x 10 mm

1/2

Cook
S13.631.190
19.0 cm / 7 1/2"

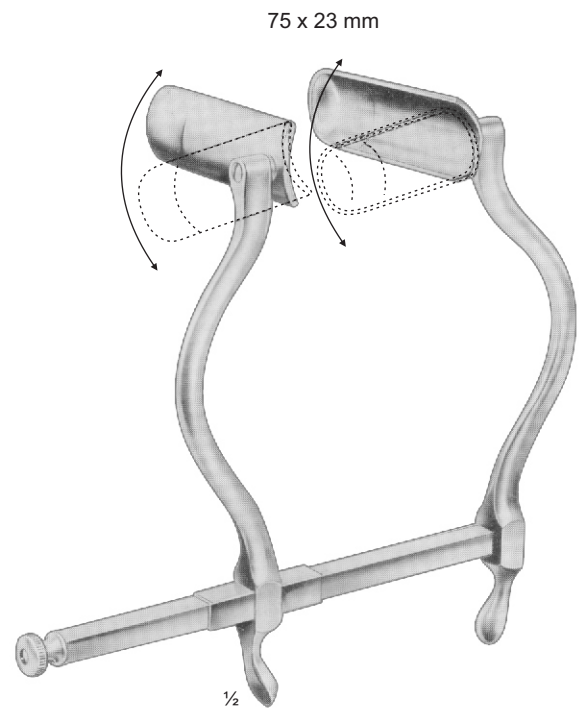

75 x 23 mm

1/2

Smith-Buie
S13.641.150
15 cm / 7 1/2"

S13.625.195 - S13.631.190

- Rectal Specula, three-bladed, with fixing screw

Mastdarm-Spekula, 3blättrig, mit Stellschraube

- Espéculos rectales, tres valvas, con tornillos fijadores

S13.641.150

- Anal Retractor, with swivel blades

Mastdarm-Spreizer, mit beweglichen Blättern

- Espéculo rectal, con valvas movibles

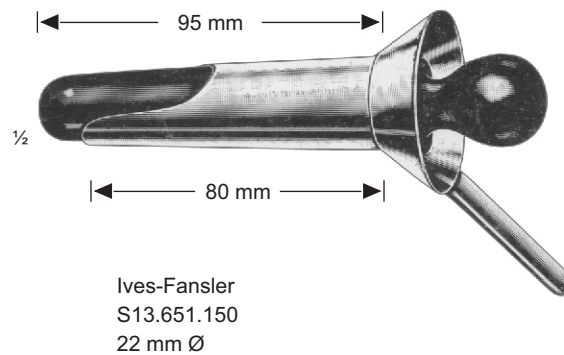
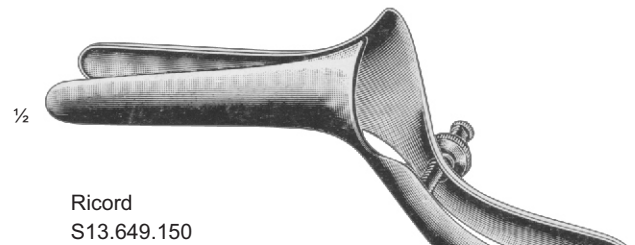

S13.645.170 | - Rectal Speculum with Loktite ratchet
 S13.649.15 | - Rectal Speculum with fixing screw
 S13.651.15 | - Anoscope, with vulcanite obturator

Mastdarm-Spreizer mit Lokite-Sperre
 Mastdarm-Spekulum mit Stellschraube
 Anoskop, mit Hartgummi-Obturator

- Espéculo rectal, con cremallera Loktite
 - Espéculo rectal, con tornillo fijador
 - Anoscopio, con obturador de ebonita



1/2

Hirschmann

- S13.655.01 = Fig. 1 16 mm Ø x 65 mm
- S13.655.02 = Fig. 2 19 mm Ø x 65 mm
- S13.655.03 = Fig. 3 22 mm Ø x 65 mm
- S13.655.04 = Fig. 4 22 mm Ø x 125 mm



1/2

Bensaude

- S13.659.01 = 19 mm Ø x 70 mm
- S13.659.02 = 22 mm Ø x 70 mm

S13.655.01 - S13.655.04
S13.659.01 - S13.659.02

- Anoscopes, with obturators
- ditto, revolving tubes with obturators

Anuskope, mit Obturator
dito, Tubus drehbar, mit Obturator

- Anoscopios, con mandriles
- idem, tubos giratorios con mandriles

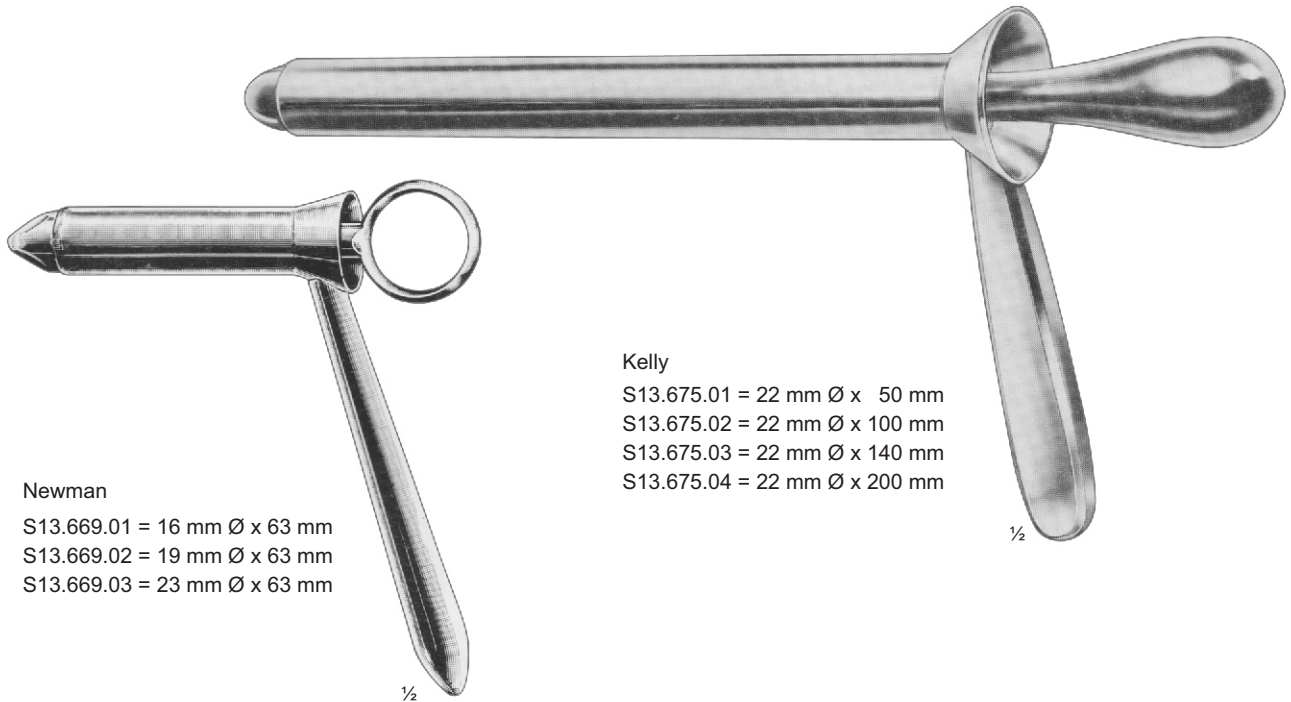

Newman

- S13.669.01 = 16 mm Ø x 63 mm
- S13.669.02 = 19 mm Ø x 63 mm
- S13.669.03 = 23 mm Ø x 63 mm

Kelly

- S13.675.01 = 22 mm Ø x 50 mm
- S13.675.02 = 22 mm Ø x 100 mm
- S13.675.03 = 22 mm Ø x 140 mm
- S13.675.04 = 22 mm Ø x 200 mm



Kelly

- S13.679.01 = 21 mm Ø x 50 mm
- S13.679.02 = 27 mm Ø x 50 mm

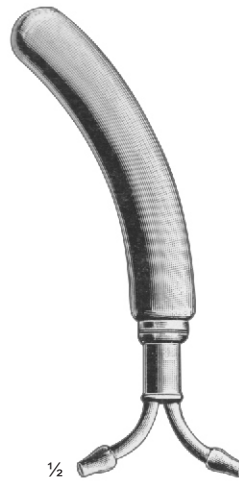

Arzberger

- S13.683.130
- 13 cm / 5"



Katzenstein

- | | |
|------------|------------|
| S13.690.90 | S13.692.80 |
| S13.691.90 | S13.693.80 |
| 9 cm / 3½" | 8 cm / 3¼" |

S13.669.01 - S13.675.04
 S13.679.01 - S13.679.02
 S13.683.130

- Proctoscopes, with obturators
 - Sphincteroscopes, with obturators
 - Rectal cooler

S13.690.90
 S13.691.90
 S13.692.80
 S13.693.80

Drop Cannulas
 - straight, for adults
 - curved, for adults
 - straight, for children
 - curved, for children

Proktoskope, mit Obturator
 Sphinkteroskope, mit Obturator
 Mastdarmkühler
 Tropfkanülen (Darpfpeifen)
 gerade, für Erwachsene
 gebogen, für Erwachsene
 gerade, für Kinder
 gebogen, für Kinder

- Proctoscopios, con mandriles
 - Esfinteroscopios, con mandriles
 - Refrigerador rectal
 - Cánulas cuenta-gotas
 - recta, para adultos
 - curva, para adultos
 - recta, para niños
 - curva, para niños

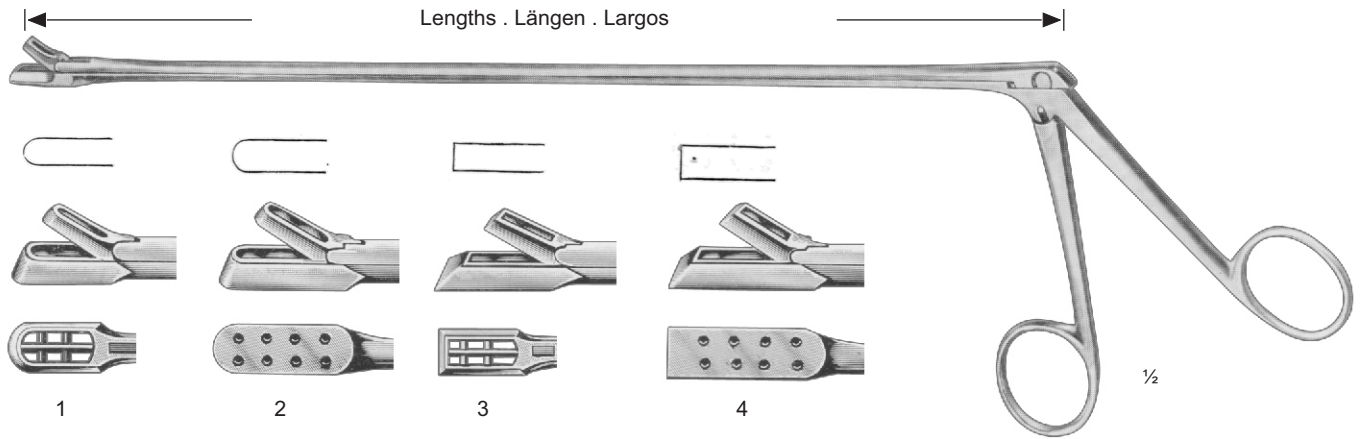

Yeoman

cm	in.	Fig. 1	2	3	4
28	11	S13.721.280	S13.722.280	S13.723.280	S13.724.280
35	13 $\frac{3}{4}$	S13.721.350	S13.722.350	S13.723.350	S13.724.350
42	16 $\frac{1}{2}$	S13.721.420	S13.722.420	S13.723.420	S13.724.420

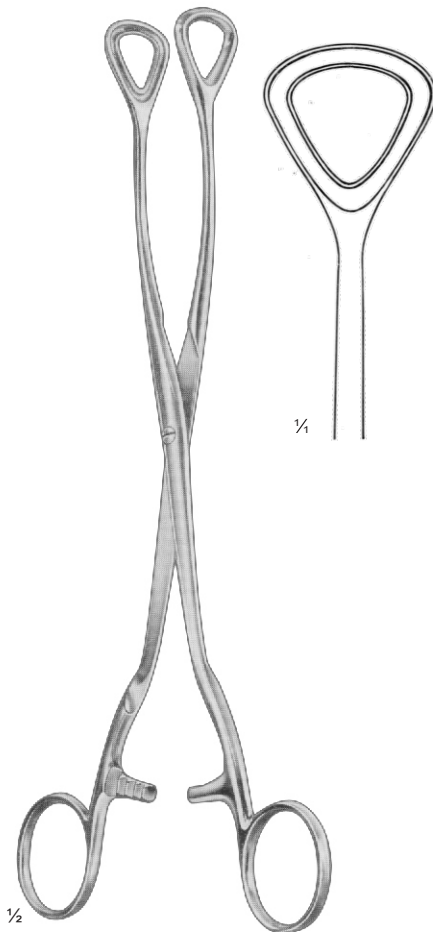

Luer
 S13.750.245
 24.5 cm / 9 $\frac{3}{4}$ "

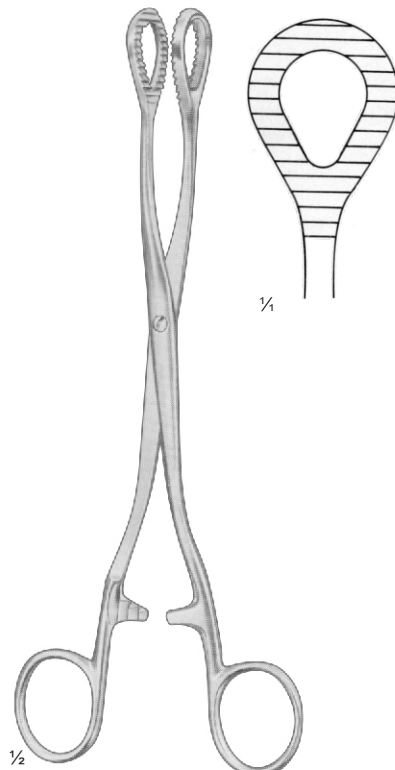

Heywood-Smith
 S13.756.200
 20 cm / 8"

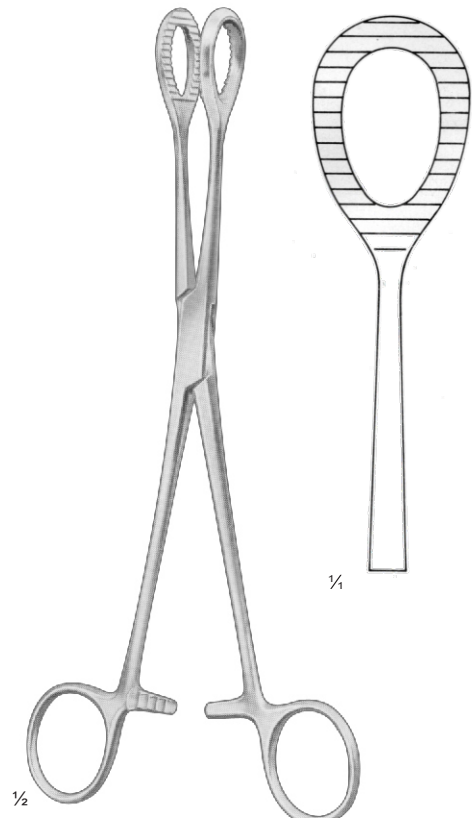

Heywood-Smith
 S13.758.210
 21 cm / 8 $\frac{1}{4}$ "

S13.721.280 - S13.724.420 | - Rectal Biopsy Punch Forceps Mastdarm-Biopsiezangen - Pinzas cortantes para biopsia rectal



acme surgical
www.acmesurgical.com